

User Manual

ZKBio CVSecurity

Version: 1.0.0

Date: November 2022

Software Version: ZKBio CVSecurity_5.2.0 and above

English

Thank you for choosing our product. Please read the instructions carefully before operation. Follow these instructions to ensure that the product is functioning properly. The images shown in this manual are for illustrative purposes only.



For further details, please visit our Company's website
www.zkteco.com.

Copyright © 2022 ZKTECO CO., LTD. All rights reserved.

Without the prior written consent of ZKTeco, no portion of this manual can be copied or forwarded in any way or form. All parts of this manual belong to ZKTeco and its subsidiaries (hereinafter the "Company" or "ZKTeco").

Trademark

ZKTeco is a registered trademark of ZKTeco. Other trademarks involved in this manual are owned by their respective owners.

Disclaimer

This manual contains information on the operation and maintenance of the ZKTeco equipment. The copyright in all the documents, drawings, etc. in relation to the ZKTeco supplied equipment vests in and is the property of ZKTeco. The contents hereof should not be used or shared by the receiver with any third party without express written permission of ZKTeco.

The contents of this manual must be read as a whole before starting the operation and maintenance of the supplied equipment. If any of the content(s) of the manual seems unclear or incomplete, please contact ZKTeco before starting the operation and maintenance of the said equipment.

It is an essential pre-requisite for the satisfactory operation and maintenance that the operating and maintenance personnel are fully familiar with the design and that the said personnel have received thorough training in operating and maintaining the machine/unit/equipment. It is further essential for the safe operation of the machine/unit/equipment that personnel has read, understood and followed the safety instructions contained in the manual.

In case of any conflict between terms and conditions of this manual and the contract specifications, drawings, instruction sheets or any other contract-related documents, the contract conditions/documents shall prevail. The contract specific conditions/documents shall apply in priority.

ZKTeco offers no warranty, guarantee or representation regarding the completeness of any information contained in this manual or any of the amendments made thereto. ZKTeco does not extend the warranty of any kind, including, without limitation, any warranty of design, merchantability or fitness for a particular purpose.

ZKTeco does not assume responsibility for any errors or omissions in the information or documents which are referenced by or linked to this manual. The entire risk as to the results and performance obtained from using the information is assumed by the user.

ZKTeco in no event shall be liable to the user or any third party for any incidental, consequential, indirect, special, or exemplary damages, including, without limitation, loss of business, loss of profits, business interruption, loss of business information or any pecuniary loss, arising out of, in connection with, or relating to the use of the information contained in or referenced by this manual, even if ZKTeco has been advised of the possibility of such damages.

This manual and the information contained therein may include technical, other inaccuracies or

typographical errors. ZKTeco periodically changes the information herein which will be incorporated into new additions/amendments to the manual. ZKTeco reserves the right to add, delete, amend or modify the information contained in the manual from time to time in the form of circulars, letters, notes, etc. for better operation and safety of the machine/unit/equipment. The said additions or amendments are meant for improvement /better operations of the machine/unit/equipment and such amendments shall not give any right to claim any compensation or damages under any circumstances.

ZKTeco shall in no way be responsible (i) in case the machine/unit/equipment malfunctions due to any non-compliance of the instructions contained in this manual (ii) in case of operation of the machine/unit/equipment beyond the rate limits (iii) in case of operation of the machine and equipment in conditions different from the prescribed conditions of the manual.

The product will be updated from time to time without prior notice. The latest operation procedures and relevant documents are available on <http://www.zkteco.com>.

If there is any issue related to the product, please contact us.

ZKTeco Headquarters

Address ZKTeco Industrial Park, No. 32, Industrial Road,
Tangxia Town, Dongguan, China.

Phone +86 769 - 82109991

Fax +86 755 - 89602394

For business related queries, please write to us at: sales@zkteco.com.

To know more about our global branches, visit www.zkteco.com.

About the Company

ZKTeco is one of the world's largest manufacturer of RFID and Biometric (Fingerprint, Facial, Finger-vein) readers. Product offerings include Access Control readers and panels, Near & Far-range Facial Recognition Cameras, Elevator/Floor access controllers, Turnstiles, License Plate Recognition (LPR) gate controllers and Consumer products including battery-operated fingerprint and face-reader door locks. Our security solutions are multi-lingual and localized in over 18 different languages. At the ZKTeco state-of-the-art 700,000 square foot ISO9001-certified manufacturing facility, we control manufacturing, product design, component assembly, and logistics/shipping, all under one roof.

The founders of ZKTeco have been determined for independent research and development of biometric verification procedures and the productization of biometric verification SDK, which was initially widely applied in PC security and identity authentication fields. With the continuous enhancement of the development and plenty of market applications, the team has gradually constructed an identity authentication ecosystem and smart security ecosystem, which are based on biometric verification techniques. With years of experience in the industrialization of biometric verifications, ZKTeco was officially established in 2007 and now has been one of the globally leading enterprises in the biometric verification industry owning various patents and being selected as the National High-tech Enterprise for 6 consecutive years. Its products are protected by intellectual property rights.

About the Manual

This manual introduces the operations of **ZKBioCVSecurity**.

All figures displayed are for illustration purposes only. Figures in this manual may not be exactly consistent with the actual products.

Document Conventions

Conventions used in this manual are listed below:

GUI Conventions

For Software	
Convention	Description
Bold font	Used to identify software interface names e.g. OK , Confirm , Cancel .
>	Multi-level menus are separated by these brackets. For example, File > Create > Folder.
For Device	
Convention	Description
< >	Button or key names for devices. For example, press <OK>.
	Window names, menu items, data table, and field names are inside square brackets. For example, pop up the New User window.
/	Multi-level menus are separated by forwarding slashes. For example, File/Create/Folder.

Symbols





Convention	Description
	This represents a note that needs to pay more attention to.
	The general information which helps in performing the operations faster.
	The information which is significant.
	Care taken to avoid danger or mistakes.
	The statement or event that warns of something or that serves as a cautionary example.

TABLE OF CONTENTS

1	INSTALLATION AND LOGIN	18
1.1	OPERATING ENVIRONMENT REQUIREMENTS	18
1.2	SYSTEM INSTALLATION	19
2	PERSONNEL	21
2.1	PERSONNEL MANAGEMENT	21
2.1.1	PERSON	22
2.1.2	DEPARTMENT	38
2.1.3	POSITION	40
2.1.4	DISMISSED PERSONNEL	42
2.1.5	PENDING REVIEW	43
2.1.6	CUSTOM ATTRIBUTES	43
2.1.7	LIST LIBRARY	45
2.1.8	PARAMETERS	46
2.2	CARD MANAGEMENT	49
2.2.1	CARD	49
2.2.2	WEIGAND FORMAT	51
2.2.3	ISSUE CARD RECORD	54
3	ACCESS CONTROL	55
3.1	OPERATION SCENARIO	55
3.2	OPERATION PROCESS	55
3.3	ACCESS DEVICE	56
3.3.1	DEVICE	56
3.3.2	DOOR	65
3.3.3	READER	68
3.3.4	AUXILIARY INPUT	69
3.3.5	AUXILIARY OUTPUT	70
3.3.6	EVENT TYPE	71
3.3.7	DAYLIGHT SAVING TIME	73
3.3.8	DEVICE MONITORING	74
3.3.9	REAL-TIME MONITORING	76
3.3.10	ALARM MONITORING	80
3.3.11	MAP	81
3.4	ACCESS RULE	82
3.4.1	TIMEZONE	82
3.4.2	HOLIDAY	84
3.4.3	ACCESS LEVEL	85
3.4.4	SET ACCESS LEVEL ALLOCATION	91

3.4.5	SET ACCESS LEVEL GROUPS BY PERSON	93
3.4.6	SET ACCESS LEVEL GROUPS BY DEPARTMENT	95
3.4.7	INTERLOCK	96
3.4.8	LINKAGE	97
3.4.9	ANTI-PASSBACK	100
3.4.10	THE FIRST-PERSON NORMALLY OPEN	101
3.4.11	MULTI-PERSON GROUP	103
3.4.12	MULTI-PEOPLE OPEN THE DOOR	105
3.4.13	VERIFICATION MODE	107
3.4.14	PARAMETERS	108
3.5	ADVANCED FUNCTION	110
3.5.1	ENTRANCE GUARD AREA(ZONE)	110
3.5.2	READER DEFINITION	112
3.5.3	WHO IS INSIDE	114
3.5.4	GLOBAL ANTI-PASSBACK	115
3.5.5	GLOBAL LINKAGE	117
3.5.6	THE GLOBAL INTERLOCK GROUP	119
3.5.7	THE GLOBAL INTERLOCK	121
3.5.8	PERSONNEL AVAILABILITY	122
3.5.9	OCCUPANCY CONTROL	124
3.5.10	MUSTER POINT	125
3.5.11	MUSTER POINT SETTING	129
3.6	ACCESS CONTROL REPORTS	131
3.6.1	ALL TRANSACTIONS	132
3.6.2	EVENTS FROM TODAY	133
3.6.3	ALL EXCEPTION EVENTS	134
3.6.4	ACCESS RIGHTS BY DOOR	135
3.6.5	ACCESS RIGHTS BY PERSONNEL	136
3.6.6	FIRST IN AND LAST OUT	137
4	VIDEO MANAGEMENT	138
4.1	VIDEO VIEW	138
4.1.1	VIDEO PREVIEW	138
4.1.2	VIDEO PLAYBACK	142
4.2	DEVICE MANAGEMENT	142
4.2.1	DEVICE (ADD DEVICE)	142
4.2.2	CAMERA	145
4.2.3	GROUP MANAGEMENT	157
4.3	DECODING ON THE WALL	157
4.3.1	DECODER	158

4.3.2	TV WALL.....	158
4.3.3	LARGE SCREEN CONTROL.....	160
4.4	SEARCH.....	161
4.4.1	FACE SEARCH.....	161
4.4.2	VEHICLE RETRIEVAL (AS1700).....	163
4.4.3	TARGET COMPARISON (AS1700).....	164
4.4.4	SEARCH FOR PICTURES WITH PICTURES.....	164
4.4.5	PERSONNEL FREQUENCY RETRIEVAL (NVR800).....	165
4.5	INTELLIGENT.....	166
4.5.1	ALGORITHM MODEL (AS1700 SUPPORTED).....	166
4.5.2	TARGET INTELLIGENCE.....	166
4.5.3	BEHAVIOR ANALYSIS (AS1700 SUPPORTED).....	170
4.5.4	CROWD SITUATION.....	181
4.5.5	GENERAL INTELLIGENCE (AS1700/ZKNVR SUPPORTED).....	186
4.5.6	VEHICLE INTELLIGENCE (AS1700 SUPPORTED).....	190
4.5.7	INTELLIGENT APPLICATION.....	190
4.6	STATISTICS.....	192
4.6.1	FACE ANALYSIS.....	192
4.6.2	FACE REPORT.....	193
4.6.3	CROSS-LINE STATISTICS.....	194
4.6.4	HEAT MAP.....	195
4.6.5	OBJECT STATISTICS.....	196
4.6.6	ALARM REPORT.....	197
4.6.7	PATROL REPORT.....	198
4.6.8	PATROL ALARM.....	199
4.7	VIDEO PATROL.....	200
4.7.1	PATROL GROUP.....	200
4.7.2	PATROL PLAN.....	201
4.7.3	REAL-TIME PATROL.....	204
4.8	MAINTENANCE CONFIGURATION (AS1700 SUPPORTED).....	207
4.8.1	DEVELOPER LOG.....	207
4.8.2	CLIENT REQUEST LOG.....	208
4.8.3	CU REQUEST.....	209
4.8.4	PARAMETERS.....	210
4.9	VIDEO INTERCOM.....	211
4.9.1	VIDEO INTERCOM EQUIPMENT.....	211
4.9.2	CALL RECORDS.....	214
5	INTELLIGENT ANALYSITS.....	215
5.1	SCENE APPLICATION.....	215

5.1.1	TARGET SEARCH	215
5.1.2	PERSONNEL CONTROL	217
5.1.3	TAILING DETECTION	221
5.1.4	PERIMETER PROTECTION	222
5.1.5	ATTANDANCE CHECKING DETECTION	225
5.1.6	PEOPLE COUNTING	227
5.1.7	LIVE ALARM	229
5.1.8	MY DASHBOARD	229
5.2	DEVICE MANAGEMENT	231
5.2.1	IPC CONNECTION (CURRENTLY, ONLY SUPPORT HWSDK CAMERA CONNECTION, PLEASE CHECK THE HARDWARE SUGGESTION LIST)	231
5.2.2	ZKIVA-EDGE CONNECTION (CURRENTLY, ONLY SUPPORT ZKIVA-EDGE T1 CONNECTION) (SMART BOX)	233
5.3	SERVICE CONFIGURATION	238
5.3.1	TIMEZONE	238
5.3.2	APPLICATION CONFIGURATION	239
5.3.3	REGIONAL OCCUPANCY CONTROL CONFIGURATION	240
5.3.4	LIVE ALARM CONFIGURATION	241
5.3.5	CUSTOM ICON	242
5.3.6	DASHBOARD CONFIGURATION	242
5.3.7	PARAMETERS	244
5.4	REPORTS	245
5.4.1	ALL RECORDS	245
5.4.2	ENTRY & EXIT RECORDS	245
5.4.3	TREND REPORTS	246
5.4.4	LIVE ALARM QUERY	246
5.4.5	DISMISSAL REPORT	247
6	ATTENDANCE MANAGEMENT	248
6.1	OPERATION SCENARIO	248
6.2	OPERATION FLOW	248
6.3	ATTENDANCE MANAGEMENT	248
6.3.1	BY AREA	248
6.3.2	ATTENDANCE DEVICE DESCRIPTION (ATTENDANCE DEVICE)	251
6.3.3	ATTENDANCE POINT	253
6.3.4	ROLL CALL	254
6.3.5	COMMAND FROM SERVER	255
6.3.6	DEVICE OPERATION LOG	255
6.4	ATTENDANCE SETTING	256
6.4.1	ATTENDANCE RULE SETTING	256
6.4.2	HOLIDAYS	261

6.4.3	LEAVE TYPE	262
6.4.4	AUTOMATIC REPORT	263
6.4.5	PROCESS SETTINGS	264
6.5	REGULAR SHIFT SETTING SCHEDULE	265
6.5.1	TIMETABLE	265
6.5.2	PERSONNEL SCHEDULE	269
6.5.3	GROUP SCHEDULE	271
6.5.4	SCHEDULE DETAILS	274
6.6	EXCEPTION	275
6.6.1	APPENDED LOG	275
6.6.2	ASK FOR LEAVE	276
6.6.3	OVERTIME	277
6.6.4	ADJUST REST	278
6.6.5	SHIFT ADJUSTMENT	279
6.7	ATTENDANCE DETAIL REPORT	280
6.7.1	MANUAL CALCULATION	280
6.7.2	ATTENDANCE TRANSACTION	281
6.7.3	DAILY ATTENDANCE	282
6.7.4	DAILY REPORT	283
6.7.5	MONTHLY DETAIL REPORT	284
6.7.6	APPENDED LOG DETAILS	285
6.7.7	LEAVE DETAILS	285
6.7.8	EXCEPTION REPORT	286
6.7.9	WORK TIME REPORT	286
6.7.10	ANNUAL LEAVE BALANCE SHEET	287
6.8	CALCULATE REPORT	287
6.8.1	LEAVE SUMMARY	287
6.8.2	MONTHLY STAFF REPORT	288
6.8.3	MONTHLY DEPARTMENTAL	288
6.8.4	ROLL CALL REPORT	289
7	CONSUMPTION	290
7.1	CONSUMPTION BASIC INFORMATION	290
7.1.1	PIECEWISE FIXED VALUE	291
7.1.2	CONSUMPTION TIME ZONE	292
7.1.3	RESTAURANT INFORMATION	293
7.1.4	MEAL INFORMATION	294
7.1.5	COMMODITY INFORMATION	294
7.1.6	KEY VALUE INFORMATION	296
7.1.7	CARD INFORMATION	296

7.2	CONSUMPTION DEVICE	298
7.2.1	CONSUMPTION DEVICE	298
7.2.2	CONSUMPTION PARAMETER	300
7.3	CONSUMPTION CARD MANAGEMENT	301
7.3.1	CARD SERVICE	301
7.3.2	CARD MANAGEMENT	306
7.3.3	INCOME AND EXPENSES	307
7.4	CONSUMPTION DETAIL	308
7.4.1	CONSUMPTION DETAIL REPORT	308
7.4.2	CONSUMPTION EXCEPTION REPORT	310
7.5	MANUAL SUPPLEMENT	310
7.5.1	MANUAL SUPPLEMENT	311
7.6	SUBSIDY	311
7.6.1	SUBSIDY REGISTRATION	312
7.6.2	ONE- CLICK REVIEW	312
7.6.3	REVIEW	313
7.6.4	REISSUE THE COMMAND	313
7.6.5	DELETE	313
7.6.6	IMPORT	313
7.6.7	MORE	314
7.6.8	EXPORT	314
7.6.9	DOWNLOAD TEMPLATE	314
7.7	CONSUMPTION REPORT	315
7.7.1	ISSUE CARD REPORT	315
7.7.2	TOP UP REPORT	316
7.7.3	REFUND REPORT	316
7.7.4	SUBSIDY REPORT	317
7.7.5	REPORT OF RETURN CARD	317
7.7.6	CARD COST REPORT	318
7.7.7	CARD BALANCE REPORT	318
7.7.8	NON-CARD RETURN CARD REPORT	319
7.7.9	REPORT OF RESUME THE CARD	319
7.8	CONSUMPTION STATISTICS	320
7.8.1	PERSONAL CONSUMPTION REPORT	320
7.8.2	DEPARTMENT SUMMARY	321
7.8.3	RESTAURANT SUMMARY	321
7.8.4	DEVICE SUMMARY	322
7.8.5	INCOME AND EXPENSES REPORT	322
7.8.6	MEAL SUMMARY	323

8	ELEVATOR CONTROL MANAGEMENT	324
8.1	OPERATION SCENARIO	324
8.2	OPERATION FLOW	324
8.3	ELEVATOR DEVICE	324
8.3.1	MANUALLY ADD ELEVATOR CONTROL DEVICE (DEVICE)	324
8.3.2	EXPANDING BOARD	329
8.3.3	READER	330
8.3.4	FLOOR FLOOR SETTING	330
8.3.5	AUXILARY INPUT	332
8.3.6	EVENT TYPE	333
8.3.7	DEVICE MONITORING	333
8.3.8	REAL TIME MONITORING	334
8.4	ELEVATOR CONTROL RULES	336
8.4.1	TIME PERIOD SETTING TIME ZONES	336
8.4.2	HOLIDAY SETTING	338
8.4.3	ELEVATOR LEVELS	339
8.4.4	SET ACCESS BY LEVELS	340
8.4.5	SET ACCESS BY PERSON	340
8.4.6	SET ACCESS BY DEPARTMENT	341
8.4.7	DIRECT SELECTION SET	342
8.4.8	LINKAGE SETTING GLOBAL LINKAGE	342
8.4.9	PARAMETERS	343
8.5	ELEVATOR CONTROL REPORTS	344
8.5.1	ALL TRANSACTION	344
8.5.2	ALL EXCEPTION EVENTS	345
8.5.3	ACCESS RIGHTS BY FLOOR	345
8.5.4	ACCESS RIGHTS BY PERSONNEL	346
8.5.5	FIRST IN AND LAST OUT	347
9	PARKING MANAGEMENT	348
9.1	OPERATION SCENARIO	348
9.2	OPERATION FLOW	348
9.3	BASIC PARKING SETTING	349
9.3.1	PARKING SETTINGS	349
9.3.2	DEVICE	351
9.3.3	PARKING AREA	352
9.3.4	ENTRANCE AND EXIT AREA	353
9.3.5	GUARD BOOTH	354
9.3.6	CHANNEL	355
9.3.7	VECHICLE DEFINITION	357

9.3.8	SHIFT SETTINGS	358
9.3.9	MANUAL RELEASE REASON	359
9.4	CHARGE MANAGEMENT	360
9.4.1	FIXED CARS ARE CHARGING RULES	360
9.4.2	TEMPORARY CAR CHARGING RULES	361
9.4.3	OVERTIME CHARGING RULES	363
9.4.4	DISCOUNT STRATEGY	364
9.4.5	BUSINESS MANAGEMENT	365
9.4.6	FINANCIAL RECONCILIATION	366
9.5	VECHICLE MANAGEMENT	367
9.5.1	LICENSE PLATE REGISTRATION	367
9.5.2	VEHICLE AUTHORIZATION	369
9.5.3	FIXED VECHICLE EXTENSION	371
9.5.4	BLOCK&ALLOW LIST MANAGEMENT	372
9.6	REPORT MANAGEMENT	373
9.6.1	VECHICLE INSIDE	373
9.6.2	ENTRY RECORD	374
9.6.3	EXIT RECORD	374
9.6.4	CHARGE RECORD	374
9.6.5	EXPIRED VEHICLE	375
9.6.6	FIXED VEHICLE AUTHORIZATION RECORD	375
9.6.7	DEVICE OPREATION RECORD	376
9.6.8	HANDOVER STATISTICS	376
9.6.9	DAILY INCOME STATISTICS	377
9.6.10	MONTHLY INCOME STATISTICS	377
9.7	REAL-TIME MONITORING	378
9.7.1	SENTRY BOOTH MONITORING	378
9.7.2	MONITOR ROOM	380
10	VISITOR MANAGEMENT	382
10.1	OPERATION SCENARIO	382
10.2	OPERATION FLOW	382
10.3	VISITOR REGISTRATION	382
10.3.1	ENTRY REGISTRATION	382
10.3.2	VISITOR	389
10.4	VISITOR RESERVATION	392
10.4.1	VISITOR RESERVATION	392
10.4.2	RESERVATION AUDIT	395
10.4.3	INVITE	396
10.4.4	RESPONDENT SELF-APPROVAL	398

10.5	BASIC MANAGEMENT	403
10.5.1	PARAMETERS	403
10.5.2	DEVICE DEBUGGING	406
10.5.3	PRINT SETTINGS	407
10.5.4	VISITOR LEVELS	409
10.5.5	VISITOR COMMON PERMISSION GROUP	413
10.5.6	HOST LEVEL	416
10.5.7	SET UP PERMISSION GROUPS BY VISITED DEPARTMENT (VISITED DEPARTMENT LEVEL)	419
10.5.8	ENTRY PLACE	421
10.5.9	VISIT REASON	425
10.5.10	CUSTOM ATTRIBUTES	426
10.6	ADVANCED	427
10.6.1	CATEGORY	427
10.6.2	WATCHLIST	429
10.6.3	WATCH LIST THUMBNAILS	431
10.6.4	ALERT TEMPLATE	432
10.6.5	LINKAGE	433
10.7	VISITOR REPORTS	435
10.7.1	LAST VISITED LOCATION	435
10.7.2	VISITOR HISTORY RECORD	436
11	PATROL MANAGEMENT	438
11.1	OPERATION SCENARIO	438
11.2	OPERATION FLOW	438
11.3	PATROL ROUTE MONITORING	438
11.3.1	PATROL MONITORING	438
11.4	BASIC SETTINGS (PATROL BASIC MANAGEMENT)	439
11.4.1	DEVICE ADDITION (DEVICE)	439
11.4.2	CHECKPOINT	440
11.4.3	PARAMETERS	441
11.5	PATROL MANAGEMENT	442
11.5.1	SET UP A PATROL PLAN	442
11.5.2	DESIGNATED PATROL PERSONNEL GROUP (PATROL GROUP)	443
11.5.3	SET UP PATROL ROUTES (ROUTE)	444
11.6	RESULT VALIDATION(PATROL REPORTS)	446
11.6.1	ALL TRANSACTIONS	446
11.6.2	PATROL RECORDS TODAY	448
11.6.3	PATROL ROUTE STATISTICS	449
11.6.4	PATROL PERSONNEL STATISTICS	449
12	ENTRANCE CONTROL	451

12.1	OPERATION SCENARIO	451
12.2	OPERATION FLOW	451
12.3	CHANNEL DEVICE	452
12.3.1	PASSAGE	452
12.3.2	DEVICE	453
12.3.3	GATE	460
12.3.4	READER	461
12.3.5	AUXILIARY INPUT	462
12.3.6	EVENT TYPE	462
12.3.7	DAYLIGHT SAVING TIME	463
12.3.8	DEVICE MONITORING	465
12.3.9	REAL-TIME MONITORING	466
12.4	ENTRANCE CONTROL	467
12.4.1	BARRIER GATE PERMISSION GROUP	467
12.4.2	SET ACCESS BY LEVELS	470
12.4.3	ANTI-PASSBACK	471
12.4.4	LINKAGE SETTING	472
12.4.5	PARAMETERS	474
12.5	PASSAGE SETTINGS	475
12.5.1	BARRIER GATE PASSING RULES	475
12.5.2	FLAP BARRIER	477
12.5.3	SWING BARRIER	478
12.6	CHANNEL REPORTS	479
12.6.1	ALL TRANSACTIONS	479
12.6.2	TODAY'S ACCESS RECORD	480
12.6.3	PERSONNEL LAST ACCESS LOCATION	481
12.6.4	ALL EXCEPTION EVENTS	482
13	TEMPERATURE DETECTION	484
13.1	OPERATION SCENARIO	484
13.2	OPERATION FLOW	484
13.3	SETTING OF EPIDEMIC PREVENTION PARAMETERS	484
13.4	TEMPERATURE MANAGEMENT	487
13.4.1	REAL-TIME MONITORING	487
13.4.2	STATISTIC PANEL	487
13.4.3	TEMPERATURE RAW RECORD	488
13.4.4	INDIVIDUAL TEMPERATURE RECORD	490
13.4.5	ABNORMAL TEMPERATURE RECORD	491
13.4.6	DEPARTMENT DAILY STATISTICS	492
13.4.7	MONTHLY STATISTICS	494

13.4.8	AUTOMATIC REPORT	494
13.4.9	PARAMETERS	497
14	SERVICE CENTER	498
14.1	DEVICE CENTER	498
14.1.1	DEVICE	498
14.2	EVENT CENTER	498
14.2.1	THE EVENT TYPE	498
14.2.2	THE EVENT RECORD	499
14.3	NOTIFICATION CENTER	499
14.4	THE MAP CENTER	500
14.4.1	REAL-TIME MONITORING	500
14.4.2	MAP CONFIGURATION	503
14.5	PUSH CENTER	508
14.5.1	PUSH CONFIGURATION	508
14.5.2	PUSH EXCEPTION RECORD	509
15	SYSTEM MANAGEMENT	510
15.1	SYSTEM MANAGEMENT	510
15.1.1	OPERATION LOG	510
15.1.2	DATABASE MANAGEMENT	511
15.1.3	AREA SETTINGS	513
15.1.4	E-MAIL MANAGEMENT	514
15.1.5	DICTIONARY MANAGEMENT	515
15.1.6	DATA CLEANING	516
15.1.7	AUDIO FILE	518
15.1.8	CERTIFICATE TYPE	519
15.1.9	PRINT TEMPALATE	520
15.1.10	SYSTEM MONITORING	521
15.1.11	PARAMETERS	524
15.2	AUTHORITY MANAGEMENT	525
15.2.1	USER	525
15.2.2	ROLE	526
15.2.3	API AUTHORIZATION	527
15.2.4	CLIENT REGISTER	529
15.2.5	SECURITY PARAMETERS	530
15.3	COMMUNICATION MANAGEMENT	532
15.3.1	DEVICE COMMANDS	532
15.3.2	COMMUNICATION DEVICE	533
15.3.3	PRODUCT	534
15.3.4	AUTHORIZED DEVICE	535

15.3.5	COMMUNICATION MONITOR.....	536
15.4	THIRD PARTY INTEGRATION.....	537
15.4.1	LED DEVICE.....	537
15.4.2	DIGIFORT CAMERA.....	541
15.4.3	LINE NOTIFICATION.....	542
15.4.4	AD MANAGEMENT.....	545
15.4.5	SMS MANAGEMENT.....	547
16	FACEKIOSK.....	548
16.1	FACEKIOSK DEVICE.....	548
16.1.1	DEVICE.....	548
16.1.2	SET ATTENDANCE BY AREA.....	549
16.1.3	SET ATTENDANCE BY PERSON.....	550
16.2	MEDIA ADVERTISEMENT RESOURCES.....	551
16.2.1	ADVERTISEMENT RESOURCES.....	551
16.2.2	ADVERTISEMENT SETTINGS.....	551
16.3	FACEKIOSK REPORTS.....	552
16.3.1	VERIFICATION RECORD.....	552
17	HOTEL SYSTEM.....	553
17.1	DEVICE MANAGEMENT.....	553
17.1.1	DEVICE.....	553
17.2	ROOM MANAGEMENT.....	555
17.2.1	ROOM MONITOR.....	555
17.2.2	RESERVATION.....	555
17.2.3	RESERVATION LIST.....	556
17.3	CARD MANAGEMENT.....	559
17.3.1	READ CARD.....	559
17.3.2	CANCEL CARD.....	559
17.3.3	SETTING CARD.....	560
17.4	HOTEL MANAGEMENT.....	562
17.4.1	HOTEL SETTINGS.....	562
17.4.2	ROOM TYPES.....	564
17.4.3	ROOM.....	565
17.4.4	HOTEL FACILITY.....	566
17.4.5	BOOKING METHODS.....	566
17.5	REPORT MANAGEMENT.....	568
17.5.1	GUEST CHECK-IN REPORT.....	568
17.5.2	ROOM OCCUPANCY REPORT.....	569
17.5.3	ROOM CHARGES REPORT.....	570
17.5.4	ISSUE CARD REPORT.....	570

17.5.5	WRITE CARD RECORD REMOTLY	571
17.5.6	UNLOCK LOG REPORT	572
17.5.7	DEVICE COMMAND LIST	572
17.5.8	LOST CARD LIST	573
18	INTRUSION	574
18.1	INTRUSION DEVICE	574
18.1.1	DEVICE	574
18.1.2	PARTITION	577
18.1.3	ZONE	579
18.1.4	DEVICE USER	580
18.2	REAL-TIME MONITORING	582
18.3	INTRUSION RECORD	583
19	LOCKER	585
19.1	LOCKER DEVICE MANAGEMENT	585
19.1.1	DEVICE	585
19.1.2	PARAMETERS	588
19.1.3	VISUAL PANEL	589
19.2	LOCKER REPORT	590
19.2.1	ALL TRANSACTION	590

1 Installation And Login

1.1 Operating Environment Requirements

Category	Minimum Configuration Requirements
CPU	At least Intel quad-core (above intel core i5-6600)
RAM	Not less than 8GB
Hard Disk	Not less than 500GB (the remaining space of the system disk is more than 15GB)
OS	Support 64-bit Windows 7 Professional Edition, 64-bit Windows 10 OS
Graphics Card	Intel integrated graphics, video memory greater than 2.0G (Intel® HD Graphics 530 and above recommended)
Network Card	At least one network card, the recommended network speed is not less than 1000Mbit/s
Monitor	At least 21.5 inches, and the best resolution of the monitor is recommended: 1920 * 1080. It is recommended to set the display resolution to 1920 * 1080. Using other resolutions may cause the interface to be abnormal.
Browser	Support Chrome33+ (recommended)/Firefox27+/Explorer11+

Table 1- 1

Instruction:

The number of live channels supported under the minimum configuration requirements:

Resolution	Configuration a (H.264 format)	Configuration a (H.265 format)
CIF (512K)	38	38
4CIF/D1 (2M)	22	22
720P (2M 25fps)	10	10
1080P (4M 25fps)	6	6

Table 1- 2

In the video preview window, you can view the system CPU or memory usage in real time. If the CPU reaches 80%, it is not recommended to increase the video preview window, which will cause the video stream to freeze; if the CPU has reached 80% and the video window does not meet the actual application, the system configuration needs to be improved.

1.2 System Installation

Step 1: Obtain the installation package.

Instruction:

Before installing the software, it is recommended to close the anti-virus software in the system to avoid failing the environment detection. If the antivirus software detects abnormality, you can also choose to ignore it.

After running the application, there will be a few seconds of detection process, please be patient.

Step 2: Right-click the installation package installer, choose to run as an administrator, and the environment detection tool will automatically perform system environment detection. If an abnormality is detected during the installation process, the interface will give a prompt. The user can refer to the prompt information to repair, and re-test after repairing until all the test items are passed before proceeding to the next Step.

Step 3: If the detection is normal, click **Continue**.

Step 4: Select "I agree to this agreement (A)" and click **Next**.

Step 5: After configuring the server port and other parameters, click **Next**.

Instruction:

The default port is 8098, and the Adms service port defaults to 8088.

If the port is occupied, please modify the port number manually. When modifying, try to avoid the occupied ports in the system, and can not overlap with the database port 5442, redis port 6390, and 21 and 80 ports.

Check "Add firewall exception to this port" to prevent Windows Firewall from blocking the program from running.

The https protocol is used by default.

Step 6: After setting the installation directory, click **Next**.

Instruction:

The default installation path is C:\Program Files\ZKBioCVSecurity. You can also click **Browse** to customize the installation path. Please follow the interface prompts to ensure that the selected installation path has enough disk space.

Step 7: After setting the backup file storage path, click **Next**.

Instruction:

The system scans the entire disk by default, locates the drive letter with the largest free space, and creates a new SecurityDBBack folder. You can also click **Browse** to customize the storage path of the backup file.

Step 8: Click "Install" to start installing the software.

Step 9: After the installation is complete, you will be prompted whether to restart the computer immediately (the default is "Yes"). Click **Finish** to restart the computer to complete the software installation.

Instruction:

After the software installation is complete, it will take a long time (about 2 minutes) for the service to start up. Please wait patiently for the service to start and then complete the operation.

Step 10: Enter the login page as shown in Figure 1-2, log in to the system.

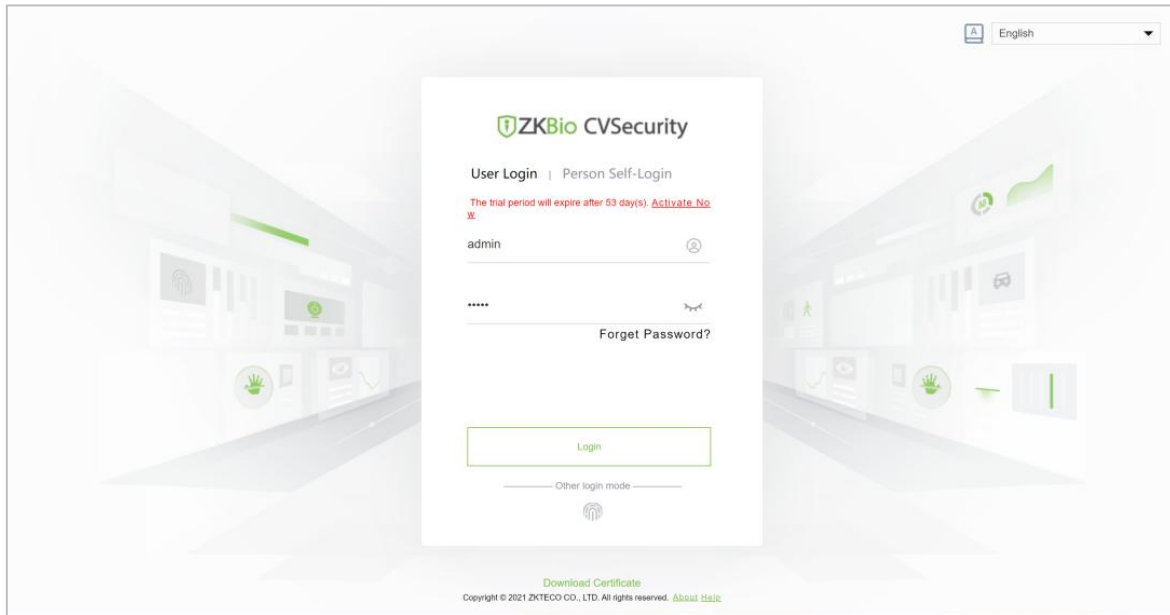
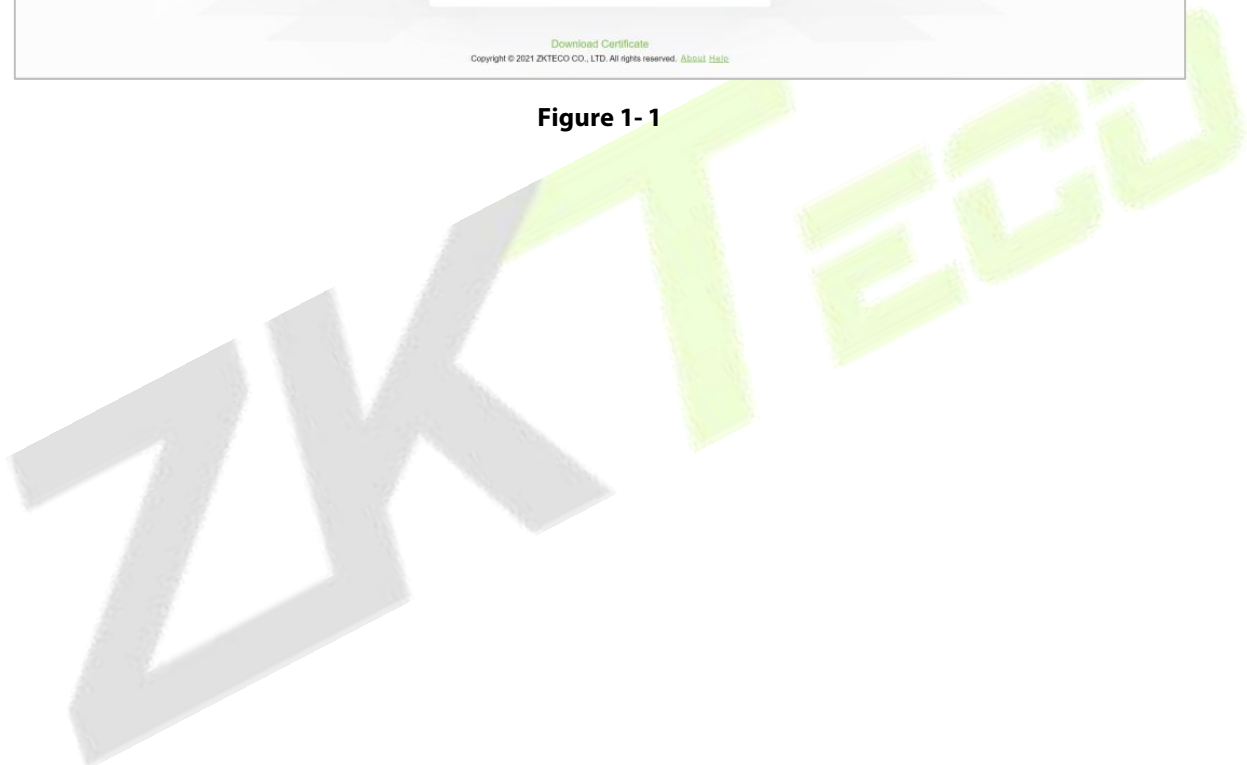

Figure 1- 1



2 Personnel

Before using the other functions, please configure the personnel system: Personnel and Card Management.

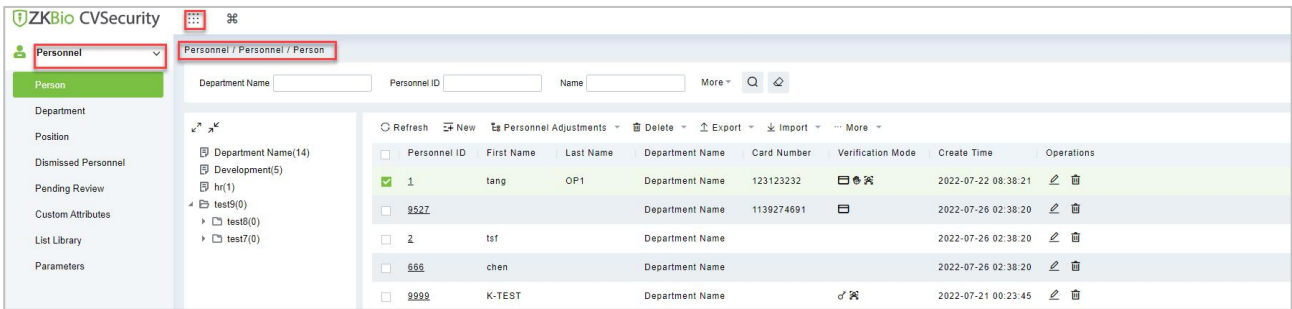

Figure 2- 1 Personnel

2.1 Personnel Management

Personnel Management includes these modules: **Person, Department, Position, Dismissed Personnel, Pending review, Custom Attributes, List Library, and Parameters.**

Operating Procedures:

This operation process is suitable for guiding users how to configure and manage the basic personnel organization after the system is installed.

The flow of personnel organization configuration is shown in Figure 2-2.

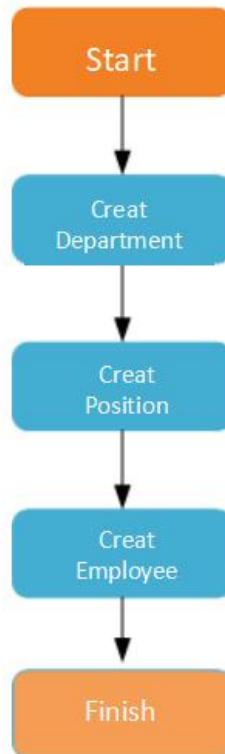

Figure 2- 2 Flowchart of Personnel Configuration

2.1.1 Person

When using this management program, the user shall register personnel in the system, or import personnel information from other software or documents into this system.

Main functions of Person include Refresh, Add (New), Personnel Adjustments, Delete, Export, Import, and more.

2.1.1.1 Add Personnel (New)

Click **Personnel > Personnel > New**.

The screenshot shows a 'New' personnel registration window. It features two columns of input fields. The left column contains: Personnel ID* (text box with '10000'), First Name, Gender (dropdown), Certificate Type (dropdown), Birthday, Hire Date, Device Verification Password, and Biometrics Type. The right column contains: Department* (dropdown with 'Department Name'), Last Name, Mobile Phone, Certificate Number, Email, Position Name (dropdown), and Card Number. There are checkboxes next to Mobile Phone and Email, and a camera icon next to Card Number. A profile picture placeholder is on the right with 'Browse' and 'Capture' buttons. Below the form is a 'Levels Settings' section with a tree view showing 'General' selected. To the right of this are settings for 'Superuser' (dropdown 'No'), 'Device Operation Role' (dropdown 'Ordinary User'), and checkboxes for 'Extend Passage', 'Disabled', and 'Set Valid Time'. At the bottom are 'Add', 'Select All', and 'Unselect All' buttons. The footer has 'Save and New', 'OK', and 'Cancel' buttons.

Figure 2- 3 Add Personnel New

Fields are as follows:

Notes:(Personnel ID)

When configuring a personnel number, check whether the current device supports the maximum length and whether letters can be used in personnel ID.

To edit the settings of the maximum number of characters of each personnel number and whether letters can also be used, please click **Personnel > Parameters**.

Parameter	Description
Personnel ID	An ID may consist of up to 9 characters, within the range of 1 to 79999999. It can be configured based on actual conditions. The Personnel No. contains only numbers by default but may also include letters.
Department	Select from the pull-down menu and click OK . If the department was not set previously, only one department named Company Name will appear.
First Name/Last Name	The maximum number of characters is 50.
Gender	Set the gender of personnel.
Mobile Phone	The max length is 20, and this is an optional field.
Certificate Type	There are four types of certificates: ID, Passport, Driver License and Others. Select one to upload.
Certificate Number	Enter certificate number
Birthday	Input employee's actual birthday.
Email	Set the available email address of the personnel. The max length is 30. Punctuations, namely, the " - ", " _ " and " . " are supported. If the Event Notification is checked, the Email is required.
Hire Date	It is the date on which the personnel are appointed. Click to select the date.
Position Name	Set a suitable name for the position. Any character, maximum combination of 100 characters. Position names should not be repeated.
Device Verification Password	Set password for personnel accounts. It can only contain up to 6-digits. If a password exceeds the specified length, the system will truncate it automatically. It cannot be the same with others password and the duress password.
Card Number	The max length is 10, and it should not be repeated.

Table 2- 1 Personnel ID

Biometrics Type:

This paper introduces the Steps of personnel biometric registration in ZKBioCVSecurity. The registered biometric data can be used for verification and identification of **Access Control**, attendance, and other equipment.

Biometric registration includes **fingerprint**, **finger vein**, and **palm registration**. Since the interfaces of fingerprint registration and finger vein registration are similar, fingerprint registration and palm print registration are used as examples to illustrate the operation process.

Description:

The server side of the box does not support external "palmprint meter, finger vein meter" to collect biometric templates, and the fingerprint reader is only supported by the "Live20R" model.

Preconditions:

On the computer terminal where the administrator registers the personnel information, connect the fingerprint reader device through the USB port.

Steps:

Step 1: In the **Personnel** module, choose **Personnel Management > Person**.

Step 2: Click **Add** with the mouse, and the interface for adding personnel will pop up.

Step 3: On the interface for adding personnel, click the "" button.

Step 4: (Optional) If the driver is not installed, click the icon to pop up the registration and driver download box, download the driver, and complete the installation.

Step 5: After the driver is installed, fingerprint registration can be performed, as shown in Figure 2-4.

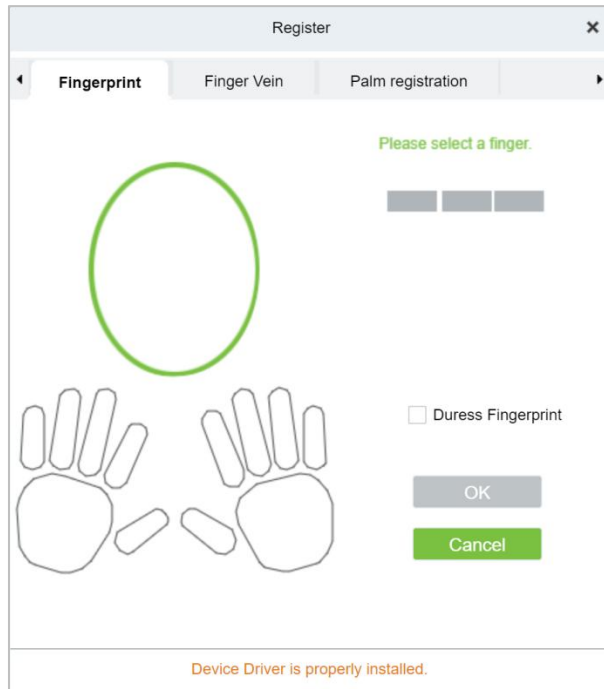

Figure 2- 4 Biometric Type

Step 6: Select the fingers respectively, press the fingerprint on the connected fingerprint reader three times in a row, and the system prompts the fingerprint to be registered successfully.

Step 7: Click **OK** to save and close the fingerprint registration interface.

Personal Photo:

The picture preview function is provided, supporting common picture formats, such as **jpg, jpeg, bmp, png, gif** etc. The best size is 120×140 pixels.

Browse: Click **Browse** to select a local photo to upload.

Capture: Taking photo by camera is allowed when the server is connected with a camera.

Access Control:

Click **Access Control** parameter for the personnel.

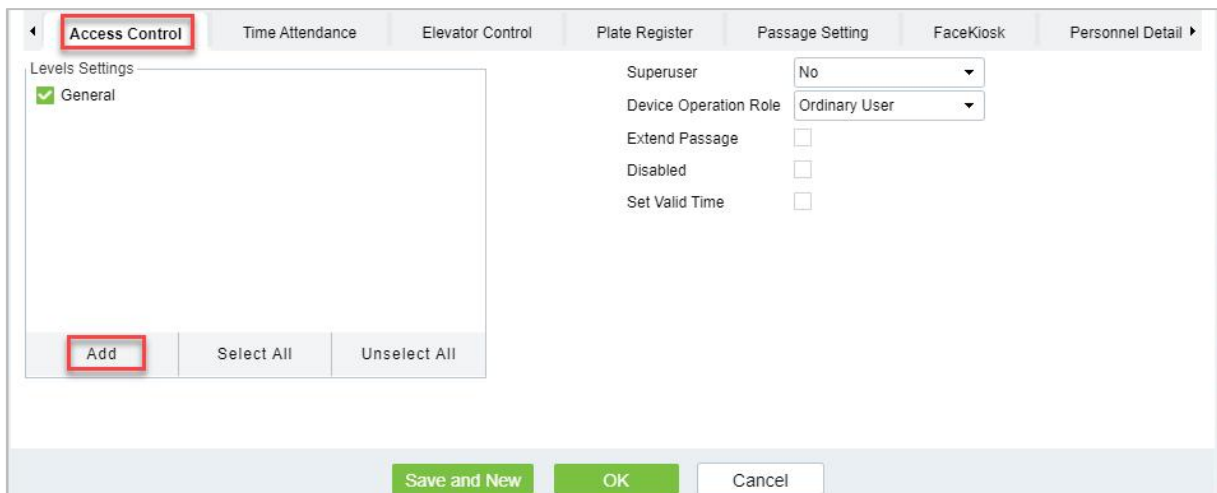

Figure 2- 5 Access Control

Fields are as follows:

Parameter	Description
Level settings	Click Add , then set passage rules of special positions in different time zones.
Superuser	In access controller operation, a super user is not restricted by the regulations on time zones, anti-passback and interlock and has extremely high door-opening priority.
Device Operation Role	Select administrator to get its levels.
Extend Passage	Extend the waiting time for the personnel through the access points. Suitable for physically challenged or people with other disabilities.
Disabled	Temporarily disable the personnel's access level.
Set Valid Time	Set Temporary access level. Doors can be set to open only within certain time periods. If it is not checked, the time to open the door is always active.

Table 2- 2 Access Control

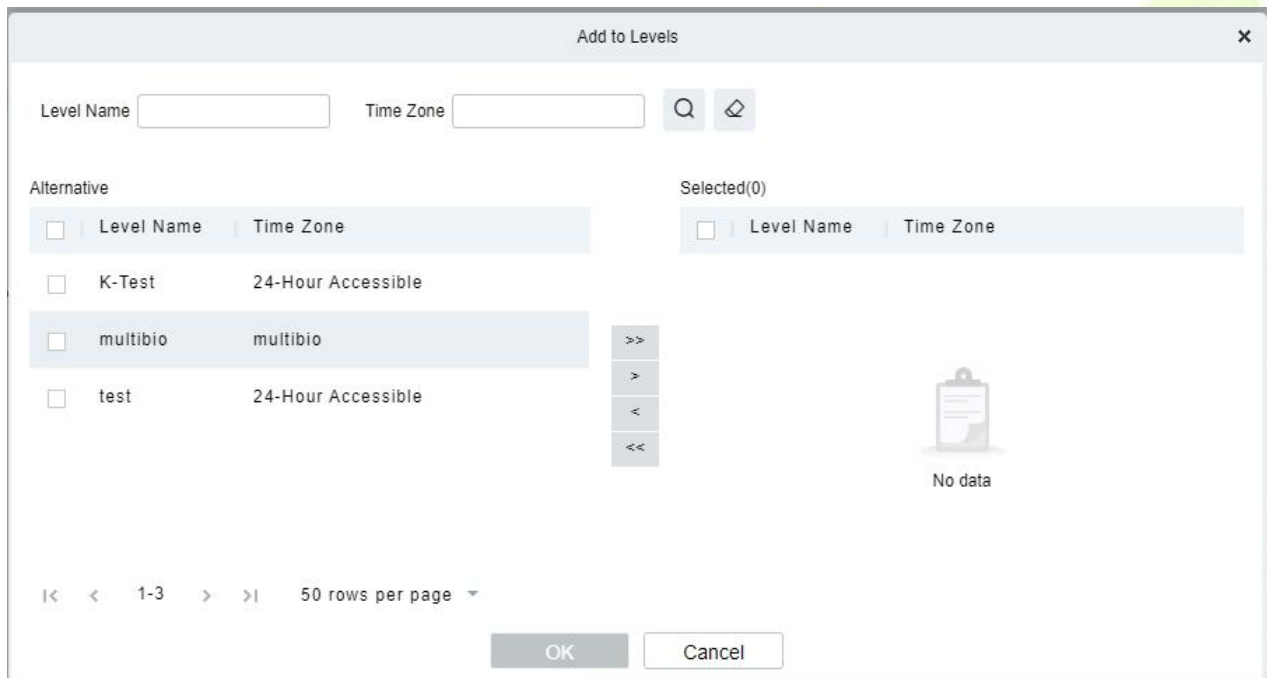

Figure 2- 6 Level Settings

Note:

1. The system will automatically search for the relevant numbers in the departure library during verification.
2. The Personnel Information List, by default, is displayed as a table. If Graphic Display is selected, photos and numbers will be shown. Put the cursor on a photo to view details about the personnel.
3. Not all devices support the "Disabled" function. When a user adds a device, the system will notify the user whether the current device supports this function. If the user needs to use this function, please upgrade the device.
4. Not all the devices support the "Set Valid Time" function of setting the hour, minute, and second. Some devices only allow users to set the year, month, and day of the local time. When a user adds a device, the system will notify the user whether the current device support this function. If the user needs to use this function, please upgrade the device.

Time Attendance:

Set the **Time Attendance** parameter for the personnel.

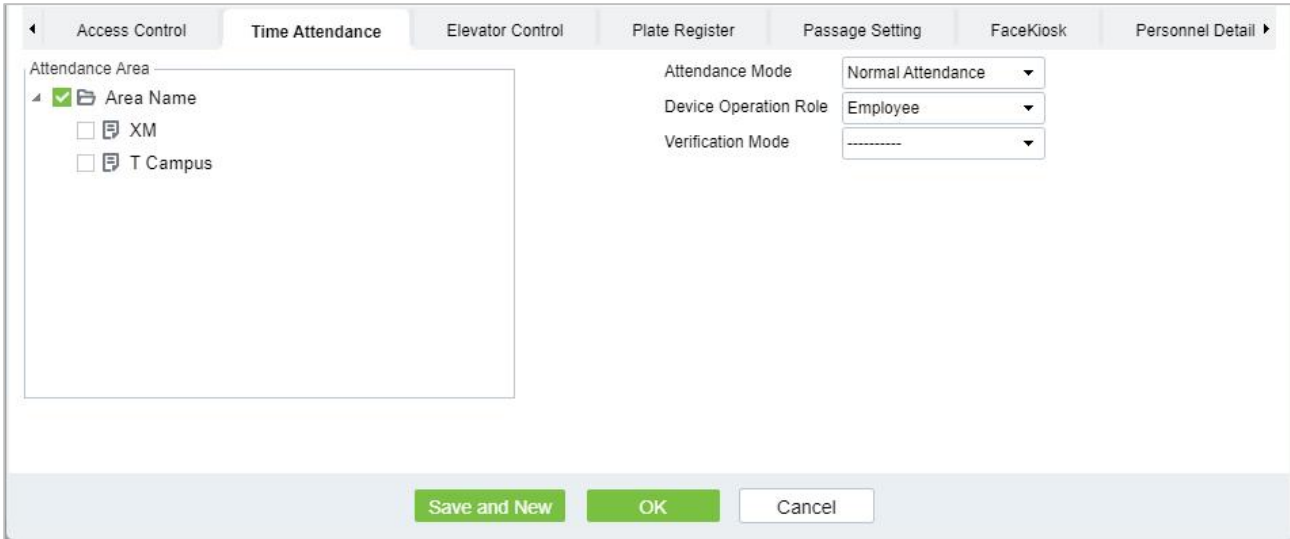

Figure 2- 7 Time Attendance

Fields are as follows:

Parameter	Description
Attendance Mode	You can set the staff attendance area as Normal Attendance and No Punch Required .
Device Operation Role	It will set the authority for operating the device and send it to the corresponding device such as, Employee, Enroller, Administrator, and Superuser
Verification Mode	You can set verification mode as following options: Automatic Recognition, Fingerprint, PIN, Password, Card, Fingerprint/ Password, Fingerprint/Card, PIN+Fingerprint, Fingerprint+Password etc.

Table 2-3 Time Attendance

Elevator Control:

Click **Elevator Control**, set the Elevator Control parameter for the personnel.

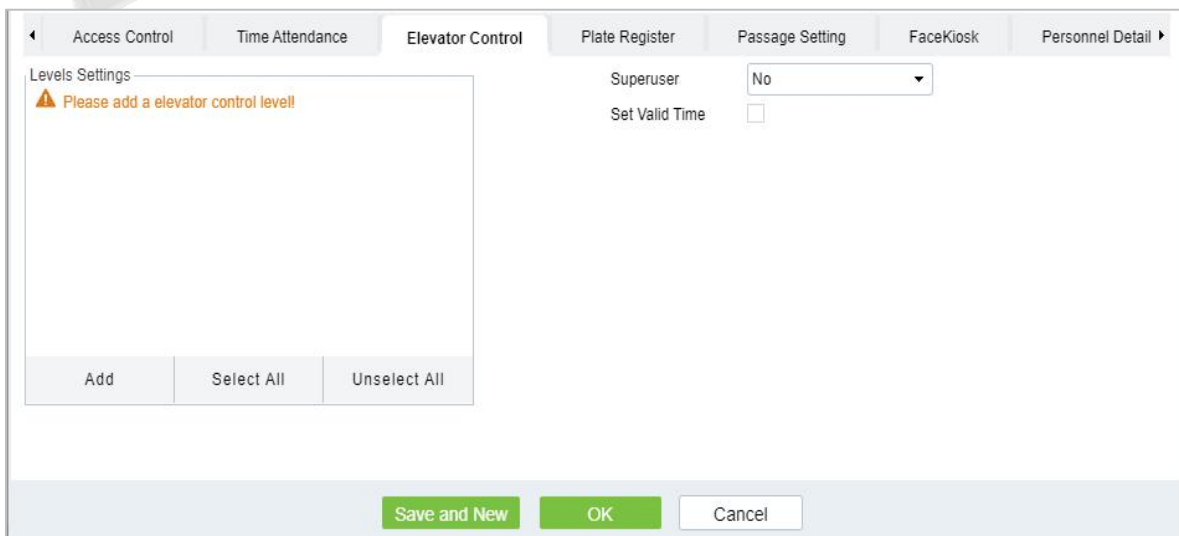

Figure 2- 8 Elevator Control

Fields are as follows:

Parameter	Description
Superuser	In elevator controller operation, a super user is not restricted by the regulations on time zones, holidays and has extremely high door-opening priority.
Set Valid Times	Set Temporary elevator level. Floor buttons can be set to be pressed only within the time periods. If it is not checked, the time to press the floor button is always active.

Table 2- 3 Elevator Control

Note: The Elevator level must be set in advance.

Plate Register:

Click **Plate Register**, set the plate control parameter for the personnel.

Figure 2- 9 Plate Register

Fields are as follows:

Parameter	Description
License Plate	The user needs to register the license plate.
Parking Space Number	Parking space number corresponding to the vehicle.

Table 2- 4 Plate Register

Note: Each personnel may register a maximum of 6 license plates.

Passage Setting:

Click **Passage Setting**, set the Passage Setting parameter for the personnel.

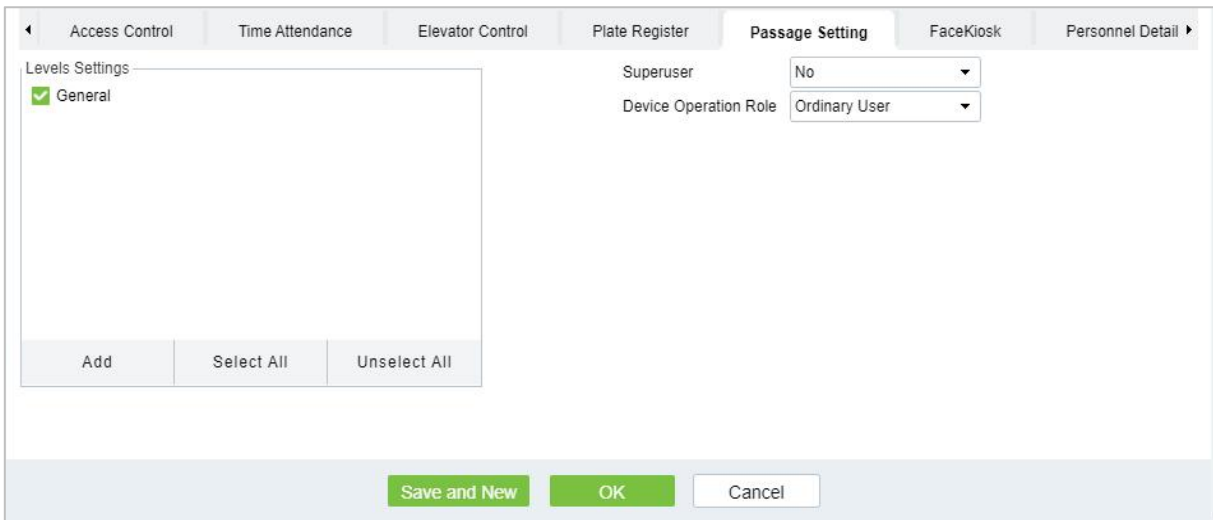

Figure 2- 10 Passage Setting

Fields are as follows:

Parameter	Description
Superuser	Set Superuser as Yes or No according to requirement.
Device Operation Role	It will set the authority for operating the device and send it to the corresponding device such as, Ordinary User, Administrator, and Enroller.

Table 2- 5 Passage Setting

Facekiosk:

Click **Facekiosk**, set the Facekiosk parameter for the personnel.

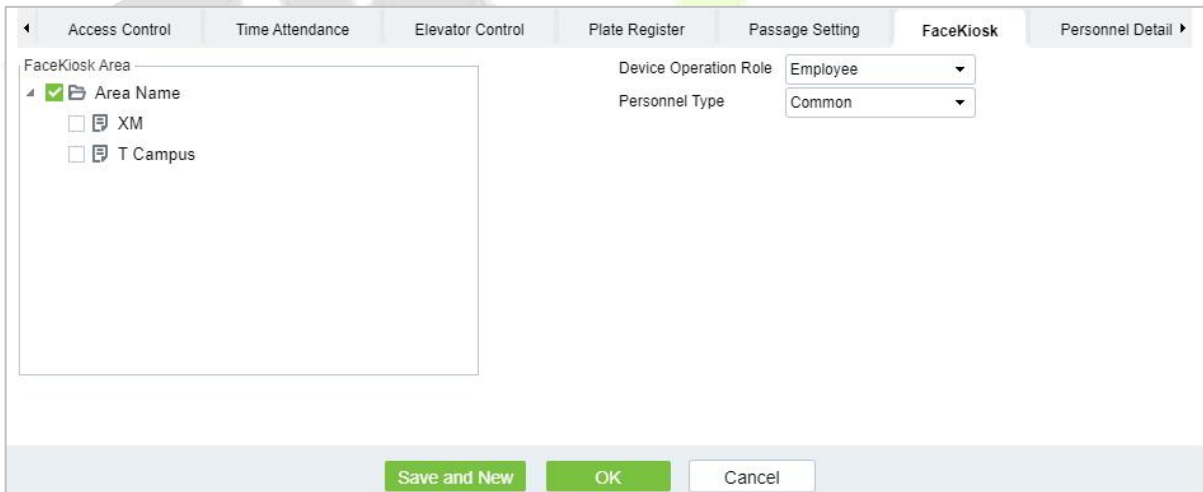

Figure 2- 11 Facekiosk

Fields are as follows:

Parameter	Description
Device Operation Role	It will set the authority for operating the device and send it to the corresponding device such as, employee and Superuser.
Personnel Type	Select type of personnel such as Common, VIP, and Blocklist.

Table 2- 6 Facekiosk

Personnel Details:

Click **Personnel Details**, to set the Personnel detail parameter for the personnel.

Figure 2- 12 Personnel Details

After entering the information, click **OK** to save and exit, the person details will be displayed in the added list.

2.1.1.2 Personnel Adjustments

Click **Personnel > Person > Personnel Adjustment**.

Adjust Department:

Click **Personnel > Person > Personnel Adjustment**, then select **Adjust Department**.

Figure 2- 13 Adjust Department

Fields are as follows:

Parameter	Description
New Department	Select new department from list.
Transfer Reason	Mention the reason for transfer.

Table 2- 7 Adjust Department

Change Position:

Click **Personnel > Person > Personnel Adjustment**, then select **Change Position**.

Figure 2- 14 Change Position

Parameter	Description
New Position	Select new Position from list.
Transfer Reason	Mention the reason for transfer.

Table 2- 8 Change Position

Dismissal:

Click **Personnel > Person > Personnel Adjustment**, then select **Dismissal**.

Figure 2- 15 Dismissal

Fields are as follows:

Parameter	Description
Dismissal Date	Select date.
Dismissal Type	Select the type of dismissal from follows, Voluntary Redundancy, Transfer, Dismissed, Resignation.
Dismissal Reason	Mention the reason for Dismissal.

Table 2- 9 Dismissal

2.1.1.3 Delete

Click **Personnel > Person**, then select **Delete**.

Delete Personnel:

Click **Personnel > Person > Delete**, then select **Delete Personnel**.

Delete Biometric Data:

Click **Personnel > Person > Delete**, then select **Delete Biometric Data**.

2.1.1.4 Export

Click **Personnel > Person**, then select **Export**.

Export Personnel:

Click **Personnel > Person > Export**, then select **Export Personnel**.

Personnel’s basic information is all checked (selected), check custom attributes as required.

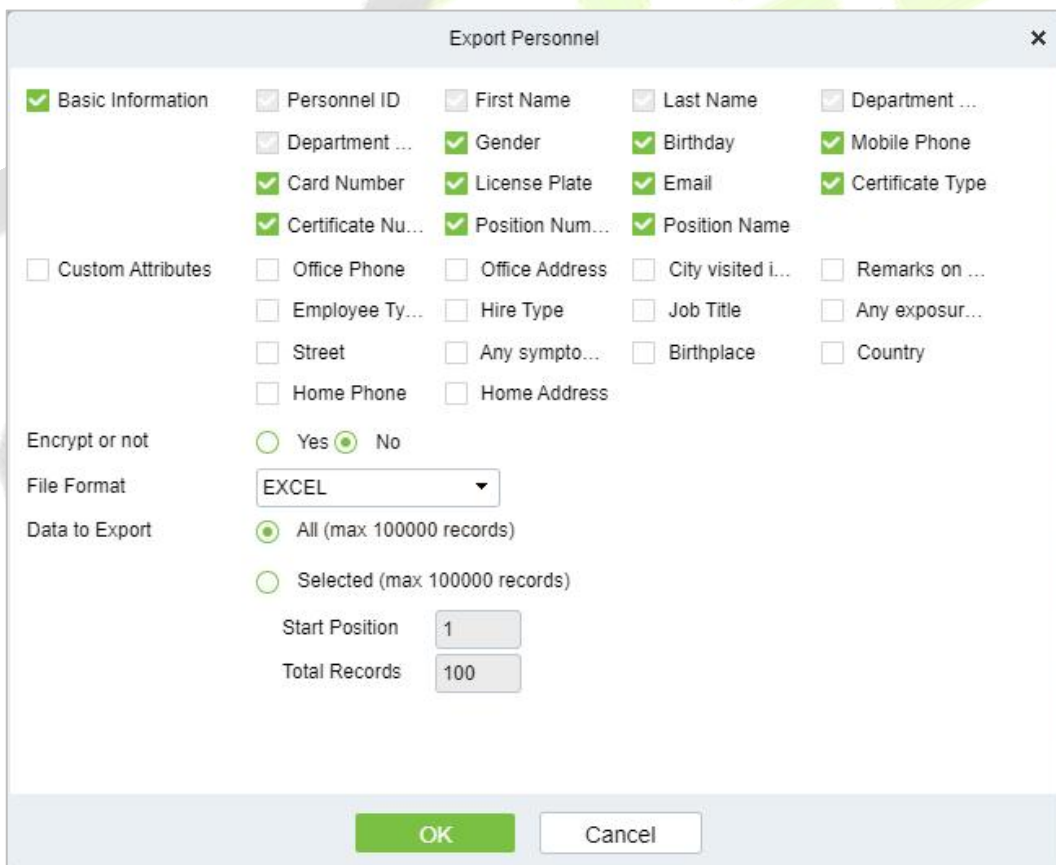

Figure 2- 16 Export Personnel

Personnel ID	First Name	Last Name	Department Number	Department Name	Gender	BirthDay	Mobile Phone	Card Number	Lice
1	ju		1	Department Name					
9999	K-TEST		1	Department Name					
12135			1	Department Name					
12134	name1		3	hr	Male				
1114	Md. Jalal		2	Development	Male			123456	
1119	multibio		1	Department Name					
5	YYYY		1	Department Name					
2222	ygv		1	Department Name					
555	fc		1	Department Name					
4	W9		1	Department Name					
3			1	Department Name					
1118			1	Department Name					
1116			1	Department Name					
1115	Zorro		2	Development					
1113	Abdulla		2	Development	Male			654321	
1111	Esha Test		2	Development	Female			145632	
1112	Anwar Hossain Abid		2	Development	Male			654987	

Figure 2- 17 Export Personnel

Export Biometric Template:

Click **Personnel > Person > Export**, then select **Export Biometric Template**.

Export Biometric Template ✕

Encrypt or not Yes No

File Format EXCEL ▾

Data to Export All (max 100000 records)

OK
Cancel

Figure 2- 18 Export Biometric Template

Personnel Biometric Template											
Personnel ID	First Name	Last Name	Biometric Template Validity	Biometric Template Type Number	Biometric Template Type	Biometric Template Version	Biometric Template	Biometric Template No.	Biometric Template Index	Duress	
1	tang	OP1	Effective	8	Palm Vein	12	aPUBUEQAHYUJIAAWAAWQeAt+TUIDKJ0bXAVICEEhJwmjUeEJLWLtA CEWfnTqHe7vKH9lFTUMamv8Cfr7RHhHccDpmp+HdQYHMEUjgz1tOc EBITrDhng5wteDnB4FuSrfqZA/eKnqSorsijSpidVyfr3MTY3jhwW9z tbTfoDRUI8onqj04/OY4P505P513qk1tpJZYfWlpbwjHInN9ZEdAjBmZ n9KD2oOINNONISXJz+Lnv+nASS0gbC35/UUI6TuzBmS2eYqLRQYWRJ InBKyyZZaKEBUJZQ6CoCoMaKJPCs3KVBCPreq3a6vCH+LPDRckis0yLq 7BLKnOMApWh9IRMBHueRvQtwrtRgfudLTTdA7Xsq9Ux7TXN7fdGQ+ buOBTSLR6errWIBil/aVwTbX8fb3zJTGmvoJzTpDBwIDKMo6xQzXochL Kg4PPN8u0QtNaQffhobyfI3EYshRI1ghSYn5OVDP6jTH1gzxlz/16u/D ch+HSCQj4/yMRSIExb1Fj+OePlXmbdwBjOxE/SJFZxwNfD1YSiyFNKEG Jj/ev/6lqX+mtdgHG5v6X7J5G5d7vp0+Xp75VDJ7JfHc06JBVaHGRQvAJ9 8B0q/EZKTARBAHp9YMV73nZ6fmmwOZqNVIWLLraqmmCSblZjgXT3s 7a3lPaG/LuFJRhH5Ld6AvqmcD86fzL+s7Pnr+7TcF731qrtrbTBO3QhUt 05XDgubnYDJaWOXpQqGmvLzFG5GBPHlaPMokP7/IYq5MAybkAuMc AoL4uXinLPhR4QbRYXixeDnN7lJrWlSjYjyIoAvRsaYgr54vovyoQf Nv70uTo7raD5rFOZy457xUZH2YTHaFuQ54o7UVJ4pBaMF/A626/XF 5FV15eJGPyVYCVbGprQJUSHLUVSUnZ3dDdIXWIXUGHtkDxjvPmd 9mv5L5no6P+v/rD9Vbp3Gu/pqblUb7Lrg9e+1WYqanoTKIGrXfYRkrzK zryldh6llZ14xb6/m1ZrcibZUcEscrLV9NXbBJJxdYrdbX68dfb41zdD86 eLjV/ghV9kR4UTw5e7vYbwxw8cJ31rE+fr7bxR93Deek6z3QYHmu4H bAuQarTMBITjnlcB7kOb7bP84fMk4bRCLZBYCvDiorIEMVGTjpMYSZ EY3cPYNjzxR8agckJDLy32wGFou36ak5PWVLT4mxJtZCqNlPbrd5+rI h9eUgyG2Znc3FGHxyeVR+CXzD1ZFRWhbWRgBX5/87v5SGtdkbiUS YqL/6dFqeDjgbyltZaXqzDP61JntC+gakJNcpk8p1XgwbSja6vRQ1wI MqnxrRmbq7Lgr2MN+4e4T5MbH2l7TLMOxTWod8NLTx7rPmN4hWX xb/t7u0+20fnt4f8szurrXNJPKN5+Gwaivb3sXdfYrV1qEm0hgDjdaH1 nF1EWWh+yg4PmTKb8ApwHSQIZhobBy45fDAeKRAKXSYnMwpdCDUw Q8nCTH8k718M4BQCuDT4fMwN7ho6Zy56Upl05eD9u5UUR3a	0	1	No	

Figure 2- 19 Export Biometric Template.

Export Personnel Photo:

Click **Personnel > Person > Export**, then select **Export Personnel Photo**.

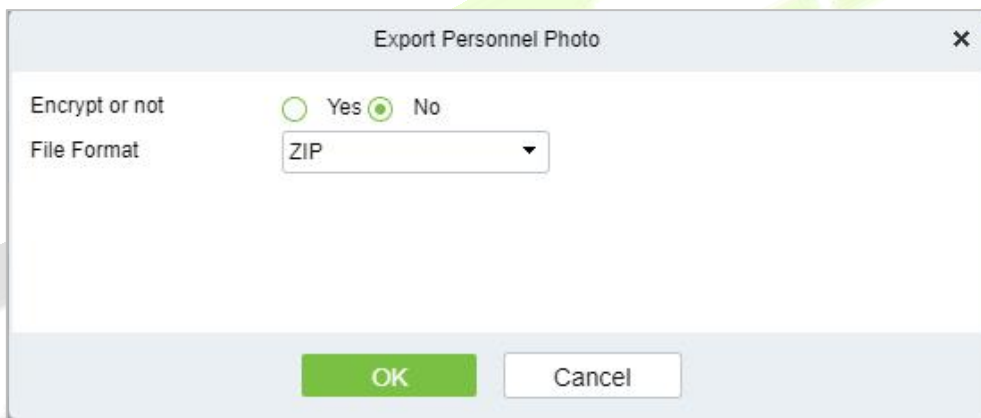

Figure 2- 20 Export Personnel Photo

2.1.1.5 Import

Introduce the configuration Steps of manually importing personnel in batches in ZKBioCVSecurity.

It is suitable for scenarios where a large number of personnel information is added. Compared with the manual registration method of individual personnel, the batch import and addition method is faster.

Before adding departments in batches, you need to fill in the template file as required. After filling out the template file, you can import and add departments in batches in the "Department" interface.

Instruction:

1. The import and addition of personnel includes importing personnel information, personnel biometrictemplate data (optional), and personnel photos (optional), which need to be imported separately.
2. Importing is to pay attention to the uniqueness of the personnel number. When the personnel number is repeated, the result of import and addition will fail.

● **Import Personnel Information**

Before adding people in batches, you need to obtain or fill in a template file as required. After filling in

the template file, you can import and add people in batches on the Personnel Management > Personnel interface.

Steps:

Step 1: In the **Personnel** module, choose "**Personnel Management > Personnel**".

Step 2: On the personnel interface, select and click the "**Import > Download Personnel Import Template**" button, select the parameters to be filled in, and download the template "personnel information template.xls" locally. The parameter selection is shown in Figure 2-21.

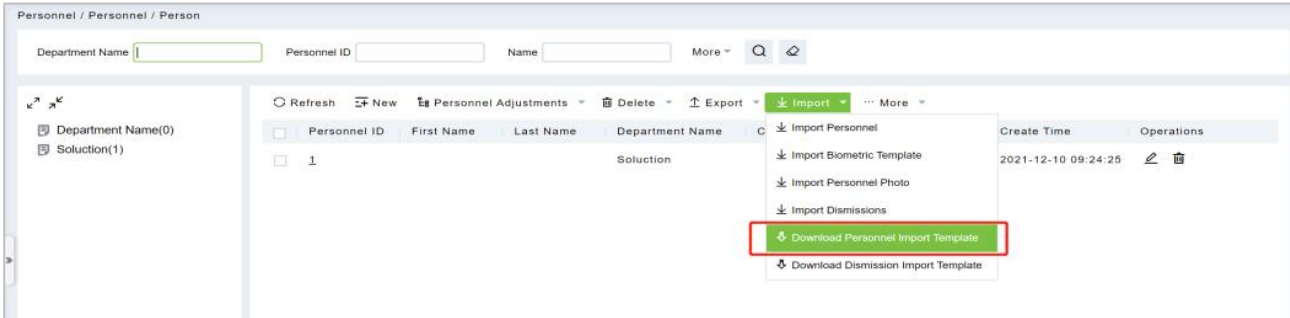

Figure 2- 21 Import Personnel Information Template

Step 3: Open the exported template file "Personnel Information Template.xls" for adding personnel information.

Step 4: In the personnel interface, select and click the "**Import > Import Personnel Information**" button; in the **Import Personnel** Interface, click the **Browse** button to import the batch import template into the system, as shown in Figure 2-22.

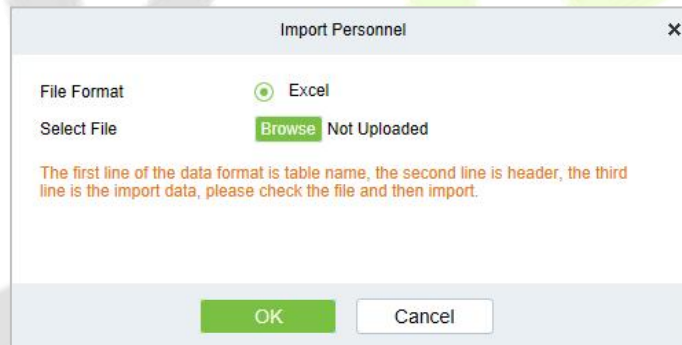

Figure 2- 22 Import Personnel

Step 5: Click **OK**, and the interface displays the result of personnel import and addition.

Step 6: Click **Close** to complete the import and addition of personnel information.

● **Import Biometric Template**

Preconditions:

- 1. The system needs to have the basic information files of the personnel in order to support the import of biometric template data.
- 2. The biometric template data of the current system personnel has been obtained.

Steps:

Step 1: In the **Personnel** module, choose "**Personnel Management > Personnel**".

Step 2: On the personnel interface, select and click the "**Import > Import Biometric Template Data**" button; in the pop-up import personnel biometric template data interface, click the **Browse** button to import personnel biometric template data into the system in batches, as shown in Figure 2-23 is shown.

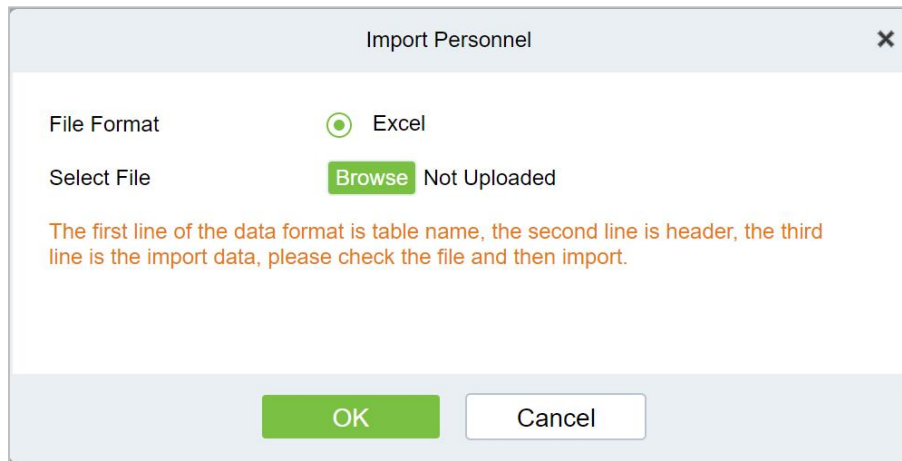

Figure 2- 23 Importing Personnel Biometric Template Data

Step 3: Click **OK**, the interface displays the import and addition results.

Step 4: Click **Close** to complete the import of personnel biometric template data.

● Import Personnel Photos

Preconditions:

1. The system needs to have the basic information files of the personnel in order to support the import of personnel photos.
2. The personnel photos of the current system personnel have been obtained and correctly named according to the personnel number.
3. The photo requirements for personnel are as follows:

Image Format: support .jpg, .png format.

Image Size: The recommended image size is 35KB~200KB, and the maximum size of a single image is 5MB.

Image Quality: Faces in images are clear and not blurred by lens defocus or face motion. The minimum image depth is an 8-bit grayscale image.

Pixels: The recommended value of face pixels is 80*80~200*200, and the distance between the eyes should be greater than or equal to 60 pixels, preferably greater than or equal to 90 pixels.

Brightness and Contrast: The ambient illumination is not less than 300Lux, the image brightness is uniform, the contrast is moderate, and the face has no invisible, no backlight, no reflection, no overexposure, no underexposure and no yin and yang faces.

Attitude: The portrait is upright, looking straight ahead, the horizontal rotation angle of the face should be within $\pm 10^\circ$, the elevation angle should be within $\pm 10^\circ$, and the tilt angle should be within $\pm 10^\circ$.

Blocking: Eyebrows, eyes, mouth, nose and facial contours should not be blocked by bangs, masks, accessories, glasses, etc. The lenses of glasses should be colorless and non-reflective, and the frames of glasses should not be too thick to block human eyes.

Face Area: The face is complete, the outline and facial features are clear, and there is no heavy makeup. The face area of the image should not be processed by PS.

Expression: Natural expression, neutral or smiling (no missing teeth), eyes open naturally, mouth closed naturally, no obvious expressions such as laughter or frown.

Steps:

Step 1: In the **Personnel** module, choose "**Personnel Management > Personnel**".

Step 2: On the Personnel interface, select and click the "Import > Import Personnel Photo" button, as shown in Figure 2-24.

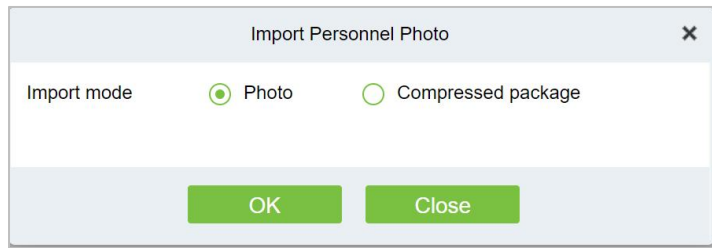

Figure 2- 24 Import Personnel Photos

Step 3: Optional: upload photos and compressed packages.

Step 4: After selecting the photo method, click **OK** to enter the interface for importing personnel photos, select the photo and click **Start Uploading**.

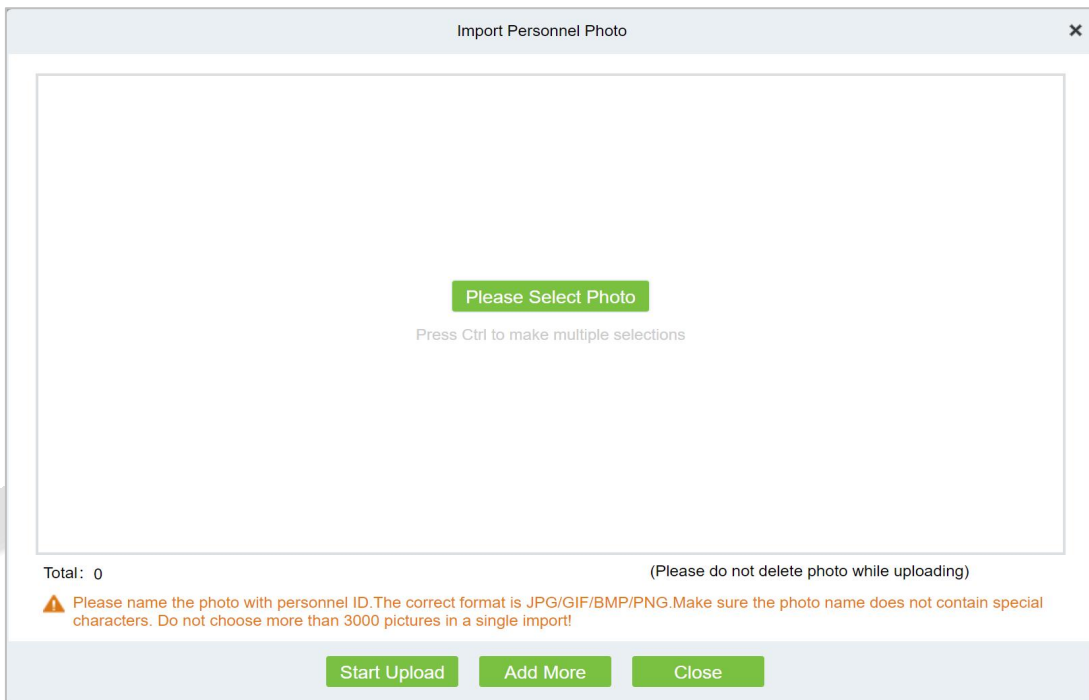

Figure 2- 25 Photos - Importing Personnel Photos

Step 5: After selecting the compression package method, click **OK** to enter the interface of importing personnel photos, click **Browse** to select the file and then click "**Start Uploading**".

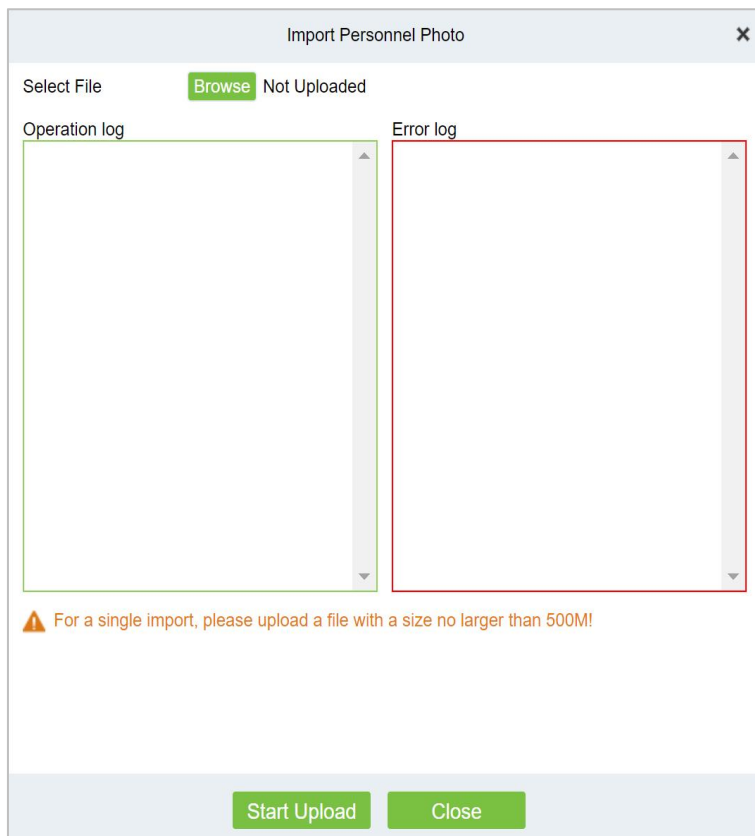

Figure 2- 26 Compressed Package - Importing Personnel Photos

Step 6: After the upload is complete, the interface displays the results of the imported personnel photos.

Step 7: Click **Close** to complete the import and addition of personnel photos.

2.1.1.6 More

- **Statistics**

Click **Personnel > Person > More**, then select **Statistics**.

Statistical Type	Current Total
Male	4
Female	1
Person	22
Fingerprint	0
Near Infrared Face	0
Finger Vein	0
Palm Vein	V12.0 1
Visible Face	V58.12 1
Card	6
Face Picture	3

Figure 2- 27 Statistics

View the number of Person, Male, Female, and the number of Fingerprints, Near Infrared Face, Finger

Vein, Palm Vein, Visible Face, Card, and Face Picture.

- **Reset Self Login Password**

Click **Personnel > Person > More**, then select **Reset Self Login Password**.

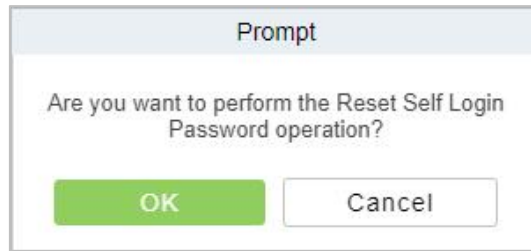

Figure 2- 28 Statistics

2.1.2 Department

Click **Personnel**, then select **Department**.

Before managing company personnel, it is required to set a departmental organization chart of the company. Upon the first use of the system, by default it has a primary department named General and numbered 1. This department can be modified but can't be deleted.

Main functions of Department Management include **Add (New)**, **Delete**, **Export** and **Import Department**.

2.1.2.1 Add a Department (New)

Introduce the configuration Steps for manually adding a single department in ZKBioCVSecurity.

It is suitable for scenarios where a small number of departmental organizations are added. After most departmental organizations have been created, individual departments can be added individually.

Steps:

Step 1: In the **Personnel** module, choose "**Personnel Management > Department**".

Step 2: Click **Add** with the mouse, and the interface for adding a department will pop up.

Step 3: In the interface of adding a department, fill in the corresponding parameters according to the adding requirements, as shown in Figure2-29. Please refer to Table 2-10 for the description of parameter filling.

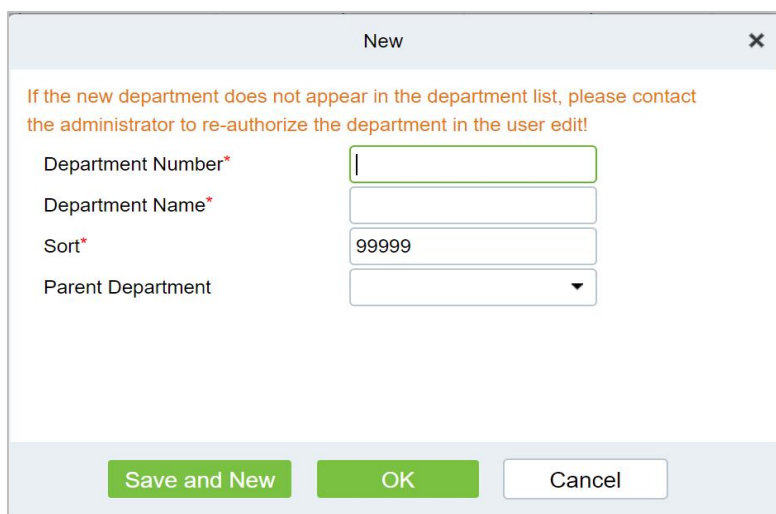

Figure 2- 29 Add Department (New)

Parameter	Instructions
Department Number	Customize the department number, support letters and numbers.
Department name	Customize the department name.
Sort	Fill in the number of the superior department.
Parent Department	The department name corresponding to the superior department number.

Table 2- 10 Add Department

2.1.2.2 Delete

Click **Personnel > Department**, then select **Delete**.

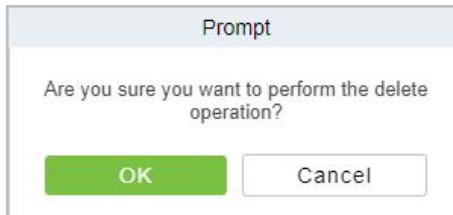

Figure 2- 30 Delete Department

2.1.2.3 Export

Click **Personnel > Department**, then select **Export**.

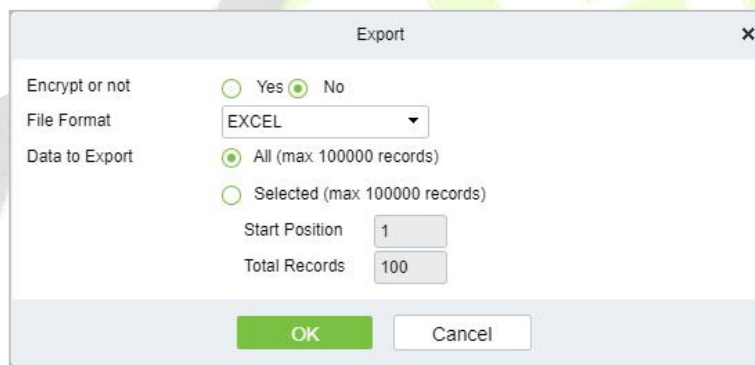

Figure 2- 31 Export Department

2.1.2.4 Import

Import:

Click **Personnel > Department > Import**, then select **Import**.

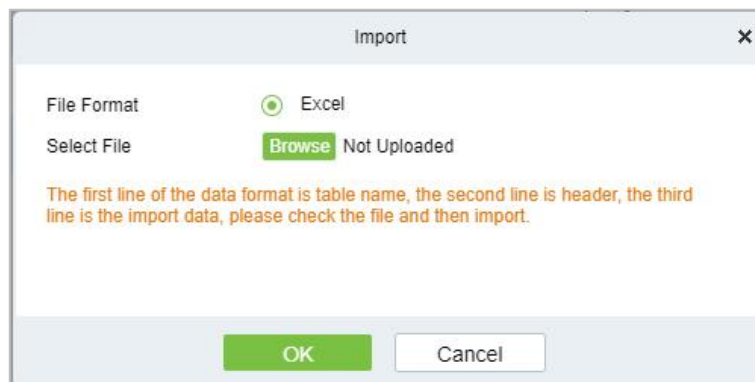

Figure 2- 32 Import Department.

Download Import Template Department:

Click **Personnel > Department > Import**, then select **Download Import Template Department**.

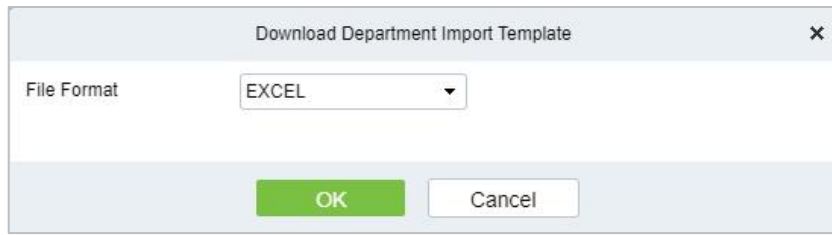

Figure 2- 33 Download Import Template Department

2.1.3 Position

Introduces the configuration Steps of manually adding a job in ZKBioCVSecurity, and adding a job is used to define the job information of a person.

Click **Personnel**, then select **Position**.

2.1.3.1 Add Position

Steps:

Step 1: In the **Personnel > Personnel Management > Position**.

Step 2: Click **New (Add Position)**, and the new job interface will pop up.

Step 3: On the new job interface, fill in the corresponding parameters according to the adding requirements, as shown in Figure2-34; please refer to Table 2-11 for parameter filling instructions.

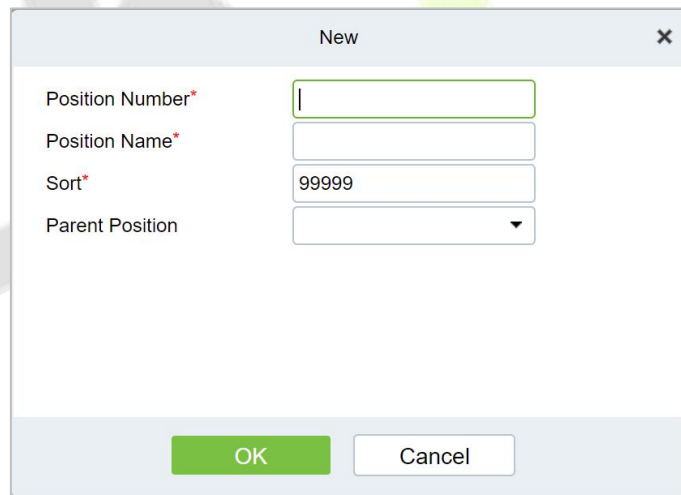

Figure 2- 34 Add Position (New)

Parameter	Instructions
Job number	Customize the job number for easy memory.
Job Title	Customize job title.
Sort	Sort job listings, only numbers are supported.
Parent position	Select the corresponding parent position from the drop-down radio box. If you need to cancel, click Selected again.

Table 2- 11 Adding New Position

2.1.3.2 Delete

Click **Personnel > Position**, then click **Delete**.

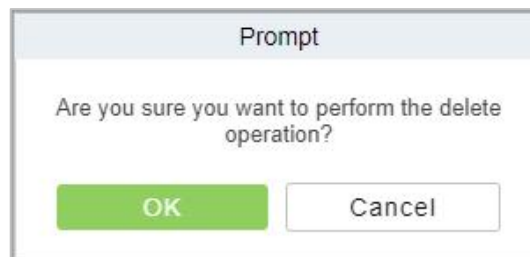

Figure 2- 35 Delete Position

2.1.3.3 Export

Step 1: Click Personnel > Position, then select Export.

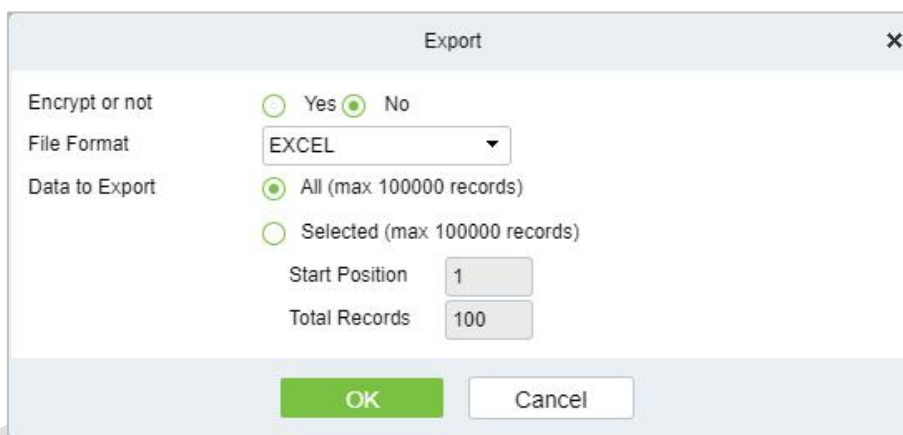

Figure 2- 36 Export Position

Step 2: Click **OK** to save to exit.

2.1.3.4 Import

Step 1: Click Personnel > Position > Import, then select Import.

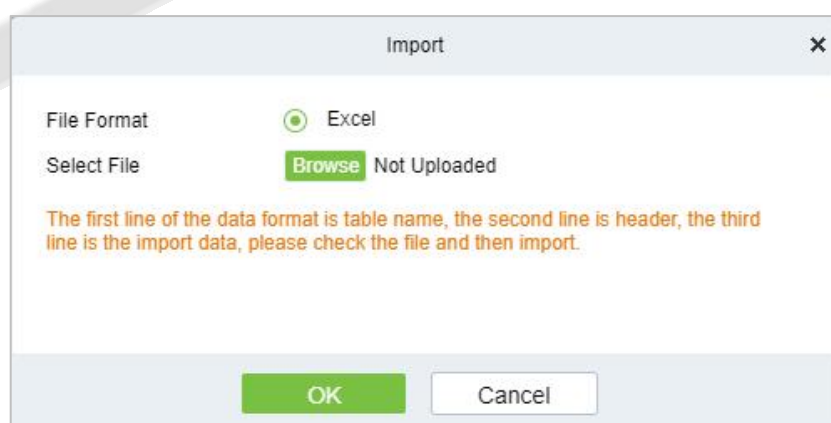

Figure 2- 37 Import Position.

Step 2: Click **OK** to save and exit.

2.1.4 Dismissed Personnel

This parameter will display the personnel who are not working in company anymore. Once the person is dismissed, it will be listed.

Click **Personnel**, then select **Dismissed Personnel**.

2.1.4.1 Delete

Step 1: Click Personnel > Dismissed Personnel, then select Delete.

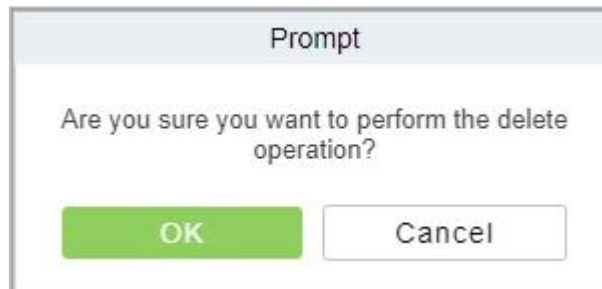

Figure 2- 38 Delete

Step 2: Click **OK** to save and exit.

2.1.4.2 Export

Step 1: Click Personnel > Dismissed Personnel, then select Export.

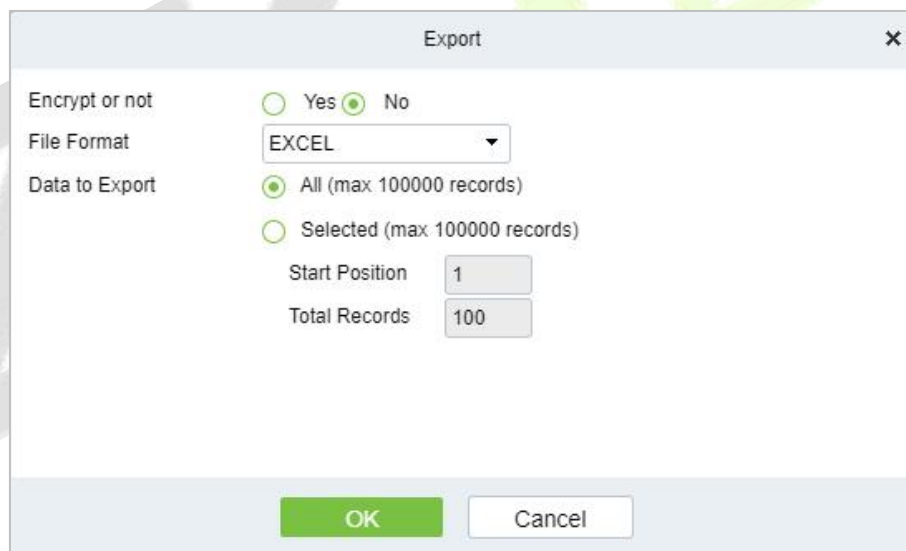

Figure 2- 39 Export

Step 2: Click **OK** to save and exit.

2.1.5 Pending Review

2.1.5.1 Delete

Step 1: Click Personnel > Pending Review, then select Delete.

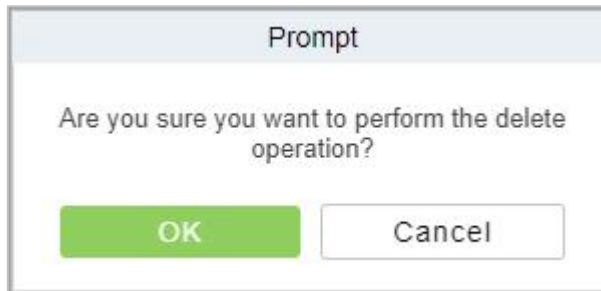

Figure 2- 40 Delete Pending Review

Step 2: Click **OK** to save and exit.

2.1.6 Custom Attributes

Some personal attributes can be customized or deleted to meet different customers' requirements. When the system is used for the first time, the system will initialize some personal attributes by default. Customized personal attributes can be set for different projects according to requirements.

Click **Personnel**, then select **Custom Attributes**.

2.1.6.1 Add Custom Attributes (New)

Step 1: Click **Personnel > Custom Attributes**, then select **New** (Custom Attributes).

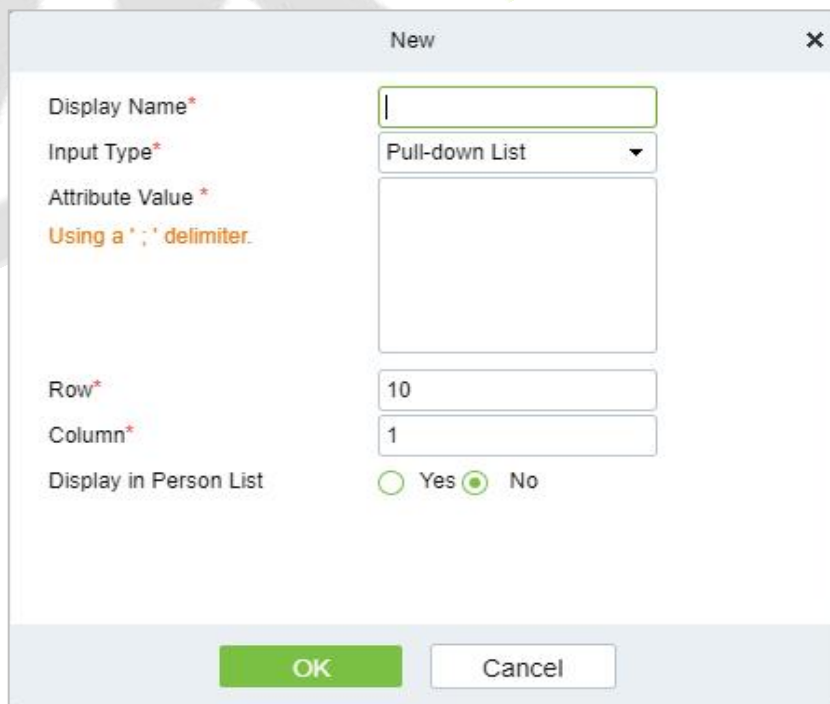

Figure 2- 41 Add Customer Attribute (New)

Fields are as follows:

Parameter	Description
Display Name	Must be filled and should not be repeated. Max length is 30.
Input Type	Select the display type from "Pull-down List"," Multiple Choice", "Single Choice" and "Text".
Attribute Value	Suitable for lists displaying as "Pull-down List","Multiple Choice" and "Single Choice" lists. Use a ";" to distinguish the multiple values. If the input type is "Text", the attribute value is not suitable.
Row/Column	The column and row of a field are used together to control the display position of the field. Numerals are supported. The column number cannot exceed 99, and the row number can only be 1 or 2. The combination of the column and row must not be duplicated. As shown in the following figure, Employee Type, is in the first column and first row, and Hire Type is in the first column and second row.

Table 2- 12 Add Customer Attribute (New)

Step 2: Click **OK** to save and exit.

2.1.6.2 Delete

Step 1: Click Personnel > Custom Attributes, then select Delete.

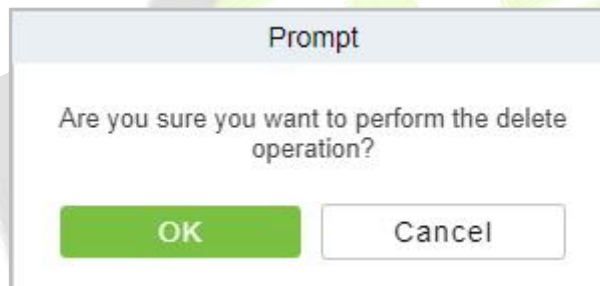

Figure 2- 42 Delete Custom attributes

Step 2: Click **OK** to save and exit.

2.1.7 List Library

2.1.7.1 Add a List Library (New)

Step 1: Click **Personnel > List Library**, then select **New** (List Library).

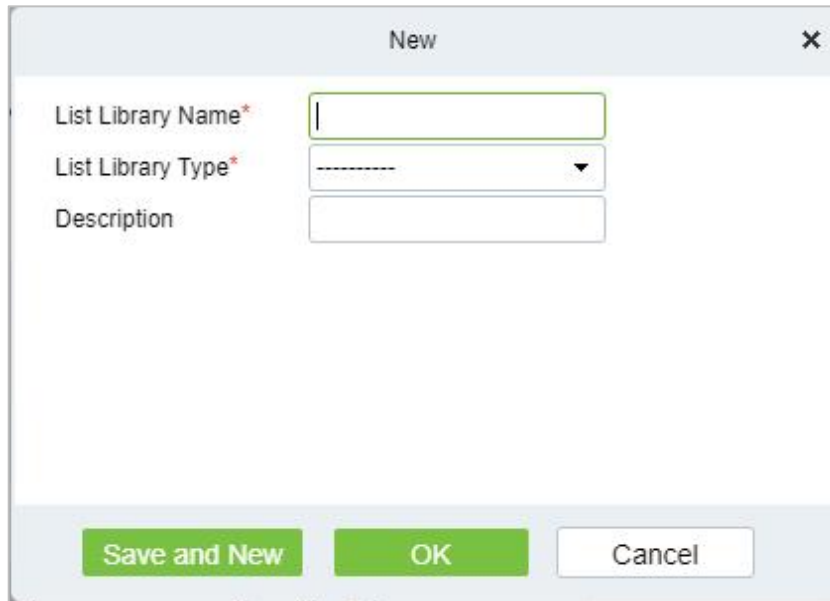

Figure 2- 43 Add List Library (New)

Parameter	Description
List Library Name	Give a name for list library.
List Library Type	Select type of list library.
Description	Fill Description as required.

Table 2- 13 Add List Library

Step 2: Click **OK** to save and exit.

2.1.7.2 Delete

Step 1: Click **Personnel > List Library**, then select **Delete**.

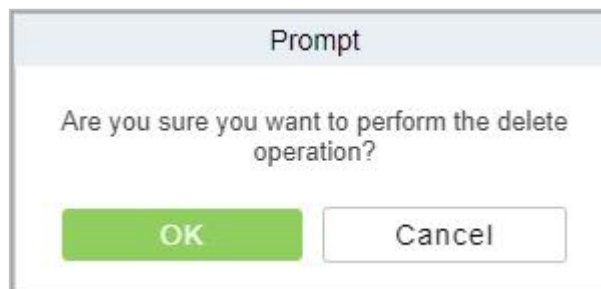

Figure 2- 44 Delete List Library

Step 2: Click **OK** to save and exit.

2.1.8 Parameters

In Parameters you can do few settings for options like **Personnel ID Setting, Card setting, Pending Personnel Selling, Self-Service registration, and Registration Client.**

Click Personnel > Personnel Management, then select Parameters.

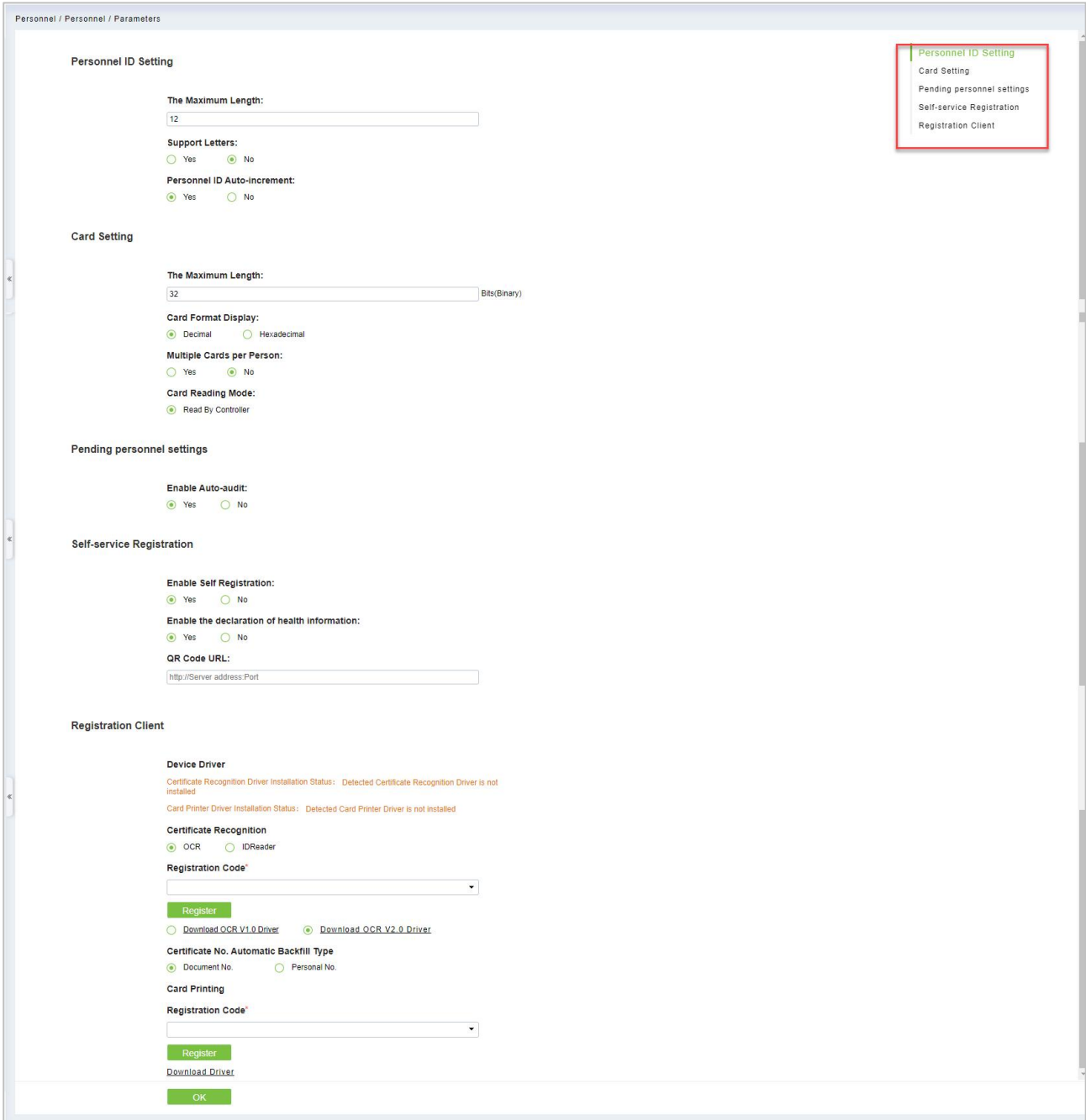

Figure 2- 45 Parameters

2.1.8.1 Personnel ID Setting

The maximum length of ID should be of 12.

Support Letters: yes/No.

Personnel ID Auto-increment: Yes/No.

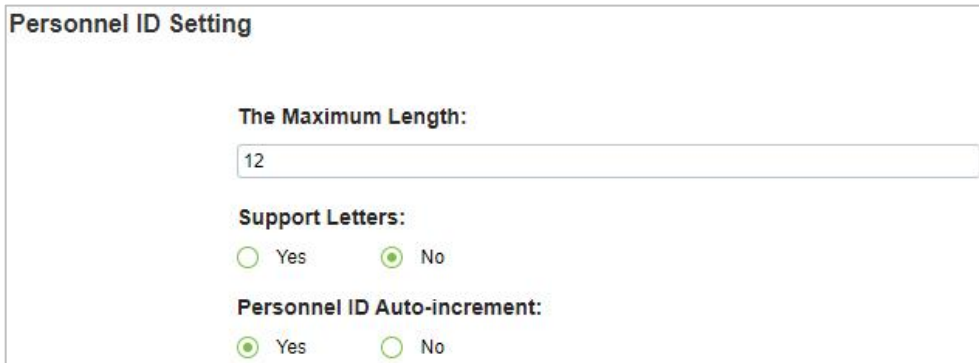

The screenshot shows a configuration window titled "Personnel ID Setting". It contains three sections: "The Maximum Length:" with a text input field containing "12"; "Support Letters:" with two radio buttons, "Yes" (unselected) and "No" (selected); and "Personnel ID Auto-increment:" with two radio buttons, "Yes" (selected) and "No" (unselected).

Figure 2- 46 Personnel ID Setting.

2.1.8.2 Card Setting

The maximum Length is of 32 characters.

Set Card Format display to Decimal or Hexadecimal.

Multiple Cards per Person: Yes/No.

Set Card Reading Mode as Read by controller.

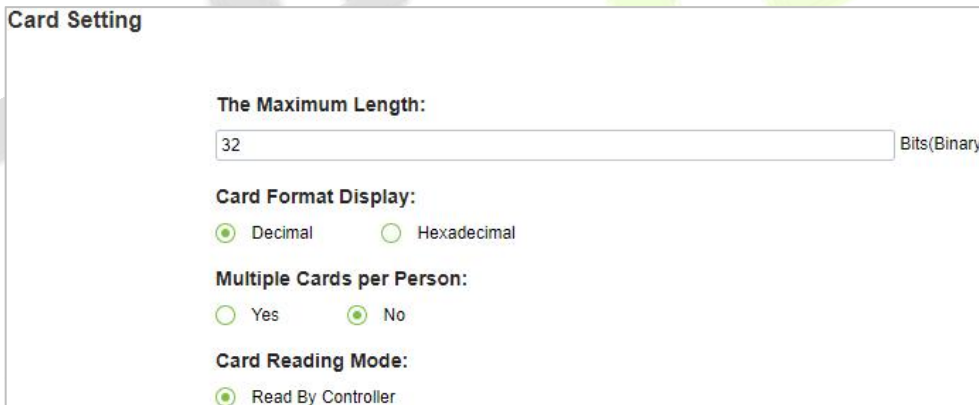

The screenshot shows a configuration window titled "Card Setting". It contains four sections: "The Maximum Length:" with a text input field containing "32" and a label "Bits(Binary)"; "Card Format Display:" with two radio buttons, "Decimal" (selected) and "Hexadecimal" (unselected); "Multiple Cards per Person:" with two radio buttons, "Yes" (unselected) and "No" (selected); and "Card Reading Mode:" with one radio button, "Read By Controller" (selected).

Figure 2- 47 Card Setting

2.1.8.3 Pending Personnel Selling

Enable Auto-audit option to Yes or No.



The screenshot shows a configuration window titled "Pending personnel settings". It contains one section: "Enable Auto-audit:" with two radio buttons, "Yes" (selected) and "No" (unselected).

Figure 2- 48 Pending Personnel Selling

2.1.8.4 Self Service Registration

Change option as Yes or No for Enable Self Registration and Enable the Declaration of health information.

Figure 2- 49 Self Service Registration

2.1.8.5 Registration Client

Fields are as follows:

Figure 2- 50 Registration Client

Click **Ok** to save and exit.

Note:

1. Set the maximum length for a Personnel ID. And whether it will support letters or not. If Personnel ID Auto increment is selected as Yes, then while adding personnel one by one, the ID in field automatically updates to the next new number.
2. Set the maximum length (binary number) of the card number that the current system will support.
3. Set whether the personnel ID for the demission employee can be kept.

4. Set whether the temporary personnel uploaded and registered by scanning the QR code of the big-screen facial recognition time and attendance device need to review.
5. Set the card format currently used in the system. The card format cannot be switched once it is set up.
6. Set whether "Multiple Cards per Person" will be allowed or not.
7. Used the QR code to Self-Registration.
8. Registration Client.
9. If no driver has been installed, the Download Driver link is displayed. Click the link to download and install the driver.

2.2 Card Management

There are three modules in Card Management: Card, Wiegand Format, and Issue Card Record.

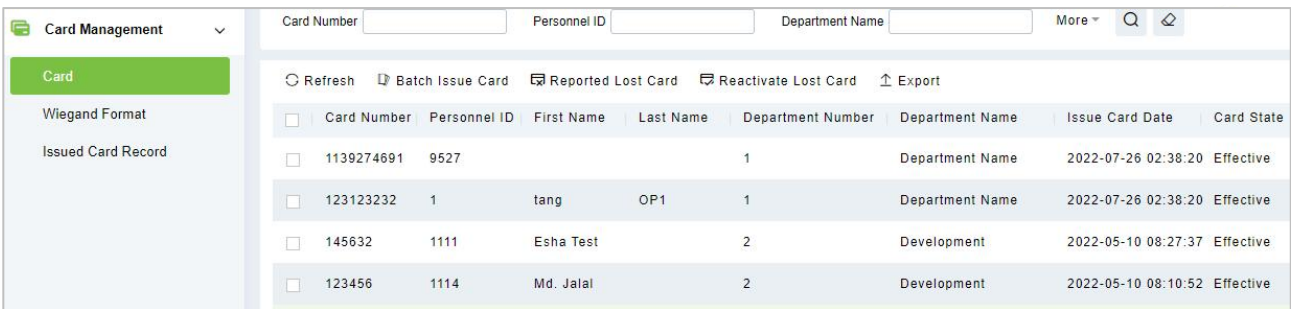

Figure 2- 51 Card Management

2.2.1 Card

2.2.1.1 Batch Issue Card

Click **Personnel > Card Management > Card**, then click **Batch Issue Card**.

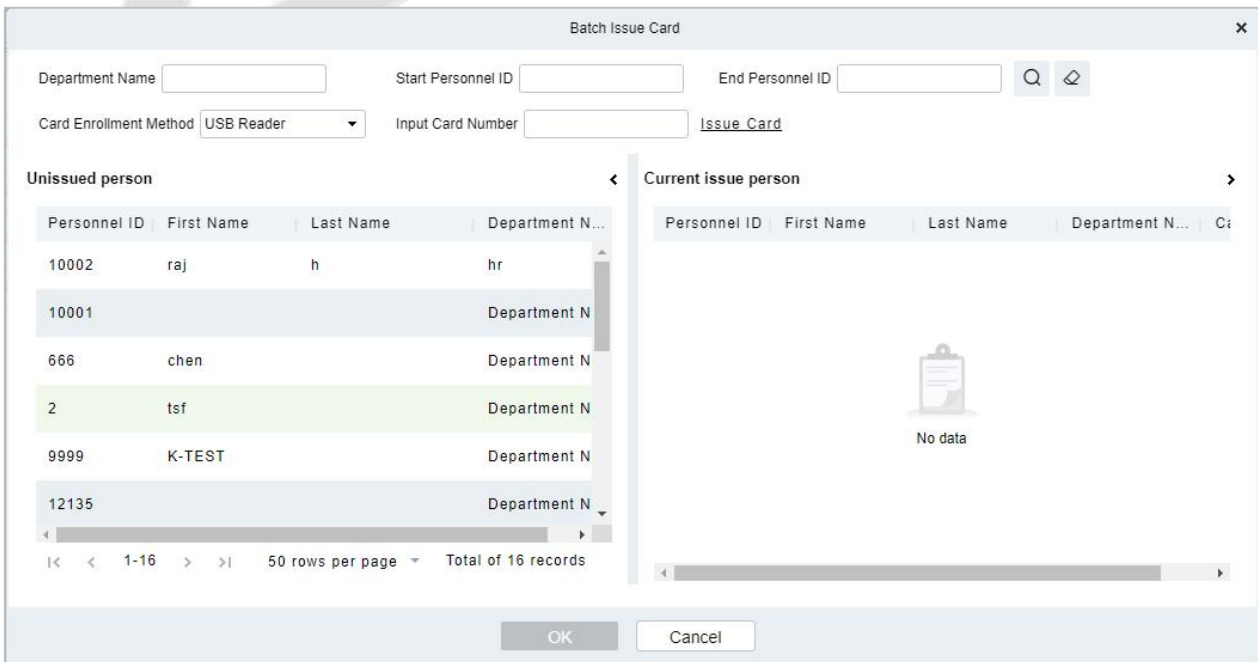

Figure 2- 52 Batch Issue card



Fill the fields for Department Name, Start Personnel ID, End Personnel ID, Card Enrollment Method, and Input Card Number.

Enter Start and End Personnel No. and click **Generate List** to generate personnel list and show all personnel without cards within this number series.

Note: The Start and End Personnel No. only support numbers.

Select Card Enrollment Method: Register with a USB Reader or device.

If you want to enroll a card with a USB Reader, you may place the card over the "issue machine" directly. The System will get the card number and issue it to the user in the list on the left.

For the use of device, you need to select the position of punching, click  start to read, the system will read the card number automatically, and issue it to the user in the list on the left one by one. After that, click  Stop to read.

Note: During the "Batch Issue Card", system will check whether the card issuer issues card or not, if card has been issued before, the system will prompt "The Card Number has already been issued".

Click **OK** to complete card issue and exit.

2.2.1.2 Reported Lost Card:

Click **Personnel > Card Management > Card**, then select **Reported Lost Card**.

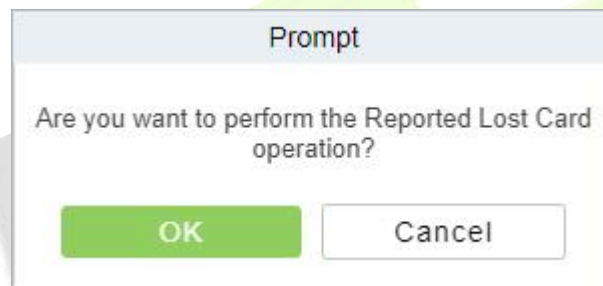

Figure 2- 53 Reported Lost Card

Note: Report Lost Card is applicable to all functional modules, not to the offline elevator module. After the report of loss, the status of the card becomes invalid but not written into the management card. Need to write management card in the appropriate module, such as offline elevator control module **Write management card (Elevator Device > Card > Write management card)**.

2.2.1.3 Reactive Lost Card

Click **Personnel > Card Management > Card**, then select **Reactive Lost Card**.

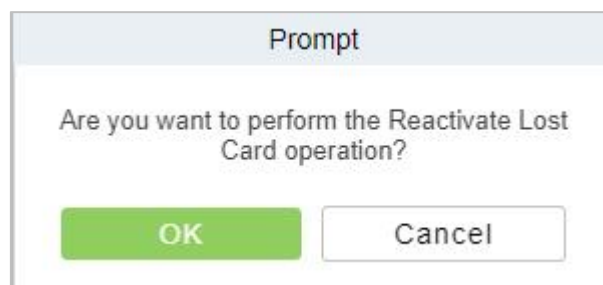
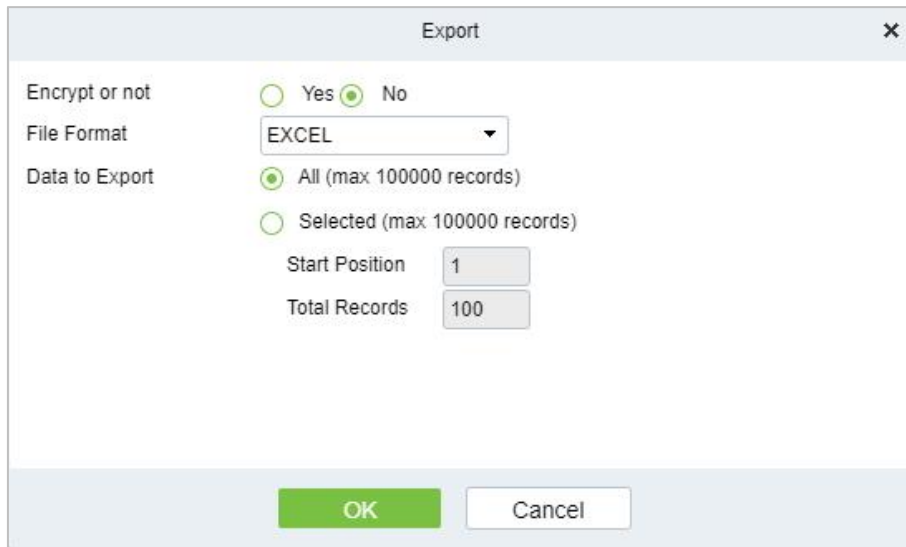

Figure 2- 54 Reactive Lost Card

Note: Reactivate Lost Card is applicable to all functional modules, not to the offline elevator module. After reactivating lost card, the status of the card becomes valid but not written into the management card. Need to write management card in the appropriate module, such as offline elevator control module **Write management card (Elevator Device > Card > Write management card)**.

2.2.1.4 Export

Step 1: Click Personnel > Personnel Management > Card Management > Card, then select Export.



The 'Export' dialog box contains the following fields and options:

- Encrypt or not: Yes No
- File Format: EXCEL (dropdown menu)
- Data to Export: All (max 100000 records) Selected (max 100000 records)
- Start Position: 1 (input field)
- Total Records: 100 (input field)
- Buttons: OK, Cancel

Figure 2- 55 Export

Step 2: Click **OK** to save and exit.

2.2.2 Weigand Format

Wiegand Format is the card format that can be identified by the Wiegand reader. The software is embedded with 9 Wiegand formats. You may set the Wiegand card format as needed.

Click **Personnel > Personnel Management > Card Management**, then select **Weigand Format**.

2.2.2.1 Add weigand Format (New)

Click **Personnel > Personnel Management > Card Management > Weigand format**, then select **New (Add Weigand format)**.

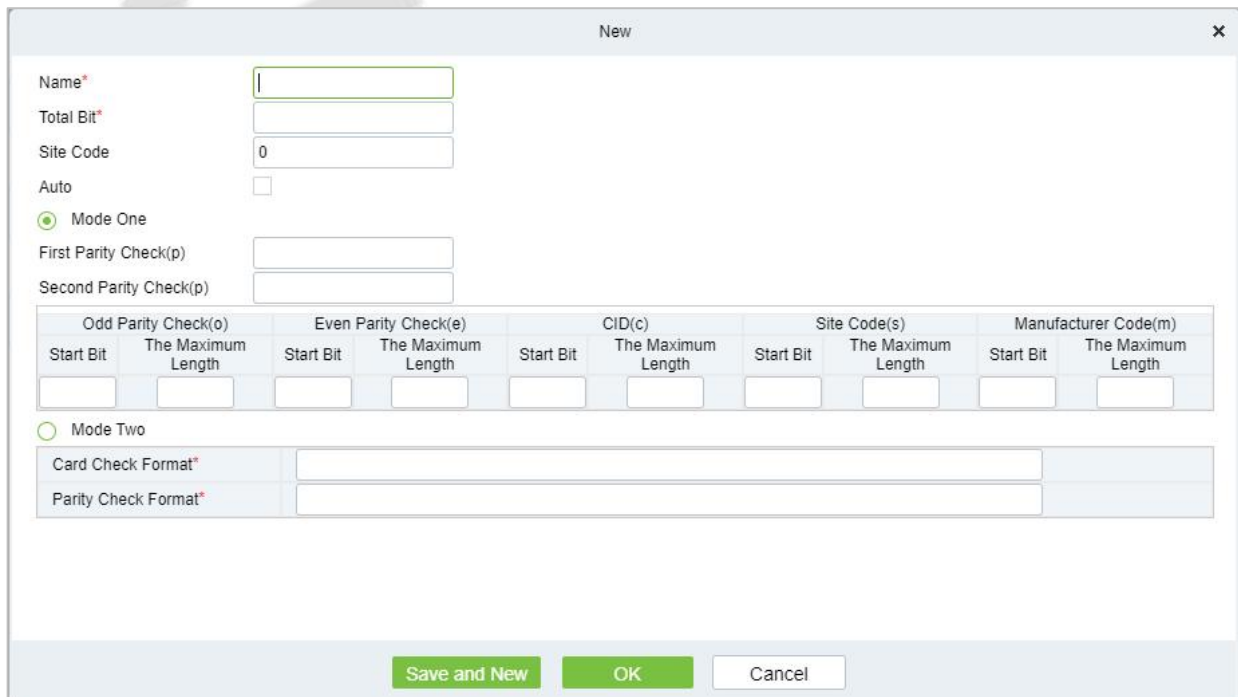

The 'New' dialog box contains the following fields and options:

- Name* (input field)
- Total Bit* (input field)
- Site Code (input field, value: 0)
- Auto (checkbox)
- Mode One (radio button, selected)
- First Parity Check(p) (input field)
- Second Parity Check(p) (input field)
- Table with columns: Odd Parity Check(o), Even Parity Check(e), CID(c), Site Code(s), Manufacturer Code(m). Each column has sub-columns for Start Bit and The Maximum Length.
- Mode Two (radio button)
- Card Check Format* (input field)
- Parity Check Format* (input field)
- Buttons: Save and New, OK, Cancel

Figure 2- 56 Add Weigand format (New)

Fields are as follows:

Parameter	Instructions
Name	Enter the Name.
Total Bit	Enter the total bit.
Site Code	Enter the Site code.
Auto	Click if Auto is required.
Mode One	In Mode One Odd Parity Check, Even Parity Check, CID, Site Code, and Manufacturer Code should be set as Start Bit and The Maximum Length .
Mode Two	In Mode Two Card Check format and Parity check Format must be entered.

Table 2- 14 Weigand Format

This software supports two modes for adding the Wiegand Format: If mode 1 does not meet your setting requirements, you may switch it to mode 2. Take Wiegand Format 37 as an example:

Format Specifying:

“P” indicates Parity Position; “s” indicates Site Code; “c” indicates Cardholder ID; “m” indicates Manufactory Code; “e” indicates Even Parity; “O” indicates Odd Parity; “b” indicates both odd check and even check; “x” indicates parity bits no check.

The previous Wiegand Format 37: the first parity bits (p) check “eeeeeeeeeeeeeeee”; the second parity bits check “oooooooooooooooo”. Card Check Format can only be set “p, x, m, c, s”; Parity Check Format can only be set “x, b, o, e”.

2.2.2.2 Delete

Click **Personnel > Personnel Management > Card Management > Weigand Format**, then select **Delete**.

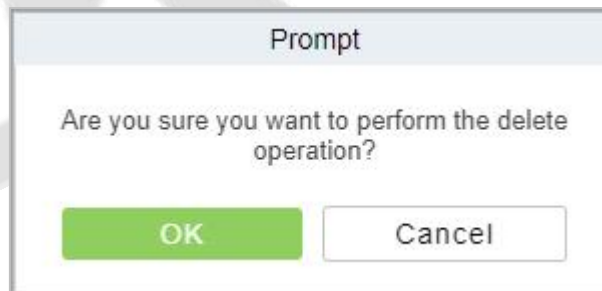

Figure 2- 57 Delete Weigand Format

2.2.2.3 Card Formats Testing

Click **Personnel > Personnel Management > Card Management > Weigand Format**, then select **Card format Testing**.

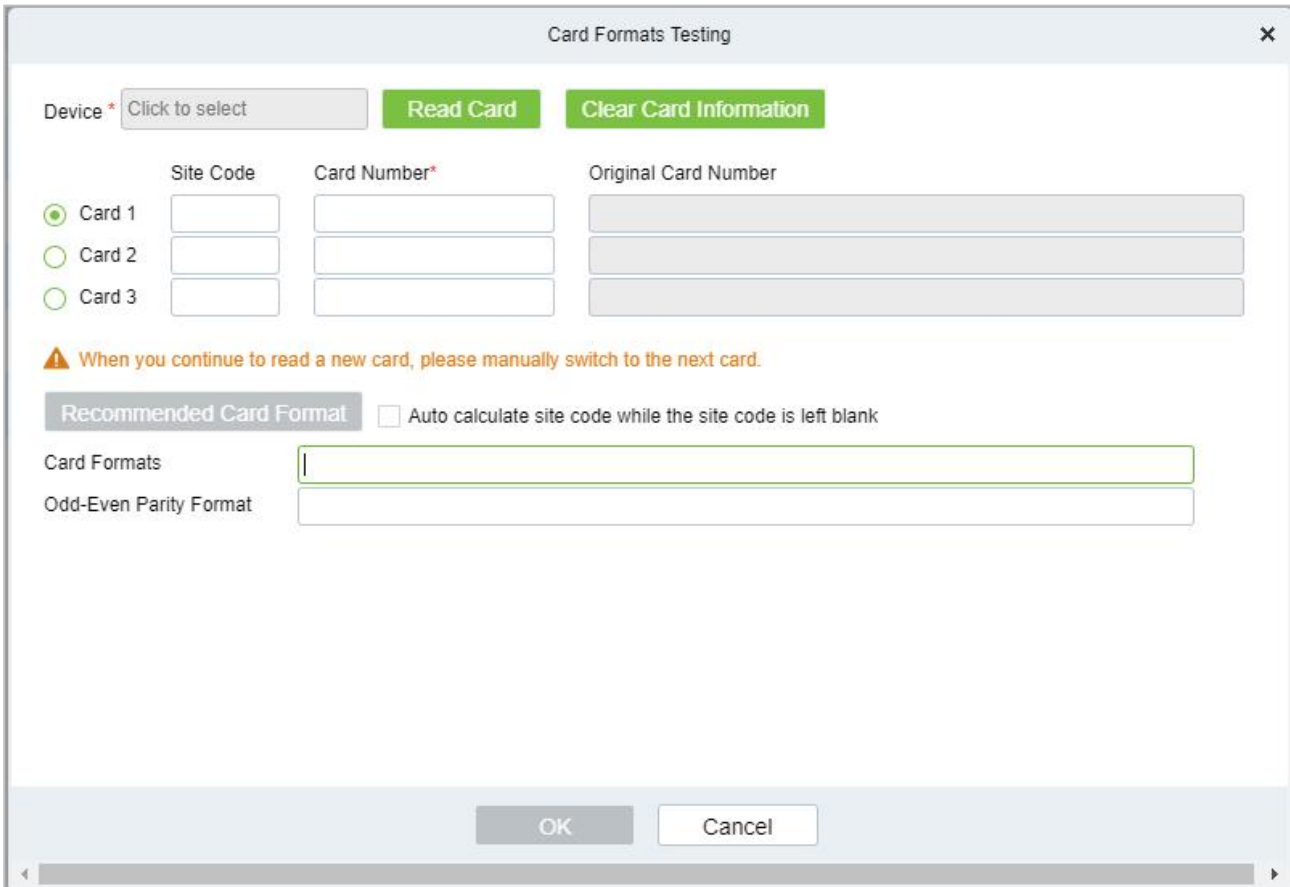

Figure 2- 58 Card Formats Testing

When the card number does not match with the one which is displayed on the system, the user can use the **Card Formats Testing function** to calibrate the Wiegand format. The page is explained as follows:

Select the device that supports the card format test function, and fill the card number and the site code (optional):

Steps:

Click **Read Card** and swipe the card on the reader. The original card number will be displayed on the **Original Card Number** text box.

Click **Recommended Card Format** and the recommended Wiegand card format will be displayed below.

Click **Auto calculate site code while the site code is left bank** and the software will calculate the site code according to the card format and card number.

Click **OK** and the page will jump to the Wiegand format page to save the new Wiegand format.

Note: The card format testing function is only supported by few devices.

2.2.3 Issue Card Record

Click **Personnel** > **Personnel Management** > **Card Management**, then select **Issue Card Record**.

2.2.3.1 Export

Step 1: Click **Personnel** > **Personnel Management** > **Card Management** > **Issue Card Record**, then select **Export**.

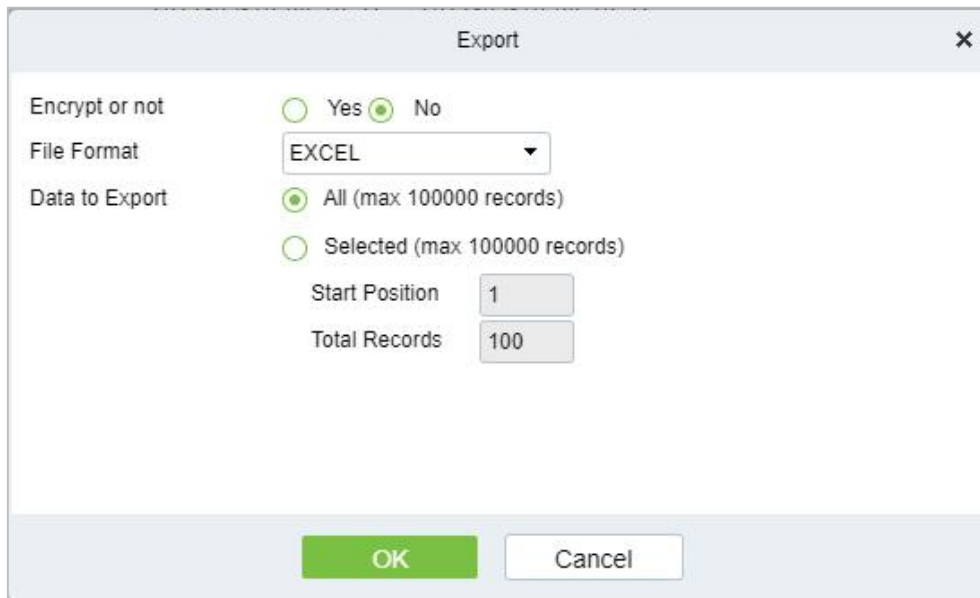

The screenshot shows an 'Export' dialog box with the following settings:

- Encrypt or not: Yes No
- File Format: EXCEL
- Data to Export: All (max 100000 records) Selected (max 100000 records)
- Start Position: 1
- Total Records: 100

Buttons: OK, Cancel

Figure 2- 59 Issue Card Record

Step 2: Click **OK** to save and exit.

3 Access Control

3.1 Operation Scenario

The **Access Control** module is used as the entry and exit management of pedestrians. Through the configuration of access control equipment and permission groups, unified management of entry and exit of people is realized. The most fundamental problem to solve is to control who uses what media to enter and exit which door at what time.

3.2 Operation Process

This section describes the configuration process of the **Access Control** module service.

The **Access Control** module service configuration process is shown in Figure 3-1.

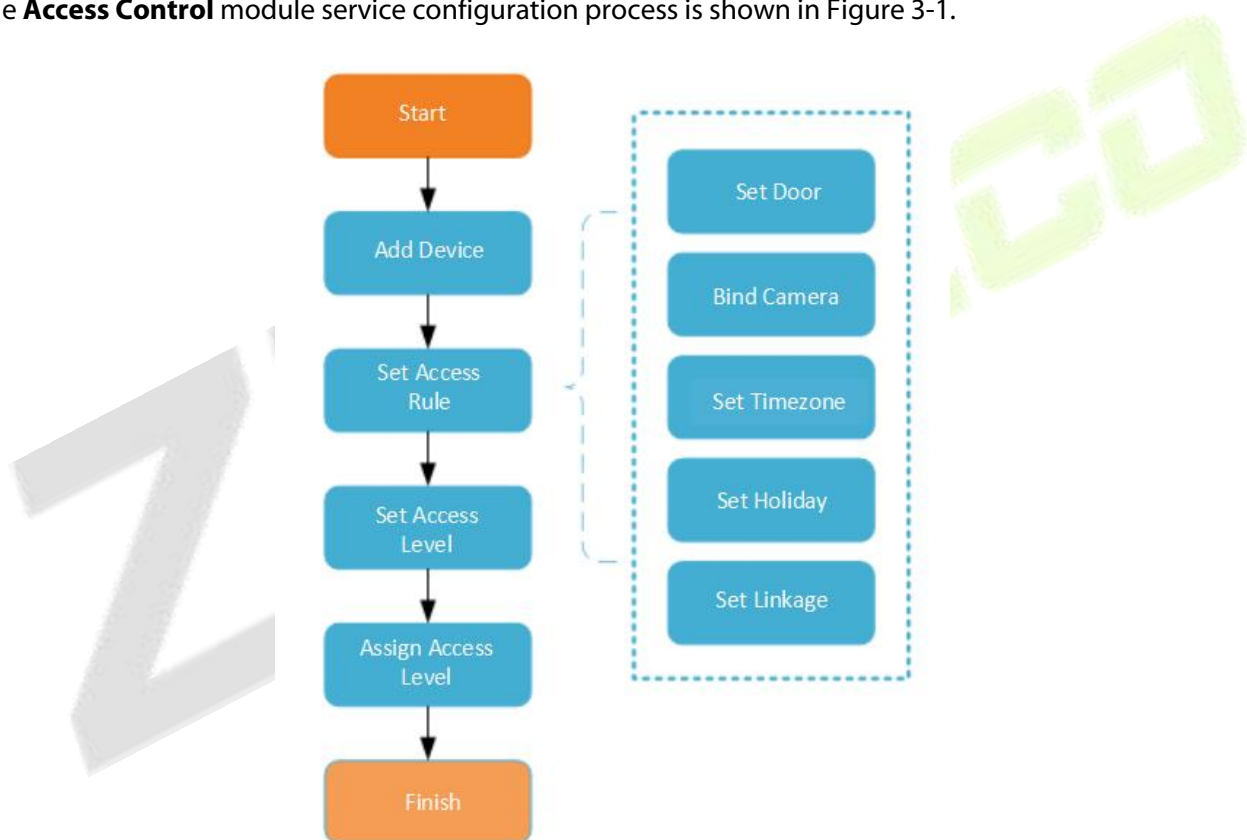

Figure 3- 1 Access Control Configuration Process

3.3 Access Device

3.3.1 Device

Introduce the configuration Steps of searching and adding access control devices in ZKBioCVSecurity.

Through the search method, the access control devices that have been set to point to the server can be found, and the access control devices that have been searched can be added directly, which is convenient to operate.

Preconditions:

1. Before adding the **Access Control** device, perform IP allocation settings.
2. The device needs to set the server address in advance before searching and adding. The configuration Steps for the server are as follows:
 - a. In the access control device that has been connected to the power supply and the network, set it directly on the device screen.
 - b. Select and click "Main Menu > Communication Equipment > Network Management Platform or Cloud Server Settings"
 - c. Set the IP address and port of the current server, that is, the IP address and port of the current ZKBioCVSecurity server and complete the configuration to the server.

3.3.1.1 Add devices (New)

Steps:

Step 1: In the **Access Control** module, select "**Device > Access Control Device**".

Step 2: On the device interface, click the "search" button to pop up a search box.

Step 3: Click "start **Search**" in the search box to display the **access control devices** that can be added, as shown in Figure 3-2.

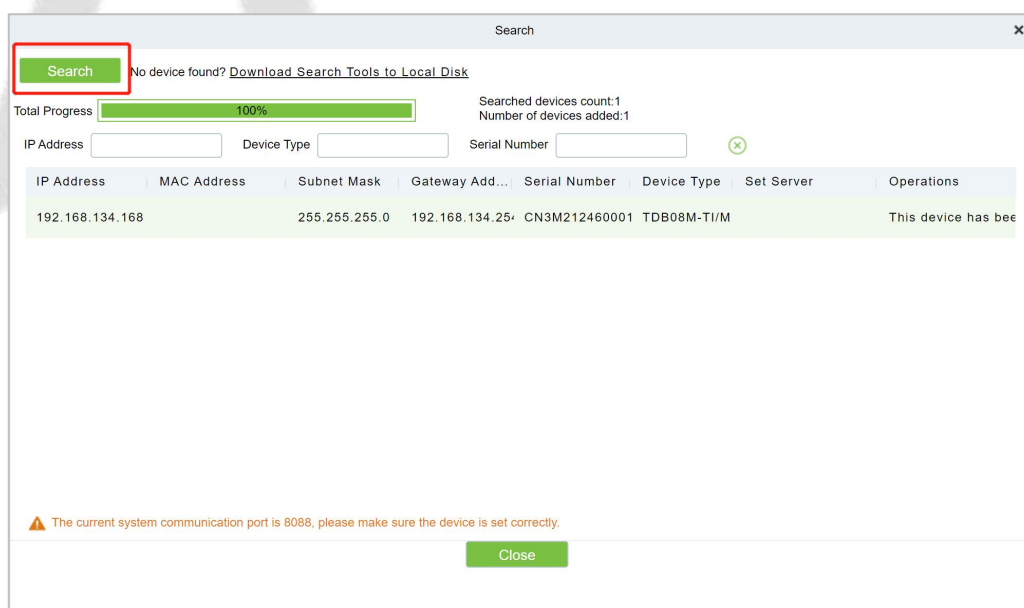

Figure 3- 2 Device Search and Add Interface

Step 4: Optional: Modify the IP address of the **Access Control** device, click "**Modify IP Address**", the device will be restarted after modifying the IP address, and the IP address modification will be completed after the restart.

Step 5: For the searched access control devices, click the **Add** button in the operation bar to add the device; the device addition settings are shown in Figure 3-3, and the parameter settings are described in Table 3-3.

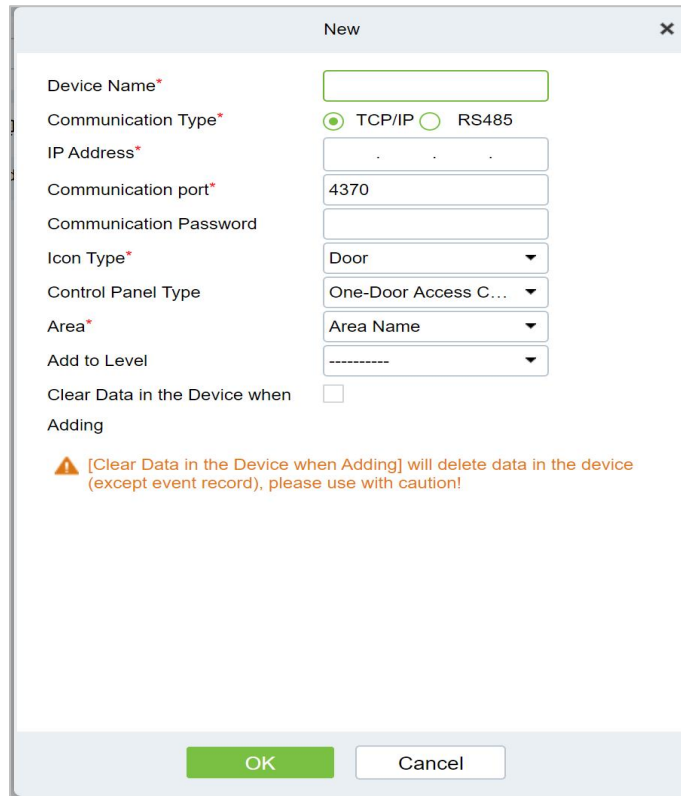

Figure 3- 3 Device Add Interface

Parameter	How to set
Device Name	Customize the name of the device.
New Server Address/Port	Set the IP address and communication port of the system to be used (the default communication port is 8088).
Communication Password	Fill in the communication password of the device. If there is no password, you do not need to fill in it. You can add it only after the verification is successful. For new factory equipment and initialized equipment, the communication password is empty. In order to ensure that the device is not used by others, users can enter the device IP address through the web page to enter the background to customize the device verification password.
Icon Type	Select the icon display type of the real-time monitoring interface: door, channel.
Area	Divide the device into regions and select the region to which the device belongs.
Add To Permission Group	The device is automatically added to the selected permission group.
Delete Data From Device When Adding	Set whether the original Access Control data in the device will be automatically cleared after the device is added.

Table 3- 1 Parameter setting

Step 6: Click **OK** to complete the operation of adding access control devices. After the operation is

completed, the device will restart, and the device will be added after the restart is complete.

Step 7: Click **Close** to close the device search and add interface.

3.3.1.2 Delete

Select device, click **Delete**, and click **OK** to delete the device.

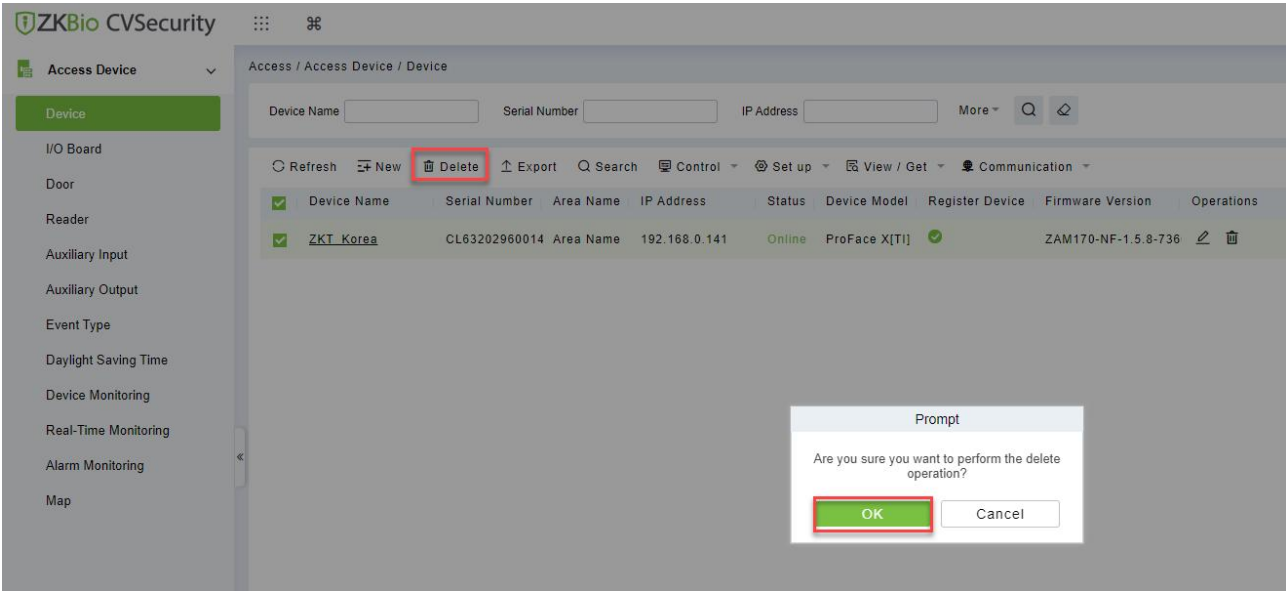

Figure 3- 4 Device Add Interface

3.3.1.3 Export

Device information can be exported in EXCEL, PDF, CSV file format.

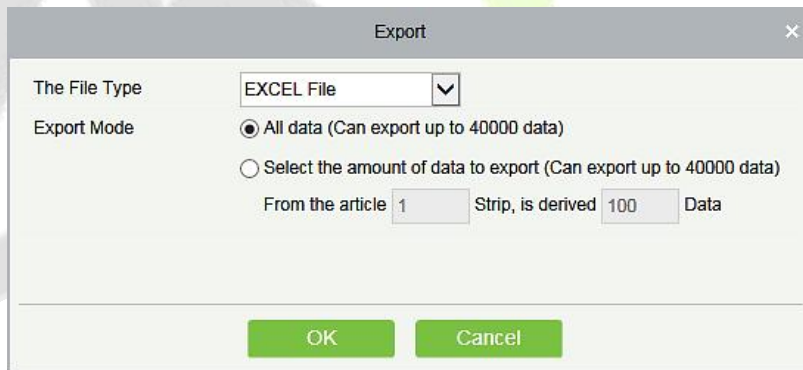

Figure 3- 5 Export

ZKTECO Device										
Device Name	Serial Number	Area Name	Communication Type	Network Connection Mode	IP Address	RS485 Parameter	Enable	Device Model	Register device	Firmware Version
192.168.218.80	20100501999	Area Name	HTTP	Wired	192.168.218.80		Enable	C3-400Pro		AC Ver 4.7.7.3033 Jun 16 2017

Figure 3- 6 Export

3.3.1.4 Control

● Clear Administration Permission

Administration has permission to clear the administration permission from device.

● Upgrade Firmware

Tick the device that needs to be upgraded, click **Upgrade firmware** to enter edit interface, then click

Browse to select firmware upgrade file (named emfw.cfg) provided by Access software, and click **OK** to start upgrading.

Note: The user shall not upgrade firmware without authorization. Contact the distributor before upgrading firmware or upgrade it following the instructions of the distributor. Unauthorized upgrade may affect normal operations.

- **Reboot Device**

It will reboot the selected device.

- **Synchronize Time**

It will synchronize device time with server’s current time.

- **Disable/Enable**

Select device, click **Disable/Enable** to stop/start using the device. When communication between the device and the system is interrupted or device fails, the device may automatically appear in disabled status. After adjusting local network or device, click **Enable** to reconnect the device and restore device communication.

- **Synchronize All Data to Devices**

Synchronize data of the system to the device. Select device, click **Synchronize All Data to Devices** and click **OK** to complete synchronization.

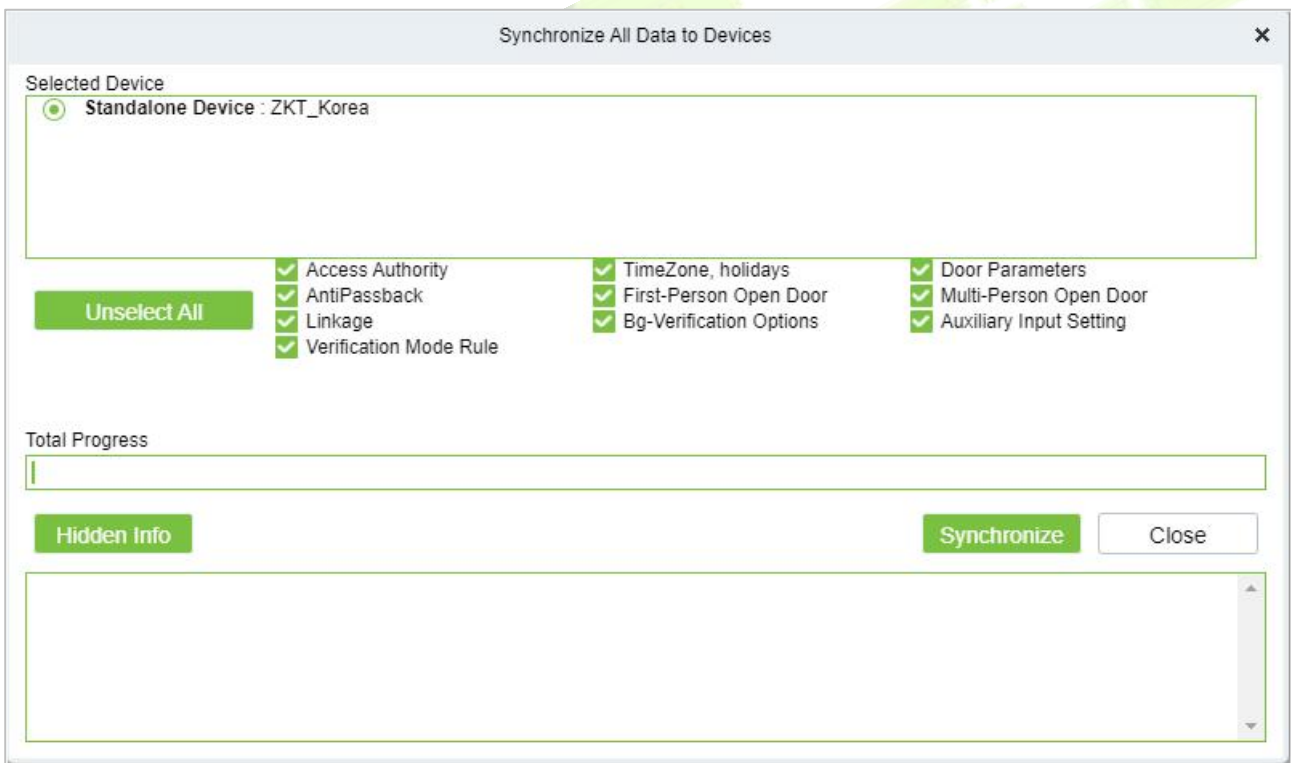

Figure 3- 7 Synchronize All Data to Devices

Note: **Synchronize All Data to Devices** will delete all data in the device first (except transactions), and thus download all settings again. Please keep the internet connection stable and avoid power down situations. If the device is working normally, please use this function with caution. Execute it in rare user situations to avoid impact on normal use of the device.

3.3.1.5 Set Up

- **Set Background Verification Parameters:**

Select the required online device; click **More** > **Set Bg verification parameters**.

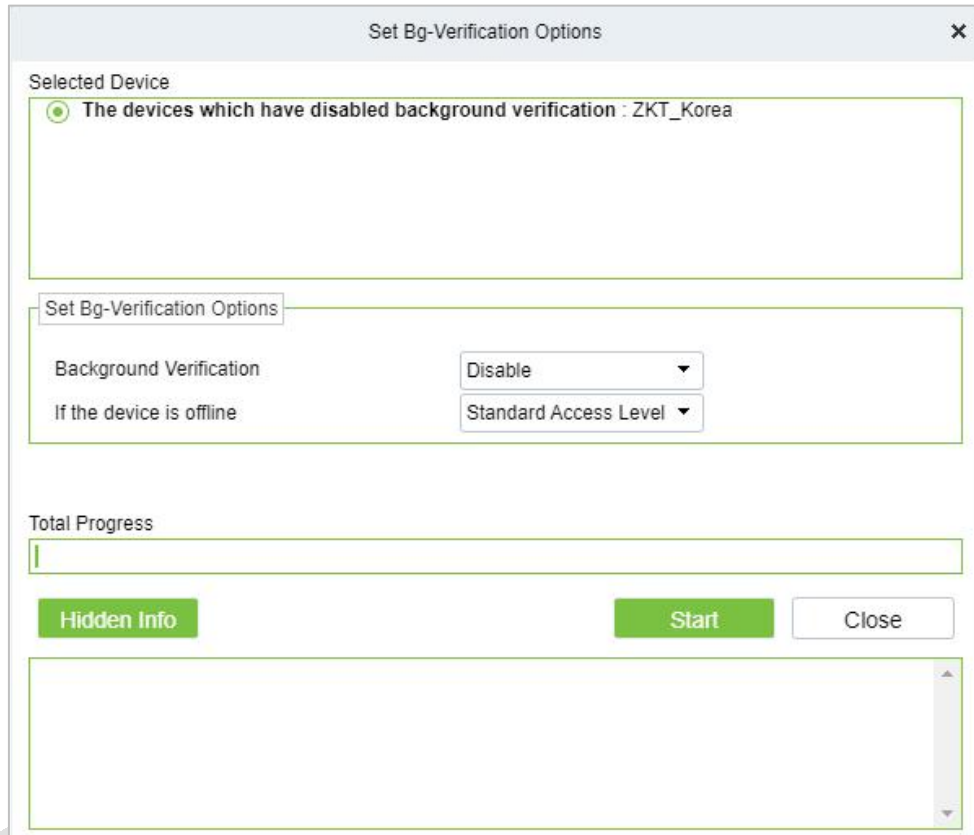

Figure 3- 8 Set Bg-Verification Parameters

Background verification: Enable or Disable Background verification function.

If the device is offline: If the controller is offline, the device has levels of Standard Access Level or Access Denied.

After setting parameters, click **Start** button to issue command to the device setting.

Note: If you need advanced access control functions, please enable Background verification, and issue the background verification parameters to the device.

- **Set the Registration device**

Set the registration device only when the standalone device’s data such as personnel can automatically upload.

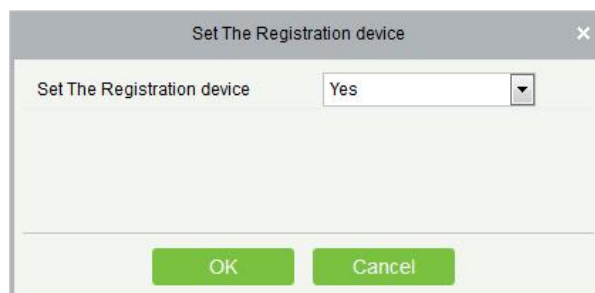

Figure 3- 9 Set the Registration device

- **Set Device Time Zone**

If the device supports the time zone settings and is not in the same time zone with the server, you need to set the time zone of the device. After setting the time zone, the device will automatically synchronize the time according to the time zone and server time.

- **Modify the Fingerprint Identification Threshold** (Ensure that the access controller supports fingerprint function)



Figure 3- 10 Modify the Fingerprint Identification Threshold

Users can modify the fingerprint identification thresholds in the devices; it ranges from 35 to 70 and it is 55 by default. The system will read the thresholds from the device. Users can view the thresholds devices list. More than one device can be changed by using Batch operation function.

Set Device In/Out Status: We can set the status of device In/Out

Set Extended Parameters: We can set the extended parameters of device like temperature detection and mask detection

Set Video Intercom Server: We can set the video intercom server of device

3.3.1.6 View/ Get

- **Get Device Option**

It gets the common parameters of the device. For example, get the firmware version after the device is updated.

- **Get Personnel Information**

Renew the current number of personnel, fingerprints, finger vein and face templates in the device. The final value will be displayed in the device list.

- **Get Transactions**

Get transactions from the device into the system. Two options are provided for this operation: Get New Transactions and Get All Transactions.

- **Get New Transactions**

The system only gets new transactions since the last collected and recorded transaction. Repeated transactions will not be rewritten.

- **Get All Transactions**

The system will get transactions again. Repeated entries will not be shown twice.

When the network status is healthy and the communication between the system and device is normal, the system will acquire transactions of the device in real-time and save them into the system database. However, when the network is interrupted or communication is interrupted for any reasons, and the transactions of the device have not been uploaded into the system in real-time, Get Transactions can be used to manually acquire transactions of the device. In addition, the system, by default, will automatically acquire transactions of the device at 00:00 on each day.

Note: Access controller can store up to 100 thousand of transactions. When transactions exceed this number, the device will automatically delete the oldest stored transactions (deletes 10 thousand transactions by default).

● **View Rules of Devices**

Shows the Access rules in the device.

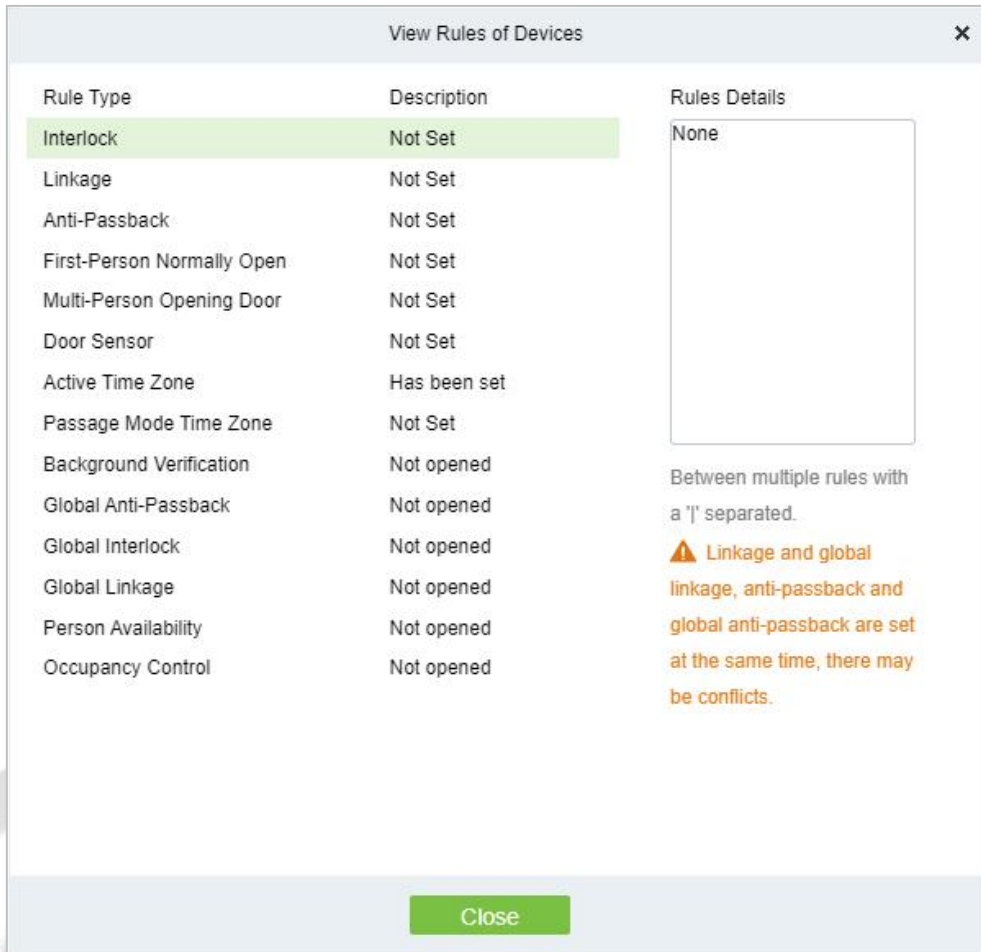

Figure 3- 11 View rules of device

● **View Device Capacity**

It checks the capacity of personnel’s biometric details in the device.

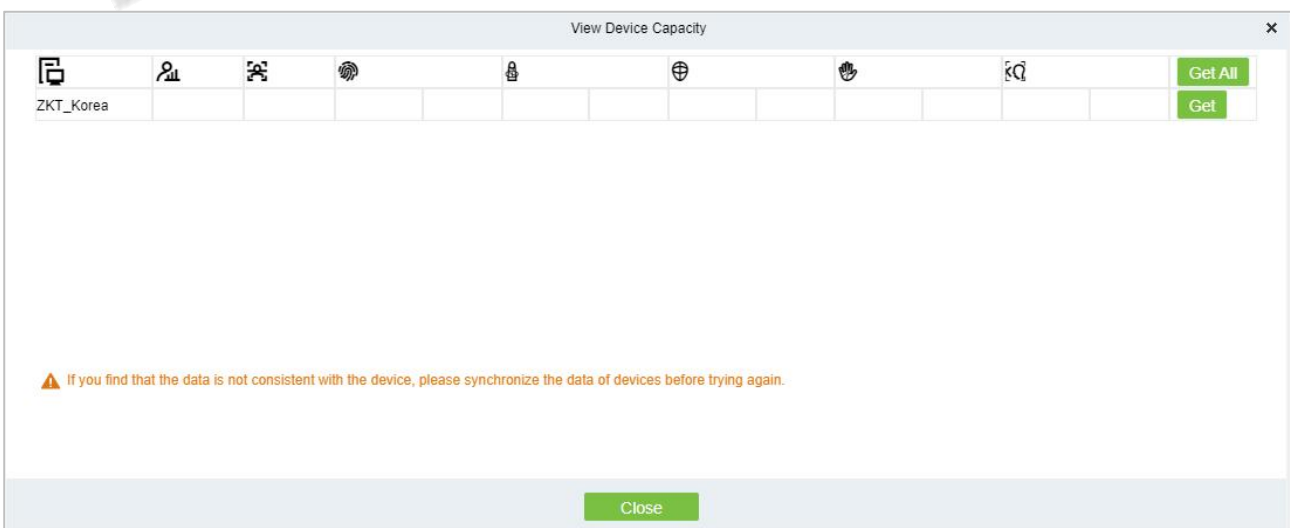

Figure 3- 12 View device capacity

3.3.1.7 Communication

- **Modify Ip Address**

Select a device and click **Modify IP address** to open the modification interface. It will obtain a real-time network gateway and subnet mask from the device. (Failed to do so, you cannot modify the IP address). Then enter a new IP address, gateway, and subnet mask. Click **OK** to save and quit. This function is the similar as Modify IP Address Function in Device.

- **Modify Communication Password**

The system will ask for the old communication password before modifying it. After verification, input the new password twice, and click **OK** to modify the communication password.

Note: Communication password shouldn't contain spaces; it is recommended to use a combination of numbers and letters. Communication password setting can improve the device's security. It is recommended to set communication password for each device.

- **Modify Rs485 Address**

Only the devices that use RS485 communication and with no DIP Switch can modify RS485 address.

- **Switch Network Connection**



Figure 3- 13 Switch network connection

This function is applicable to InBio5 series access control panels, which is used to switch among different network connection modes of the control panel.

3.3.1.8 Device Replacement

Introduce the configuration Steps for replacing access control devices in ZKBioCVSecurity.

When a device is unavailable, we can quickly add a new device and synchronize all configurations from faulty device to the new device by simply entering the serial number of the replaced device.

Step 1: Go to the **Access > Access Device**, select the unavailable device.

Device Name	Serial Number	Area Name	IP Address	Status	Device Model	Register Device	Firmware Version	Operations
10.8.14.206	COKC22026004	Area 1	10.8.14.206	Offline	SpeedFace M4		ZAM180-NF50VA-Ver3	

Figure 3- 14 Select the Unavailable Device

Step2: Click **Set up > Replace Device**.

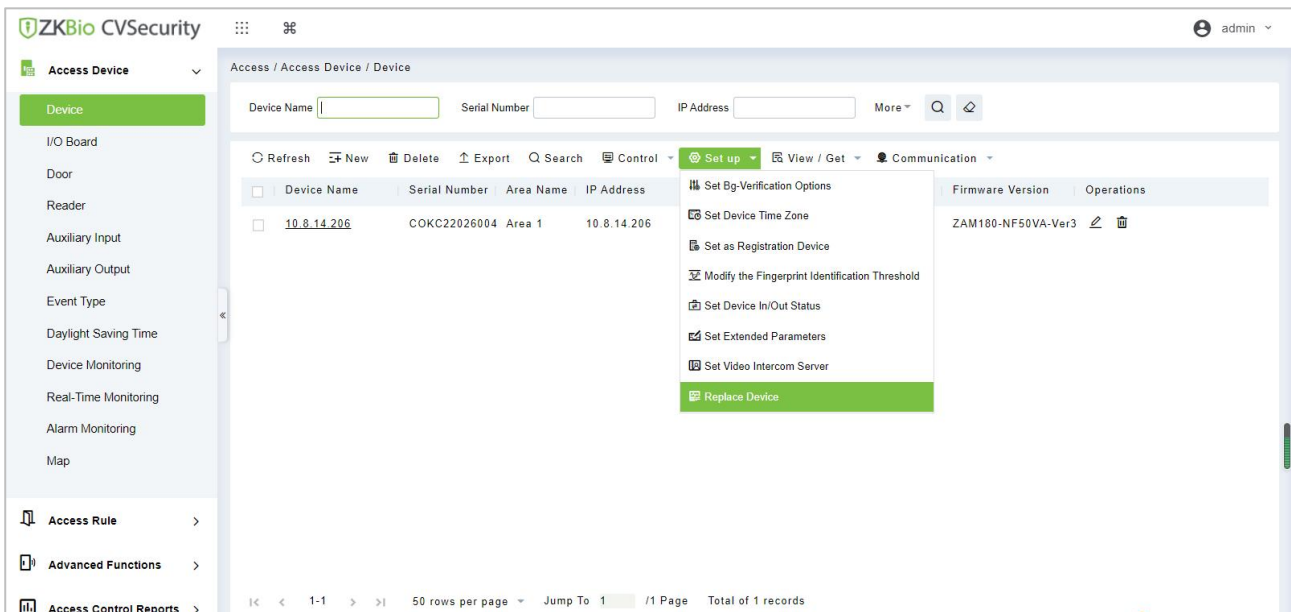

Figure 3- 15 Replace Device

Step 3: Enter the serial number of the new device, then click **OK**.

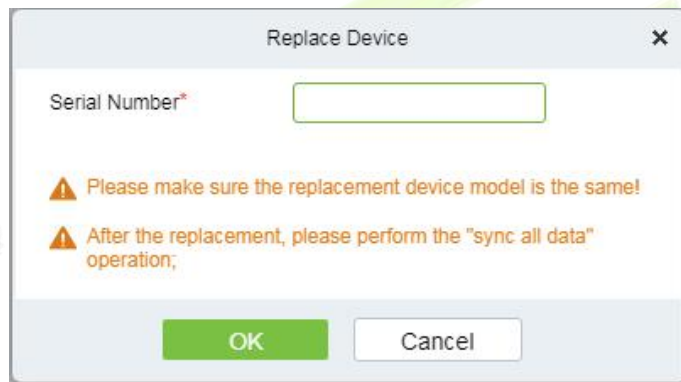

Figure 3- 16 Input the Serial Number

Step 4: Select the new device, then click **Control > Enable**.

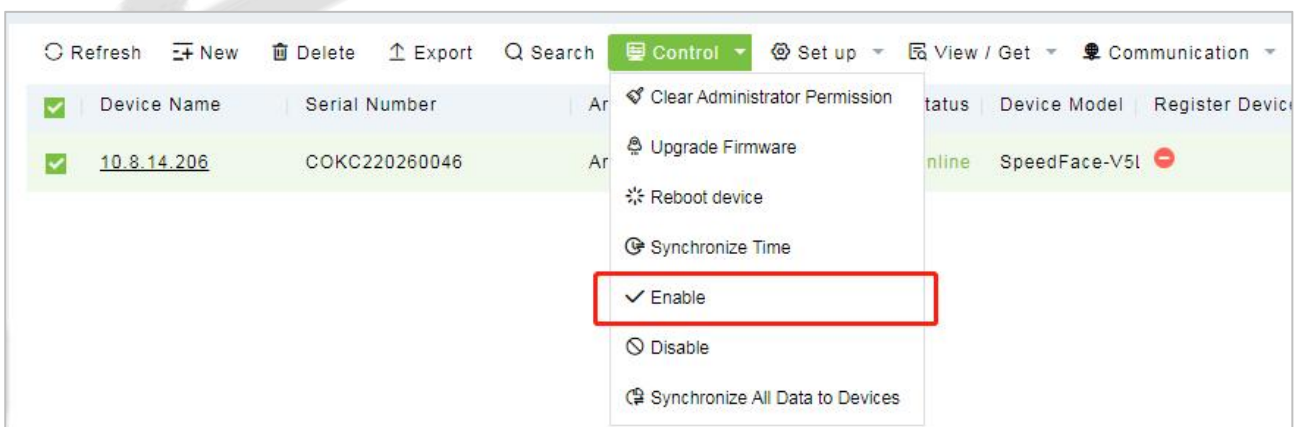

Figure 3- 17 Enable Device

Step 5: Select the new device, then click **Control > Synchronize All Data to Device**.

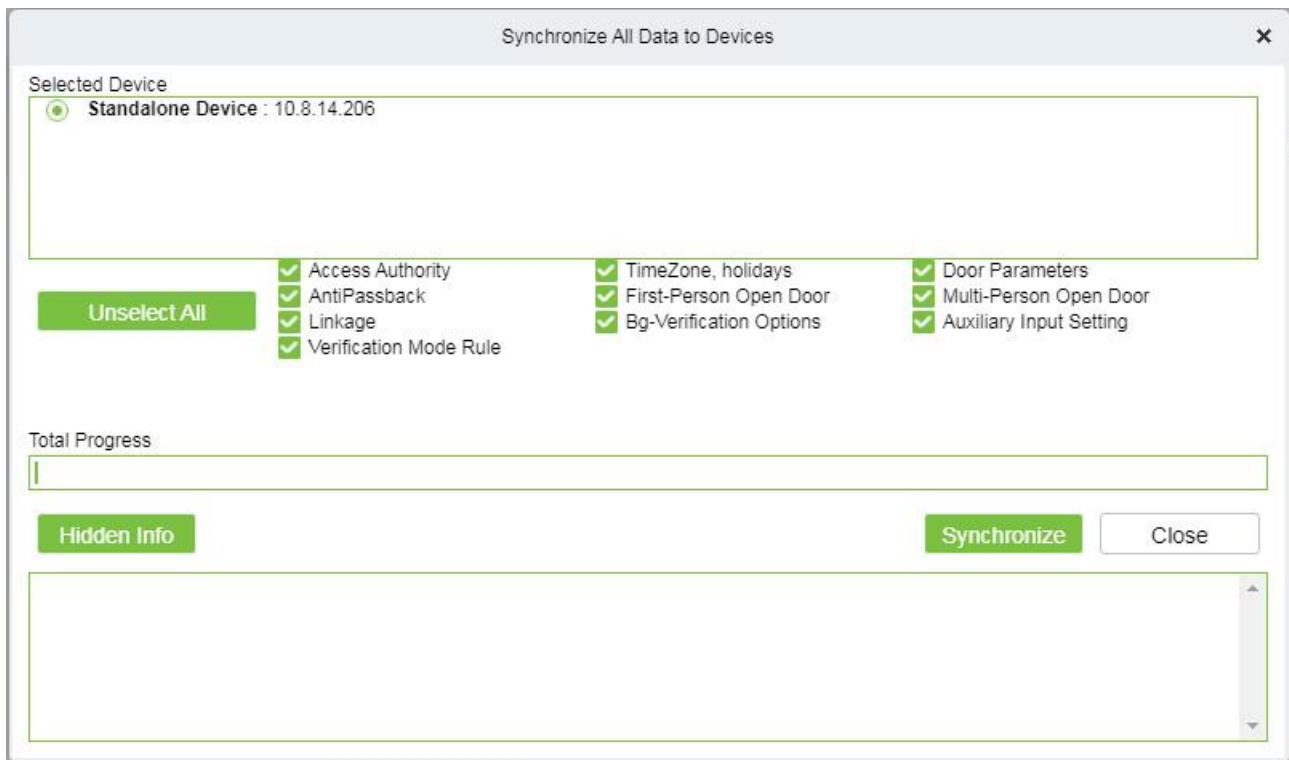

Figure 3- 18 Synchronize Device Data

Note:

1. Before replacement, the device needs to configure the server address and IP allocation.
2. Make sure that the replacement device model is the same.
3. After the replacement, please perform the "sync all data" operation.

3.3.2 Door

The setting of door parameters affects the logic judgment of access control verification. The door parameters support different parameter settings according to the different firmware of the device. The following describes the configuration Steps of the door parameters with one of the devices.

Operation Step:

Step 1: In the **Access Control** module, select "**Devices > Door**".

Step 2: In the management interface of the door, click the **Edit** button in the door operation bar to pop up the door parameter setting box.

Step 3: In the door parameter setting interface, fill in the corresponding parameters according to the addition requirements, as shown in Figure 3-4, please refer to Table 3-2 for parameter filling instructions.

Figure 3- 19 Setting Door Parameters

Instructions:

The firmware of different access control devices supports different door parameters. Set the parameters based on the actual door parameter page. Table 3-4 describes the parameter set for different devices.

Parameter	Setup Instructions
Device Name/Door Number	The basic information about the door is displayed. Reset is not supported.
Name of the Door	Customize the name of the door for easy memory.
Gate Validity Period	Select a period when the gate is valid. Not within the validity period of this door, even if the person has the permission of this door, can not open the door inside.
Verify The Way	Set this parameter to the authentication mode supported by the device.
Lock Drive Duration	Set the time range for unlocking a lock after authentication. For example, if the value is set to 5 seconds, the door can be opened within 5 seconds after the verification. If the door is not opened after 5 seconds, the door will be automatically locked, and the door can be opened only after the verification.
Weiganka Format	Select a Weigand card format that can be recognized by the door’s Weigand reader. The card format and Settings are different, will not open the door. There are 9 built-in formats in the software, the default is automatic matching wiegand card format, automatic matching can identify a variety of built-in wiegand card format.
Exit Button State	Set the status of the door exit button, locked, not locked. Lock: the door lock does not open after pressing the exit button. Not locked: the door lock is opened after pressing the exit button.
The Exit Button Is	When the exit button is set to lock, set the delay time of the exit button, that is,

Parameter	Setup Instructions
Delayed	the delay time of the inspection door alarm after the exit button is locked.
Operation Interval	Set the interval for Access Control Operation.
Effective Time of Exit Button	Select the time period for setting the exit button.
Magnetic Door Type	Option No, normally open, normally closed, default none.
Behind Closed Doors to Lock	Set whether to lock back after the door is closed.
Magnetic Door Delay	Set the delay for checking the door status sensor after the door is opened. When the door is not "normally open", if it is open, it will start timing, alarm will start after the door magnetic delay time, and alarm will be cancelled when the door is closed.
Duration Of Anti-Passback Entry	Set a limit on how long an intelligent entry can take.
Stress The Password	Set up the user to open the door when the threat password. An alarm will be generated when the coerced code opens the door.
Emergency Code	Set a password for the user to use in an emergency. The password is used by the administrator and is valid in any period and authentication mode.
The Door Is Normally Open	Select the time when this door is normally open.
Extended Time of Passage	Set on the basis of the original opening time, additional limit time. Common terms for participants, inconvenient personnel to extend the passage time.
Open Time Delay	Set the time for waiting for the delayed door opening after authentication.
Disable Alarm Reminder	If alarm event occurs on this door, whether there will be alarm sound reminder on the real-time monitoring interface.
Allow Superuser Access When the Door Is Locked	Set whether the super user can verify access when the door is locked.
The Above Settings Are Copied To	To set the door parameters above, the options are all doors of the current device, all doors of all devices.

Table 3- 2 Door Parameters

Step 4: Click **OK** to complete the setting of the door parameters

Remote Opening/Closing: It can control one door or all doors.

To control a single door, right click over it, and click **Remote Opening/ Closing** in the pop-up dialog box. To control all doors, directly click **Remote Opening/ Closing** behind Current All.

In remote opening, user can define the door opening duration (The default is 15s). You can select **Enable Intraday Passage Mode Time Zone** to enable the intraday door passage mode time zones, or set the door to Normal Open, then the door will not be limited to any time zones (open for 24 hours).

To close a door, select **Disable Intraday Passage Mode Time Zone** first, to avoid enabling other normal open time zones to open the door, and then select **Remote Closing**.

Note: If **Remote Opening /Closing** fails, check whether the devices are disconnected or not. If disconnected, check the network.

Cancel the alarm: Once an alarming door is displayed on the interface, the alarm sound will be played. Alarm cancellation can be done for single door and all doors. To control a single door, move the cursor over the door icon, a menu will pop-up, then click **Remote Opening/Closing** in the menu. To control all doors, directly click **Remote Opening/Closing** behind Current All.

Note: If **Cancel the alarm** fails, check if any devices are disconnected. If found disconnected, check the network.

Remote Normally Open: It will set the device as normal open by remote.

Activate Lockdown: It will remotely set the door status to locked status. After this, the door wouldn't receive any operations, such as card reading and remote operations. This function is supported only by certain devices.

Deactivate Lockdown: It will unlock a locked door. This function is supported only by certain devices.

3.3.3 Reader

This section describes the Step configuration of the Reader binding camera in ZKBio CVSecurity.

Operation Scenario:

After the camera is bound, if related Settings are set during linkage, the Reader will perform video linkage (capture) once corresponding events occur. The Reader bind cameras in the same way. This section uses the Reader as an example to describe how to bind cameras.

The Premise Conditions:

A video camera has been added in the **Video Management** module.

Operation Step:

Step 1: In the access **Control** module, choose "**Device > Reader**".

Step 2: In the Operation column of the corresponding Reader, click Bind/Unbind camera. The bind/unbind camera page is displayed.

Step 3: On the Select Reader screen, set the Reader as required, as shown in Figure.

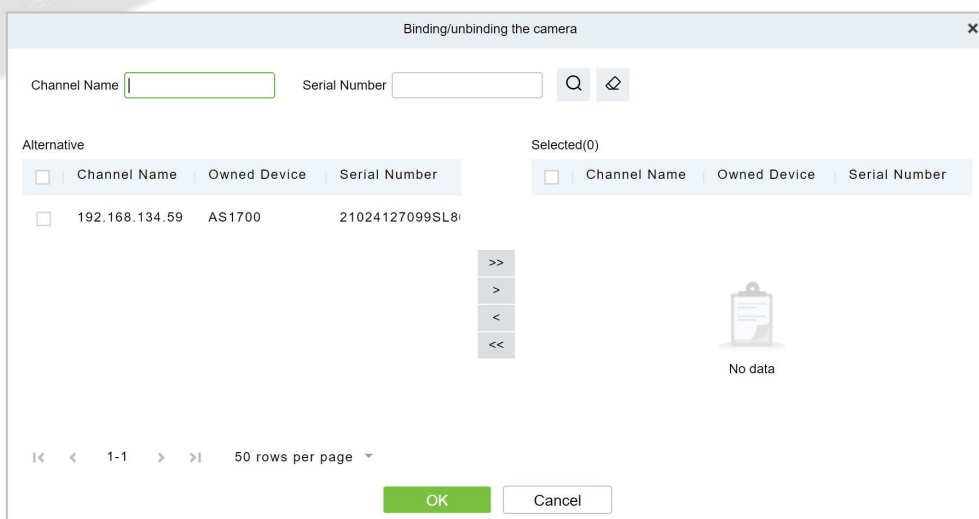

Figure 3- 20 Binding A Camera

Step 4: Click **OK** to bind the camera.

Parameter	How to set
Device Name	Customize the name of the device.
Reader Name	Display the reader's name of the device
Communication Type	Wiegand/RS485, Wiegand, RS485, and Disabled are available. When a communication type is selected, the reader interface on the device will receive data (including card and fingerprint data) for the specified type only
In/Out	Display the in/out of the device.
Bound Camera	connecting the camera with the reader.
Owning Camera	The device is automatically added to the selected permission group.

Table 3- 3 Reader Parameters

3.3.4 Auxiliary Input

It is mainly used to connect to the devices, such as the infrared sensors or smog sensors.

Operation Step:

Step 1: Click **Access Device > Auxiliary Input** on the Action Menu, to access below shown interface.

Step 2: Click on Name or **Edit** to modify the parameters as shown below:

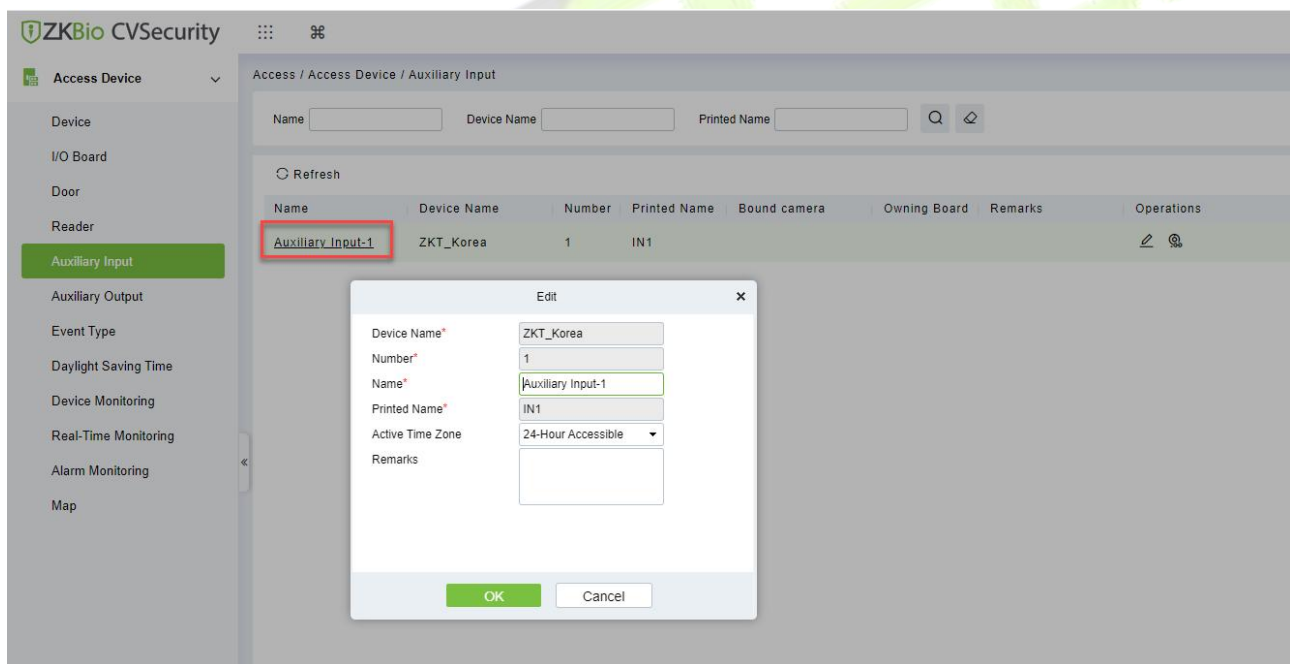

Figure 3- 21 Auxiliary input

Step 3: Click **OK** to save the name and remark and exit.

Bind/Unbind Camera:

Through this option, the reader can be connected to the cameras, and the system will make a video linkage (pop-up videos, videos or screenshots) once there is a corresponding event occurs. For this, the interaction setting in Linkage or in Global Linkage should be done before. For details, please refer to Reader: Bind/Unbind Camera.

Note: An auxiliary input point can bind more than one channel.

Parameter	How to set
Device Name	Customize the name of the device.
Name	Display the name of the device
Number	Customize the name of the device
Printed Name	Display the input number of the device.
Bound Camera	connecting the camera with the reader.
Owning Camera	The device is automatically added to the selected permission group.

Table 3- 4 Auxiliary Input Parameters

3.3.5 Auxiliary Output

It is mainly related to alarm and is used when linkage is working.

Operation Step:

Step 1: Click **Access Device > Auxiliary Output** on the Action Menu to access the following interface:

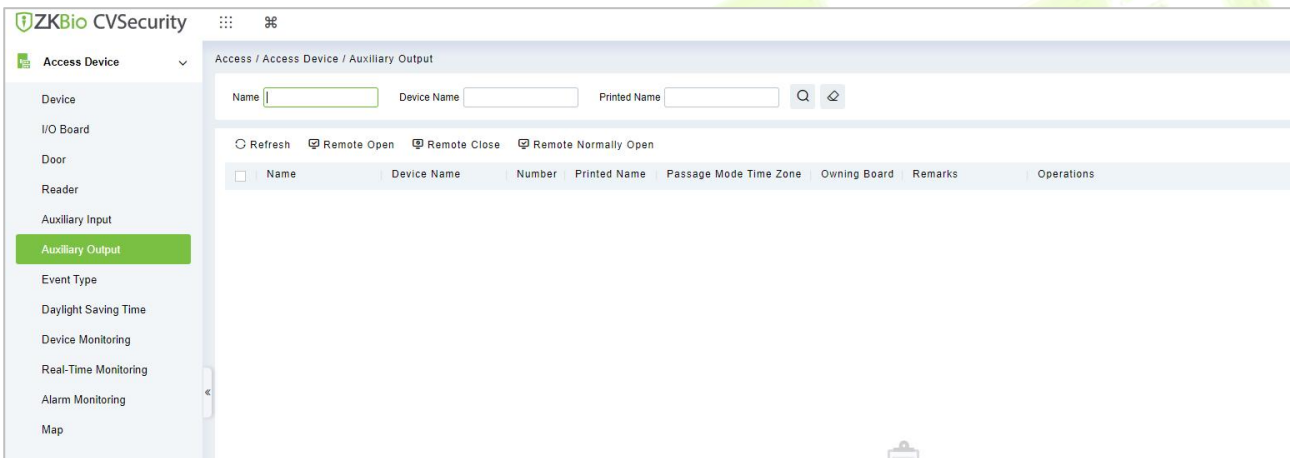

Figure 3- 22 Auxiliary Output

Step 2: Click **Edit** to modify the parameters.

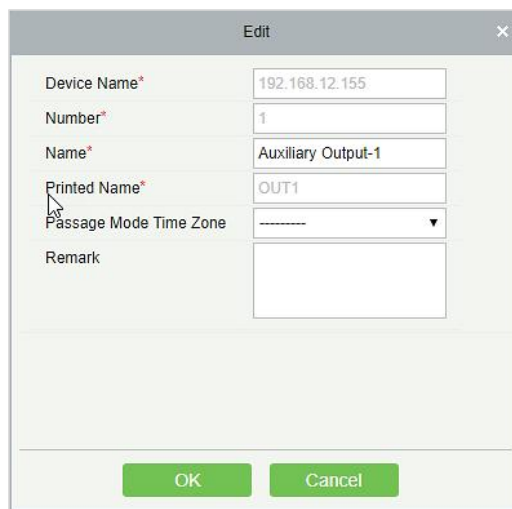

Figure 3- 23 Auxiliary Output Edit

Step 3: Click **OK** to save the name and remark and exit.

3.3.5.1 Remote Opening/Closing

It can control one door or all doors.

To control a single door, right click over it, and click **Remote Opening/ Closing** in the pop-up dialog box. To control all doors, directly click **Remote Opening/ Closing** behind Current All.

3.3.5.2 Remote Normally Open

It will set the device as normal open by remote.

Parameter	How to set
Device Name	Customize the name of the device.
Name	Display the name of the device
Number	Customize the name of the device
Printed Name	Display the input number of the device.
Bound Camera	connecting the camera with the reader.
Owning Camera	The device is automatically added to the selected permission group.

Table 3- 5 Remote Normally Open Parameter

3.3.6 Event Type

It will display the event types of the access devices.

Operation Step:

Step 1: Click **Access Device > Event** to access the following page:

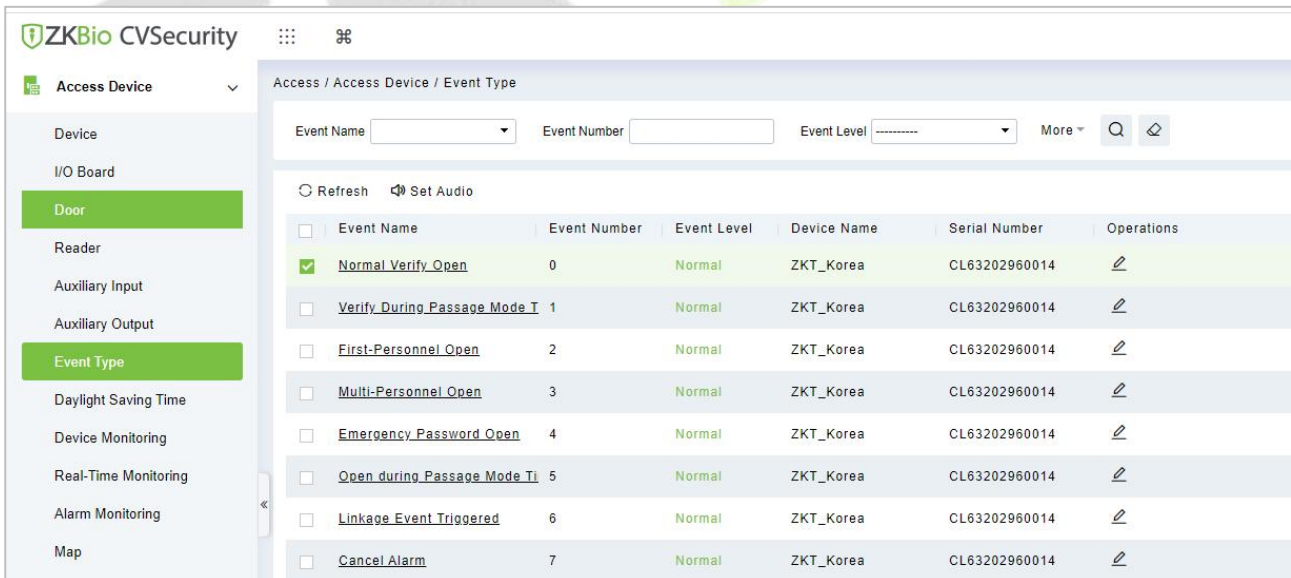

Figure 3- 24 Event Type

Step 2: Click **Edit** or click the event type name to edit.

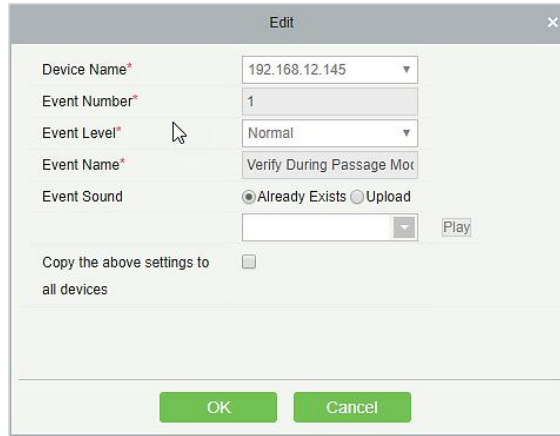

Figure 3- 25 Event Type Edit

3.3.6.1 Set Audio

Same as the event sound. Click **Set Audio**:

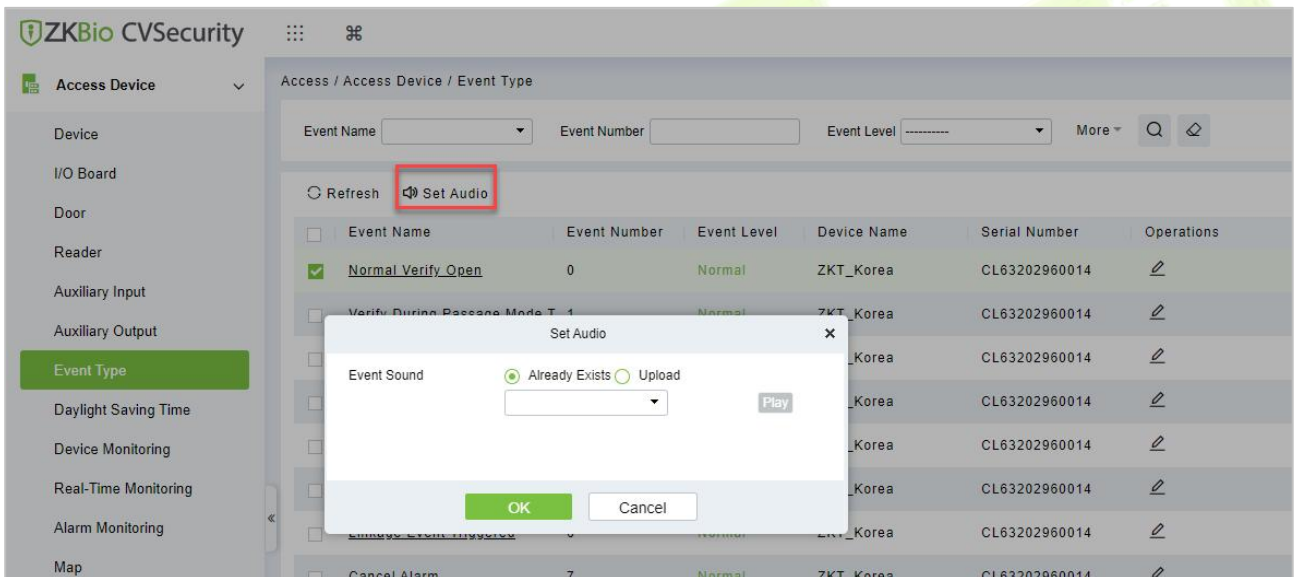

Figure 3- 26 Event Type Set Audio

You can upload an audio from your local PC. The file must be in wav or mp3 format, and it must not exceed 10MB.

Parameter	How to Set
Event Level	Normal, Exception, and Alarm are available
Event Name	Display the name of the device and it can't be modified.
Device Name:	Display the name of the device
Event Number	Display the event number of the device.
Serial Number	Display the serial number of the device

Table 3- 6 Event Parameters

3.3.7 Daylight Saving Time

DST, also called the Daylight-Saving Time, is a system to adjusting the official prescribe local time to save energy. The unified time adopted during the implementation of known as the "DST". Usually, the clocks are adjusted forward one hour in the summer to make people sleep early and get up early. It can also help to save energy. In autumn, clocks are adjusted backwards. The regulations are different in different countries. At present, nearly 70 countries adopt DST.

To meet the DST requirement, a special function can be customized. You may adjust the clock one hour forward at XX (hour) XX (day) XX (month) and one hour backward at XX (hour) XX (day) XX (month) if necessary.

3.3.7.1 Add DST (New)

Step 1: Click **Access Device > Daylight Saving Time > New.**

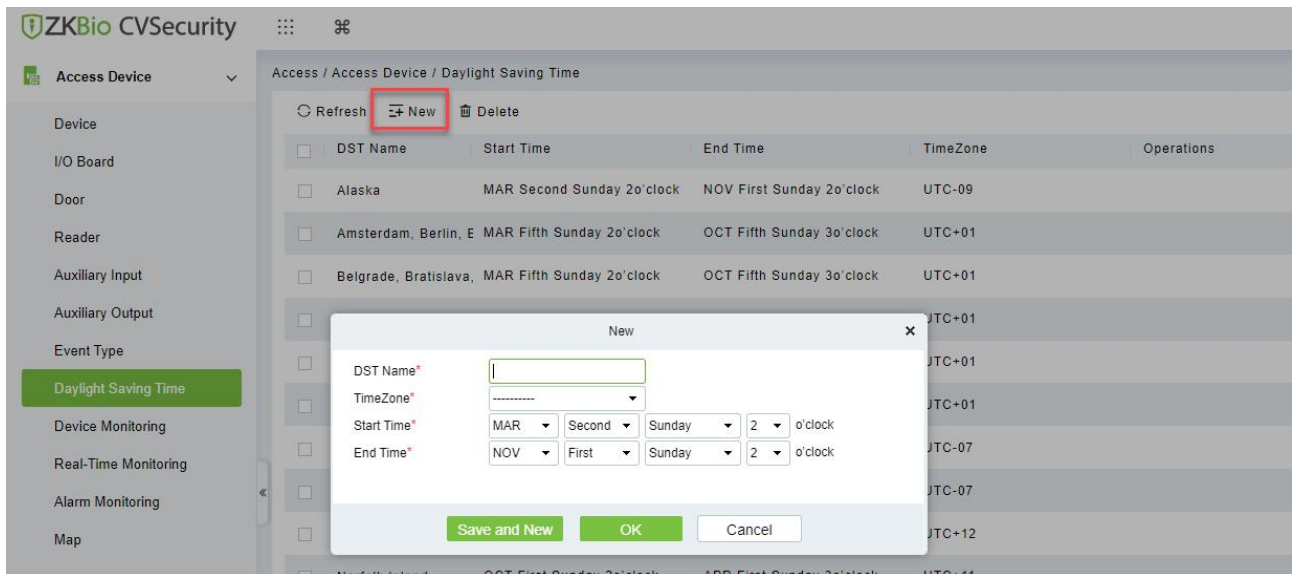

Figure 3- 27 Daylight Saving Mode

Set as "Month-Weeks-week hour: minute" format. The start time and end time is needed. For example, the start time can be set as "second Monday in March, 02:00". The system will be advanced one hour at the start time. The system will go back to the original time at the end time.

Parameter	How to set
DST Name	Display the DST name
Start Time	Display the start time of the device
End Time	Display the end time of the device
Time Zone	Display the timezone of the device.

Table 3- 7 Daylight Saving Mode Parameters

3.3.7.2 Delete

Select device, click **Delete**, and click **OK** to delete the device.

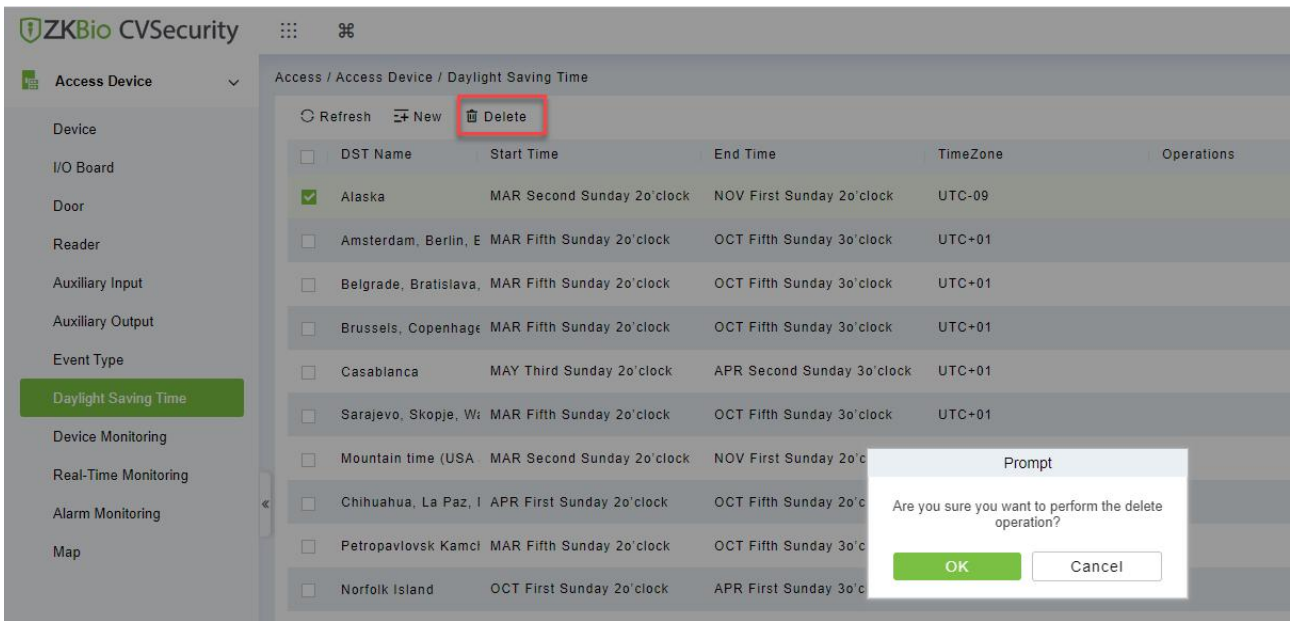

Figure 3- 28 Daylight Saving Mode Delete

3.3.8 Device Monitoring

By default, it monitors all devices within the current user’s level. You may click **Access Device > Device Monitoring** to view a list of operation information of devices: Device Name, Serial No., Area, Operation Status, Current status, Commands List, and Related Operation.

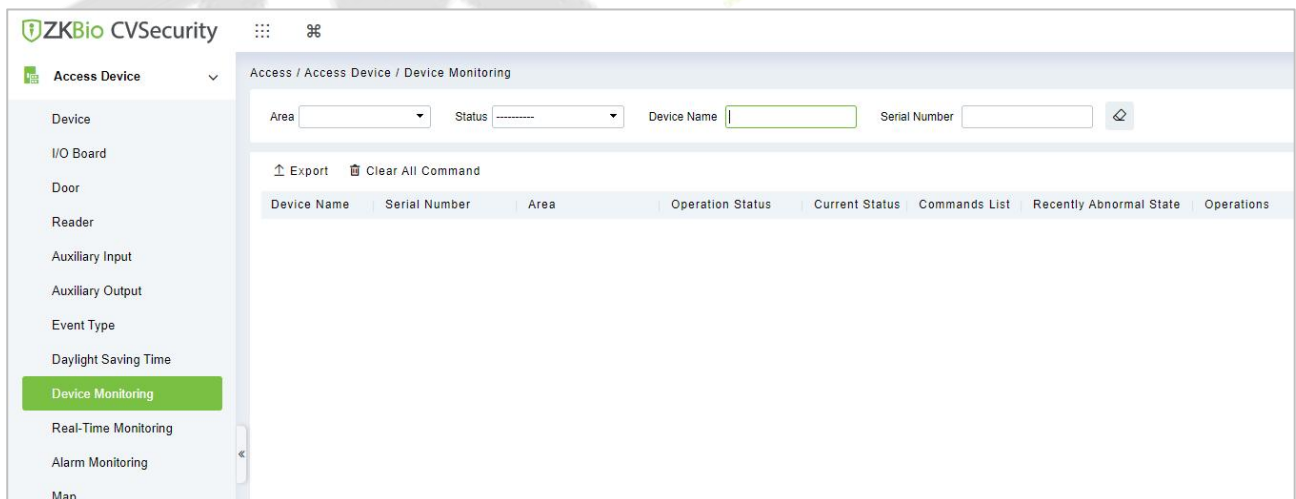
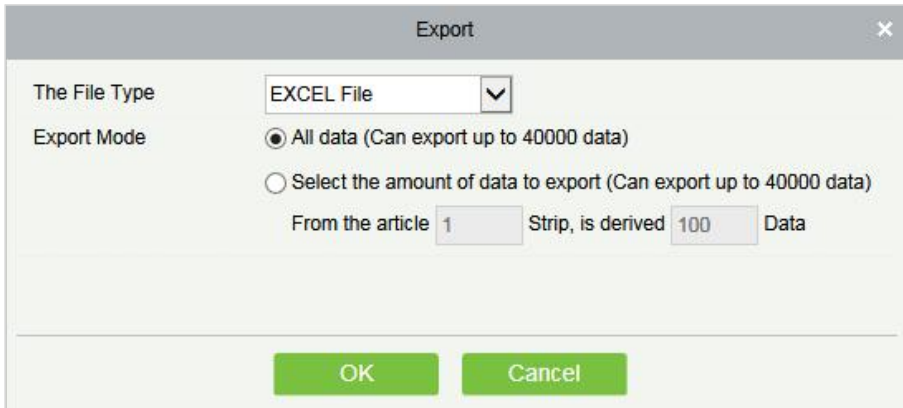

Figure 3- 29 Device monitoring

3.3.8.1 Export

Device commands can be exported in EXCEL, PDF, CSV file format.



The dialog box titled "Export" contains the following fields and options:

- The File Type:** A dropdown menu set to "EXCEL File".
- Export Mode:** Two radio buttons. The first is selected: "All data (Can export up to 40000 data)". The second is "Select the amount of data to export (Can export up to 40000 data)".
- Data Selection:** Two input fields. The first is labeled "From the article" with the value "1". The second is labeled "Strip, is derived" with the value "100".
- Buttons:** "OK" and "Cancel" buttons at the bottom.

Figure 3- 30 Export

ZKTECO Device Monitoring						
Device Name	Serial Number	Area	Operation Status	Current Status	Commands List	Recently The Abnormal State
192.168.218.60	20100501999	Area Name	Get real-time event	Normal	0	None

Figure 3- 31 Device monitoring Export

3.3.8.2 Clear All Command

You may clear the command as needed. Click **Clear Command** in operations column.

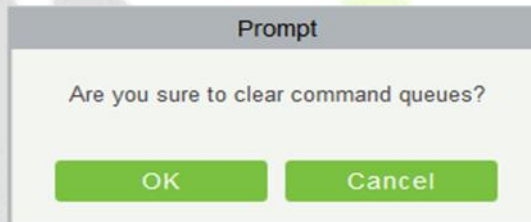

The dialog box titled "Prompt" contains the following text and buttons:

- Text:** "Are you sure to clear command queues?"
- Buttons:** "OK" and "Cancel" buttons at the bottom.

Figure 3- 32 Device monitoring Clear command

Click **OK** to clear.

Notes:

After the implementation of Clear Command, you can perform the Synchronize All Data to Devices operation on the device list to re-synchronize data in the software to the device, but this operation cannot be performed when the user capacity and fingerprint capacity are fully consumed on the device. Once the capacity is insufficient, you can replace the current device with a higher-capacity one or delete the rights of some personnel to access this device, and then perform the Synchronize All Data to Devices operation.

Operate State is the content of communications equipment of current device, mainly used for debugging.

The number of commands to be performed is greater than 0, indicating that the data is not yet synchronized to the device, so wait for the synchronization to complete.

3.3.9 Real-Time Monitoring

On the real-time management screen, the status of the added device is displayed and the device can be opened or closed. At the same time, the dynamic of real-time events is monitored. If the door opening can be verified and corresponding access control events can be generated, the access control management service configuration is complete.

Operation Step:

Step 1: Check whether the device is online.

In the **Access Control** module, choose “**Access Control Device > Real-time Monitoring**”.

Check whether the icon status of the added device is online. For details about the icon status, see Table 3-8.

Icon	State	Icon	State
	The device is disabled.		Door offline status
	No door status sensor, relay off/no relay status		Door status sensor not set, relay open/no relay state
	The door is closed and the relay is off/no relay is in online state		The door is closed and the relay is on/no relay
	On line door open, relay closed/no relay		On line door open, relay open/no relay state
	Door opens alarm, relay closes		The door opens to alarm and the relay opens
	Door opening timeout alarm, relay closed/no relay, door magnetic open		Door opening timeout alarm, relay open/no relay, door magnetic open
	Door opening timeout alarm, relay closed/door magnetic closed		Door opening timeout alarm, relay open/door magnetic close
	Door close alarm, relay off/no relay status		Door close alarm, relay open/no relay status
	No door magnetic setting, door alarm, relay closed		No door magnetic setting, door alarm, relay open
	Door opening timeout alarm, no relay/door magnetic closing		The door was locked

Note: If there is no relay status, the current firmware does not support the "Check relay Status" function.

Table 3- 8 Description of Door Types

Step 2: Remote opening/closing verification, taking remote opening as an example

Select the online door device, click "**Remote door opening**", enter the user password in the pop-up security verification, and click **OK**.

On the remote door opening screen, enter the time to open the door and tap **OK**, as shown in Figure 3-33.

If "Operation succeeded" is displayed, the remote door opening Operation is complete.

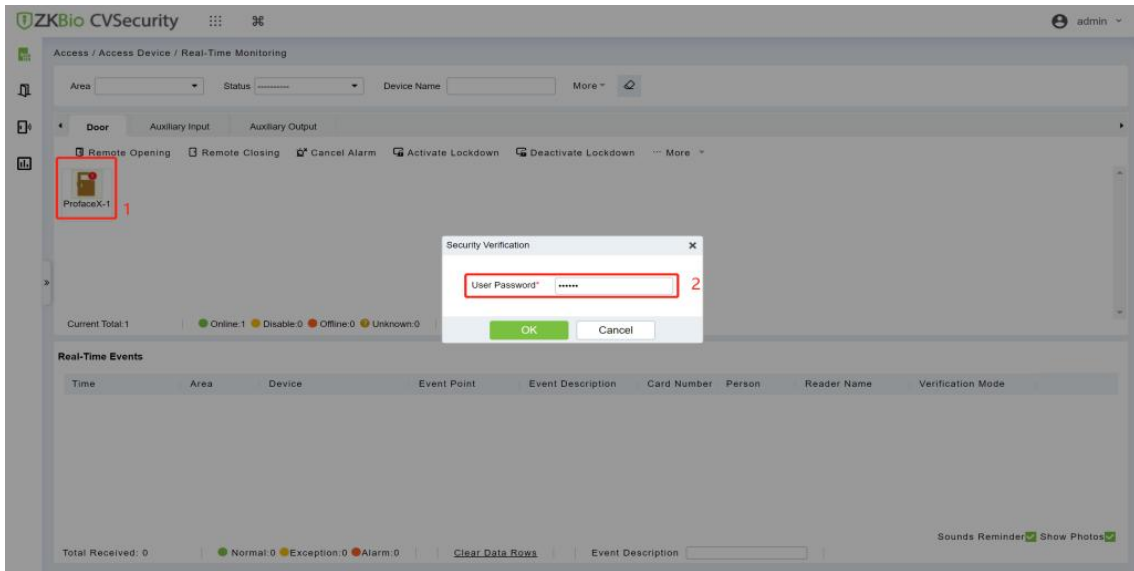

Figure 3- 33 Remote Door Opening

Step 3: Permission to verify

Verify personnel permissions on added devices.

In the real-time monitoring window, judge whether the personnel permissions are correctly configured according to the event status; If the user has been granted access rights, the real-time access event is a normal verification event, as shown in Figure 3-38, indicating that the access level service is configured

Real-Time Events									
Time	Area	Device	Event Point	Event Description	Card Number	Person	Reader Name	Verification Mode	
2021-12-16 11:15:26	Area Name	ProfaceX(CN3M212460001)	ProfaceX-1	Remote Opening			Other	Other	

Figure 3- 34 Real-Time Events

3.3.9.1 Door

● **Remote Opening/Closing**

It can control one door or all doors.

To control a single door, right click over it, and click **Remote Opening/ Closing** in the pop-up dialog box. To control all doors, directly click **Remote Opening/ Closing** behind Current All.

In remote opening, user can define the door opening duration (The default is 15s). You can select **Enable Intraday Passage Mode Time Zone** to enable the intraday door passage mode time zones, or set the door to Normal Open, then the door will not be limited to any time zones (open for 24 hours).

To close a door, select **Disable Intraday Passage Mode Time Zone** first, to avoid enabling other normal open time zones to open the door, and then select **Remote Closing**.

Note: If **Remote Opening /Closing** fails, check whether the devices are disconnected or not. If disconnected, check the network.

● **Cancel the Alarm**

Once an alarming door is displayed on the interface, the alarm sound will be played. Alarm cancellation can be done for single door and all doors. To control a single door, move the cursor over the door icon, a menu will pop-up, then click **Remote Opening/Closing** in the menu. To control all doors, directly click **Remote Opening/Closing** behind Current All.

Note: If **Cancel the alarm** fails, check if any devices are disconnected. If found disconnected, check the network.

● **Remote Normally Open**

It will set the device as normal open by remote.

● **Activate Lockdown**

It will remotely set the door status to locked status. After this, the door wouldn't receive any operations, such as card reading and remote operations. This function is supported only by certain devices. Super User Swipe to Initiate Lockdown after 3 swipes

● **Deactivate Lockdown**

It will unlock a locked door. This function is supported only by certain devices. Super User Swipe to Initiate disable after 3 swipes

● **Quick Management of Doors**

If you move the cursor to a door's icon; you can perform the above operations in a quick way. In addition, you can query the latest events from the door.

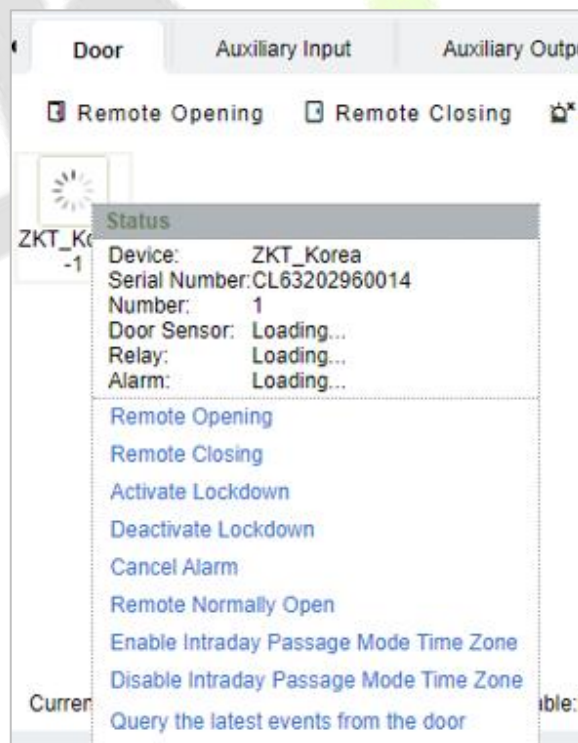

Figure 3- 35 Quick management of doors

● **Personnel Photo Display**

If a Real-Time Monitoring event contains personnel activity, the monitor will display the person photo (if no photo is registered, the monitor will display default photo). The event name, time and date are

displayed.

- **Play Audio**

If this option is selected, it plays an audio after an alarming event occurs.

- **Query the Latest Events from The Door**

Click to quickly view the latest events happened on the door.

- **Issue Card to Person**

If you swap an unregistered card, a record with a card number will pop-up in real-time monitoring interface. Right click that card number, and a menu will pop-out. Click "Issue card to person", to assign that card to one person.

Event Monitoring:

The system will automatically acquire records of devices being monitored (by default, display 200 records), including normal and abnormal access control events (including alarm events). Normal events will appear in green; alarm events will appear in red; other abnormal events will appear in orange.

The Superuser can initiate lockdown after 3 swipes and deactivate the same after 3 swipes.

3.3.9.2 Auxiliary Input

It monitors current auxiliary input events in real-time.

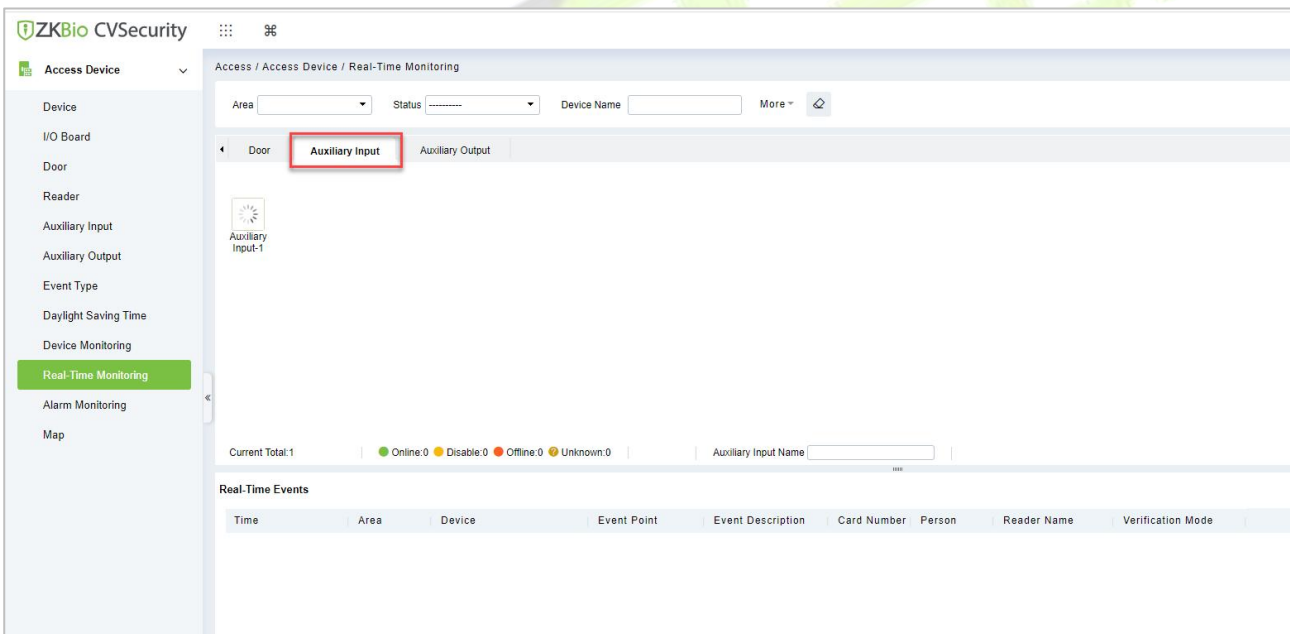

Figure 3- 36 Real Time Monitoring Auxiliary Input

3.3.9.3 Auxiliary Output

Here you can perform Remote open, Remote Close, Remote Normally Open.

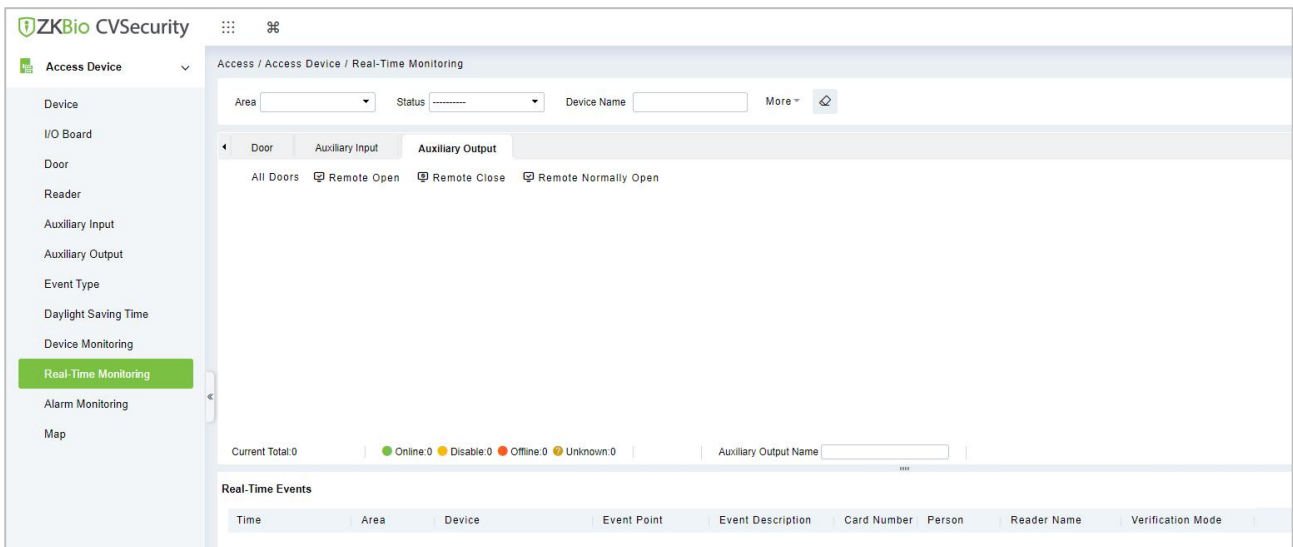

Figure 3- 37 Real Time Monitoring Auxiliary Output

- **Monitoring All**

By default, the home page displays all doors of the panels within the user's level. User may monitor door(s) by setting the Area, Access Control or Door.

3.3.10 Alarm Monitoring

It will monitor the status and real-time events of doors under the access control panels in the system in real-time, including normal events and abnormal events

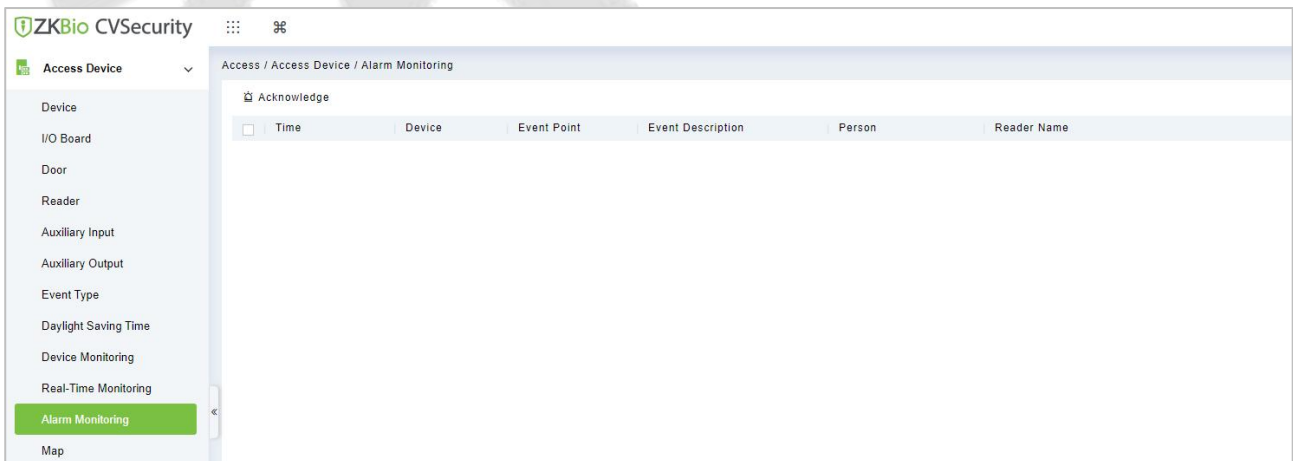

Figure 3- 38 Alarm Monitoring

3.3.11 Map

Click **Access Device > Map > New** to add a map.

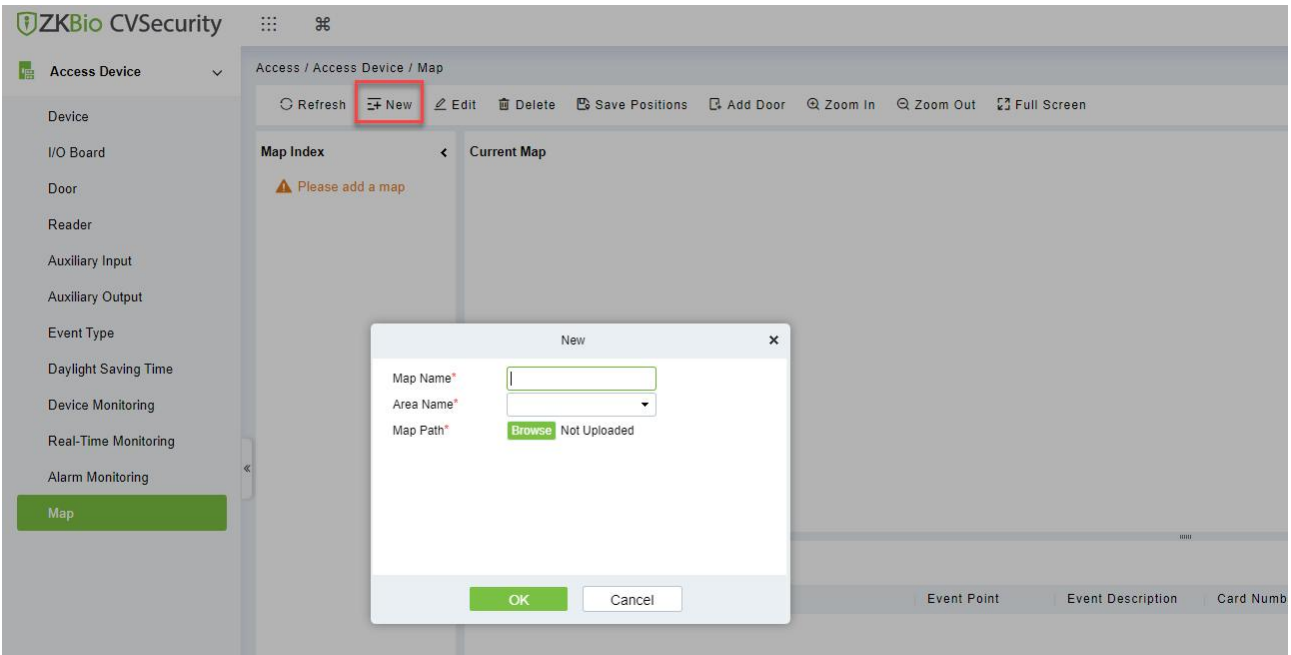

Figure 3- 39 Map

After adding, users can add door on the map, perform zoom-in, zoom-out, etc. If users relocated or modified the map, click **Save Positions** to save. The user can view the new setting at next visit.

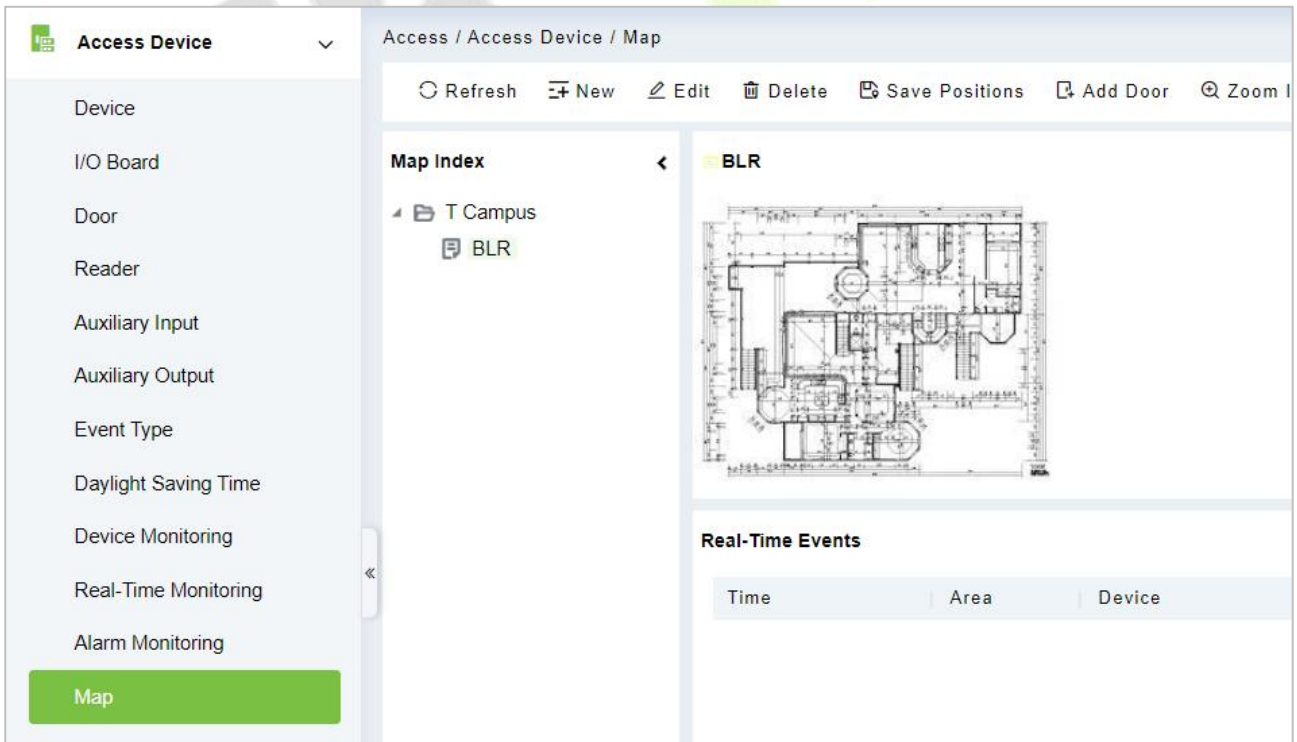

Figure 3- 40 Map Position

3.3.11.1 Add/Delete Map

Users can add or delete a map as needed.

3.3.11.2 Edit Map

Users can edit map name, change map or the area it belongs to.

- **Adjust Map (includes door)**

Users can add a door on the map or delete an existing one (right click the door icon, and select **Delete Door**), or adjust the map or position(s) of the door or camera icons (by dragging the door or camera icons), adjust the size of the map (click **Zoom in** or **Zoom out** or click **Full Screen**).

- **Add Doors & Cameras**

After adding the map, click on "Add doors" and "Add cams" in the toolbar on the right to select devices to add to the map.

- **Door Operation**

If you move the cursor to a door, the system will automatically filter and displays the operation according to the door status. Users can do remotely open/close doors, cancel alarms, etc.

- **Levels Control**

Users need to select the relevant area for the map when adding levels. The area will be relevant to the user access levels, users can only view or manage the map within levels. If the relevant area of a map is modified, all doors on the map will be cleared. Users need to add the doors manually again.

When an administrator is adding a new user, he can set the user operation rights in role setting, such as Save positions, Add Door, Add Camera, etc.

Note:

In map modification, users can choose to modify the map name but not the path. Users only need to check the box to activate the modification option.

The system supports adding multi doors at the same time. After adding the doors, users need to set the door position on the map and click **Save**.

When modifying door icon, especially when users zoomed out the map, the margin for top and left shall not be smaller than 5 pixels, or system will prompt error.

Users are recommended to add a map size under 1120 * 380 pixels. If several clients access the same server, the display effect will be different according to resolutions of screen and the settings of browsers.

3.4 Access Rule

Access control rules are the core logic control part of access control, including time period settings, linkage settings, etc.

3.4.1 Timezone

In **Access Control** Module, time period is a very important basic concept, which is used to set the use time of the door and specify that **Access Control** is available in the valid time period.

This section describes how to configure Step to manually add a time range in ZKBio CVSecurity.

3.4.1.1 Add (New)

Operation Step:

Step 1: In the access **Control** module, choose “**Access Rule > Time zone**”.

Step 2: Click **New**, the interface for adding time segments is displayed.

Step 3: The time segment page is added. Set the content based on the new requirements, as shown in Figure 3-41. For parameter Settings, see Table 3-9.

Date	Time	Interval 1		Interval 2		Interval 3	
		Start Time	End Time	Start Time	End Time	Start Time	End Time
Monday		00 : 00	00 : 00	00 : 00	00 : 00	00 : 00	00 : 00
Tuesday		00 : 00	00 : 00	00 : 00	00 : 00	00 : 00	00 : 00
Wednesday		00 : 00	00 : 00	00 : 00	00 : 00	00 : 00	00 : 00
Thursday		00 : 00	00 : 00	00 : 00	00 : 00	00 : 00	00 : 00
Friday		00 : 00	00 : 00	00 : 00	00 : 00	00 : 00	00 : 00
Saturday		00 : 00	00 : 00	00 : 00	00 : 00	00 : 00	00 : 00
Sunday		00 : 00	00 : 00	00 : 00	00 : 00	00 : 00	00 : 00
Holiday Type 1		00 : 00	00 : 00	00 : 00	00 : 00	00 : 00	00 : 00
Holiday Type 2		00 : 00	00 : 00	00 : 00	00 : 00	00 : 00	00 : 00
Holiday Type 3		00 : 00	00 : 00	00 : 00	00 : 00	00 : 00	00 : 00

Figure 3- 41 Adding A Time Range

Parameter	How to set up
Schedule Name	You can set a time range name for easy memory.
Note	Remarks Description of user-defined Settings.
Time interval	Set the start time and end time for each time range. The time period includes one week and three holiday-type time periods.
Copy Monday's time to other weekdays	You can quickly copy your Monday Settings to other weekdays.

Table 3- 9 Parameters to Be Added in The Time Range

Step 4: Click **OK** to finish adding the time range.

3.4.1.2 Delete

Select time zone name, click **Delete**, and click **OK** to delete the time zone.

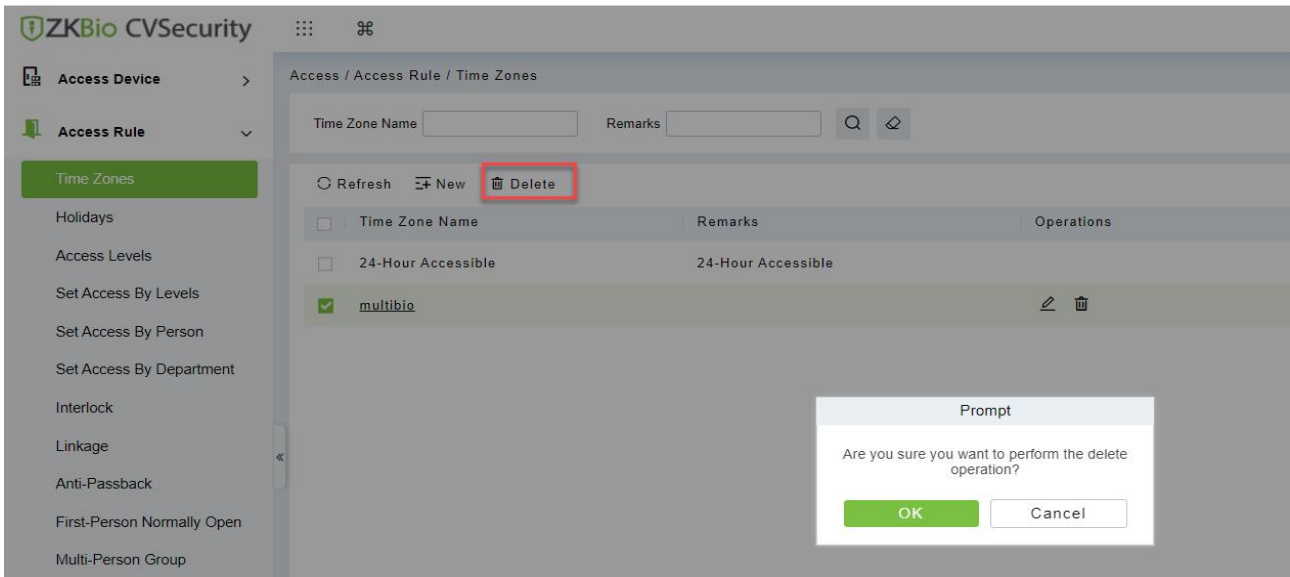

Figure 3-42 Time Zone Delete

3.4.2 Holiday

The access control time on holidays may be different from that on weekdays. To facilitate Operation, the system supports separate access control time on holidays.

This section describes how to manually add a holiday Step in ZKBio CVSecurity.

3.4.2.1 Add (New)

Operation Step:

Step 1: In the **Access Control** module, choose “**Access Rule > Holidays**”.

Step 2: Click **New**, the page for adding holidays is displayed.

Step 3: When a page is added during holidays, set the content as required, as shown in Figure 3-43. For parameter Settings, see Table 3-10.

Figure 3-43 Adding Holidays

Parameter	How to set up
Holiday Name	You can set holiday names for easy memory.
Type of Holidays	The holiday type can be: Holiday type 1, Holiday type 2, holiday type 3. Set holiday type to time Range.
Start time/End time	Set the holiday time range.
According to the annual circulation	Set whether this holiday cycle by year: yes, no. For example, if New Year’s Day is January 1, set this parameter to Yes.Mother’s Day falls on the second Sunday in May. If the date is uncertain, set it to No.
Note	Custom Settings description.

Table 3- 10 Parameters for Adding Holidays

Step 4: Click **OK** to finish adding the holiday.

3.4.2.2 Delete

Select holiday, click **Delete**, and click **OK** to delete the holiday.

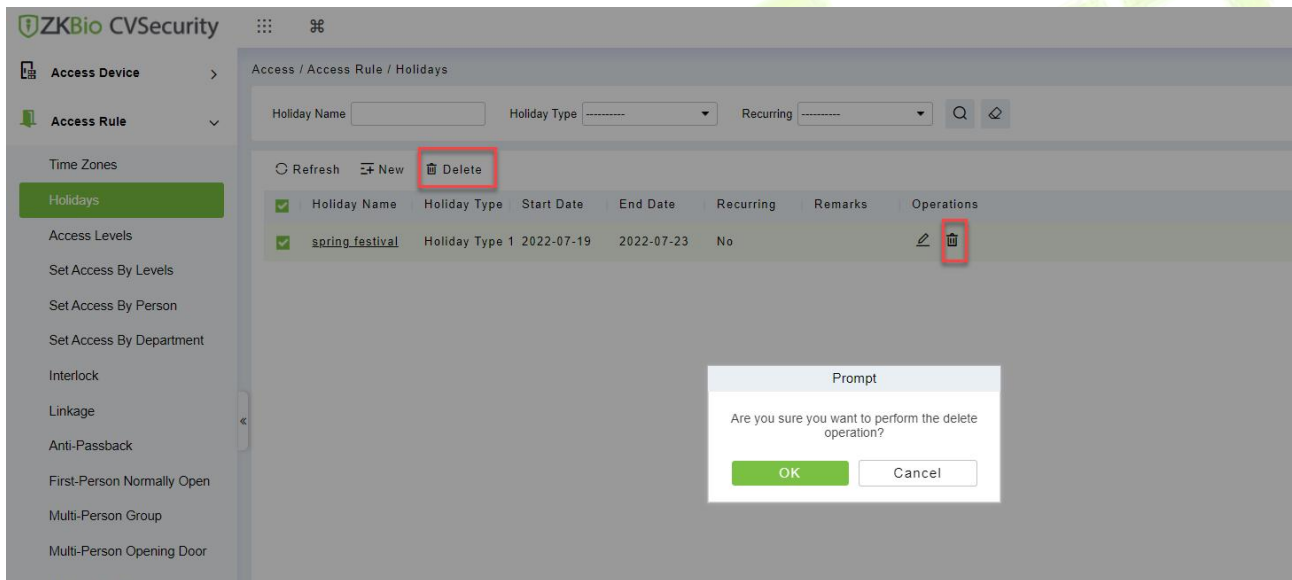

Figure 3- 44 Holiday Delete

3.4.3 Access Level

Access level groups define groups and categories of internal doors to facilitate subsequent permission assignment operations.

Setting operations include creating access level groups and adding doors to access level groups.

3.4.3.1 Add (New)

This section describes how to create Step for Access Control groups in ZKBio CVSecurity.

Operation Step:

Step 1: In the **Access Control** module, choose **“Access Rule > Access Level”**.

Step 2: Click **New** in the left column, and the page for adding access level groups is displayed.

Step 3: On the page for adding access level groups, set parameters based on the new requirements, as shown in Figure 3-45. For parameter Settings, see Table 3-11.

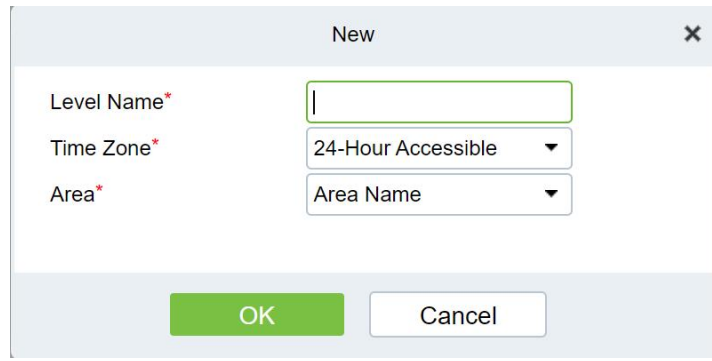

Figure 3- 45 Adding Access Level Groups

Parameter	How to set up
Permission Group Name	You can customize the name of the access level group for easy query.
Access Control Period	Select the configured access time range to define the valid access time range for this permission group.
Area	Select the configured area from System > System Management > Area Settings and define the area to which the Access Control group belongs.

Table 3- 11 Description of Access Control Right Groups

Step 4: Click **OK** to finish configuring the access control right group.

3.4.3.2 Add Door

This topic describes how to add Operation Step to the door of the created access level group in ZKBio CVSecurity.

Operation Step:

Step 1: In the **Access Control** module, choose **“Access Rule > Access level>Add Door”**.

Step 2: Click **“Add Door”**, and the page for selecting a door is displayed. add a door as required, as shown in Figure 3-46.

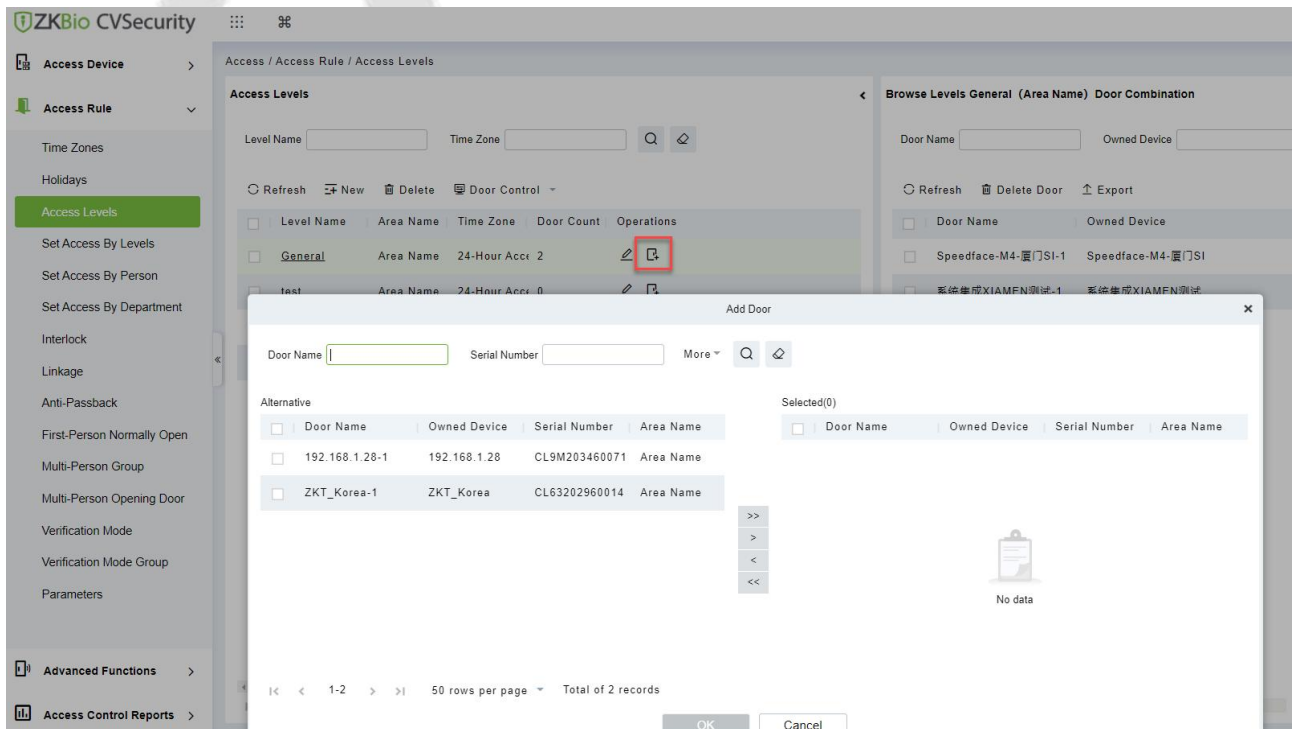

Figure 3- 46 Adding Access Level Groups Add Doors

Step 3: Click **OK** to finish configuring the door for the access control right group.

3.4.3.3 Door Control

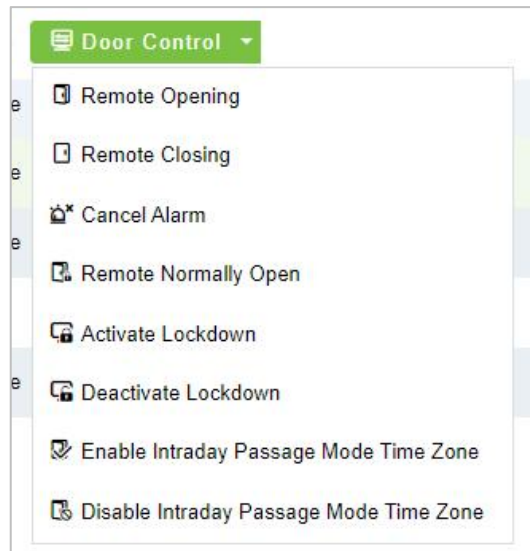

Figure 3- 47 Door Control

- **Remote Opening/Closing**

It can control one door or all doors.

To control a single door, right click over it, and click **Remote Opening/ Closing** in the pop-up dialog box. To control all doors, directly click **Remote Opening/Closing** behind Current All.

In remote opening, user can define the door opening duration (The default is 15s). You can select **Enable Intraday Passage Mode Time Zone** to enable the intraday door passage mode time zones, or set the door to Normal Open, then the door will not be limited to any time zones (open for 24 hours).

To close a door, select **Disable Intraday Passage Mode Time Zone** first, to avoid enabling other normal open time zones to open the door, and then select **Remote Closing**.

Note: If **Remote Opening/Closing** fails, check whether the devices are disconnected or not. If disconnected, check the network.

- **Cancel the Alarm**

Once an alarming door is displayed on the interface, the alarm sound will be played. Alarm cancellation can be done for single door and all doors. To control a single door, move the cursor over the door icon, a menu will pop-up, then click **Remote Opening/Closing** in the menu. To control all doors, directly click **Remote Opening/Closing** behind Current All.

Note: If **cancel the alarm** fails, check if any devices are disconnected. If found disconnected, check the network.

- **Remote Normally Open**

It will set the device as normal open by remote.

- **Activate Lockdown**

It will remotely set the door status to locked status. After this, the door wouldn't receive any operations, such as card reading and remote operations. This function is supported only by certain devices. Super User Swipe to Initiate Lockdown after 3 swipes

● **Deactivate Lockdown**

It will unlock a locked door. This function is supported only by certain devices. Super User Swipe to Initiate disable after 3 swipes.

3.4.3.4 Import or Export Access Level

Step 1: Export and fill in Access Level Template:

In the **Access Module**, click **Access Rule > Access Levels > Export > Export Access Level**, then fill in the Access levels information.

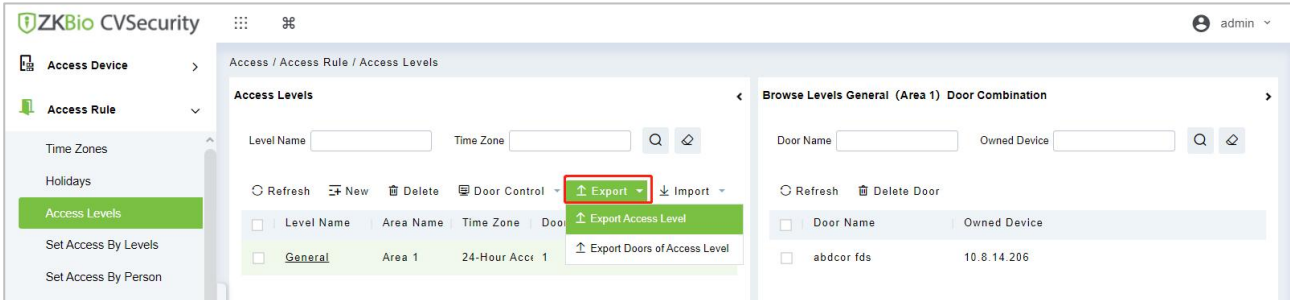

Figure 3- 48 Export Access Level Template

Access Levels		
Level Name	Area Name	Time Zone
Level 1	Area 1	Time Zone 1
Level 2	Area 2	Time Zone 1
Level 3	Area 3	Time Zone 1
Level 4	Area 4	Time Zone 1
Level 5	Area 5	Time Zone 1

Figure 3- 49 Fill in Access Level Template

Note: The Level name can be customized. The Area Name can be set from **System > System Management > Area Settings**, the Time Zone can be set from **Access > Access Rule > Time Zones**.

Step 2: Export the Doors of Access Level Template:

In the **Access Module**, click **Access Rule > Access Levels > Export > Export Doors of Access Level**, then You can export doors of access level in Excel file format.

Enter the user password in the displayed security verification dialog box, and Click **OK**. Select whether to encrypt the file and the file format to export, and Click **OK**.

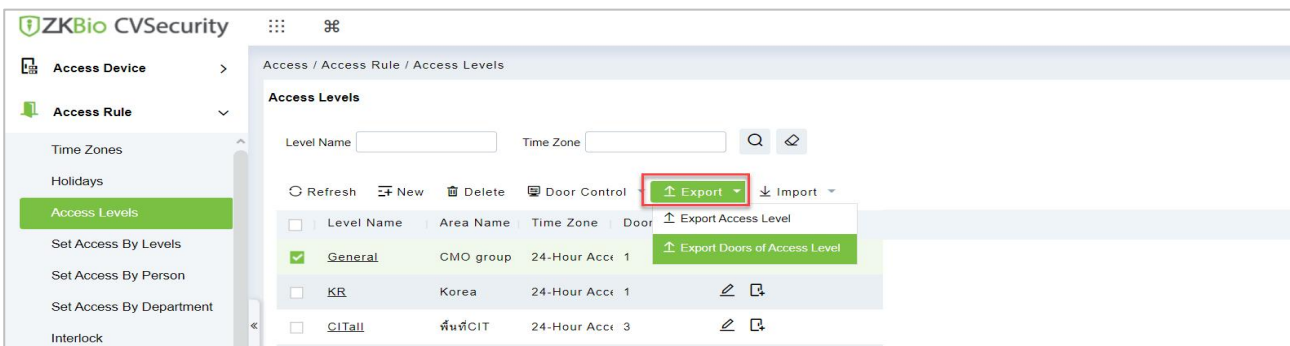

Figure 3- 50 Export the Access Level Template 1

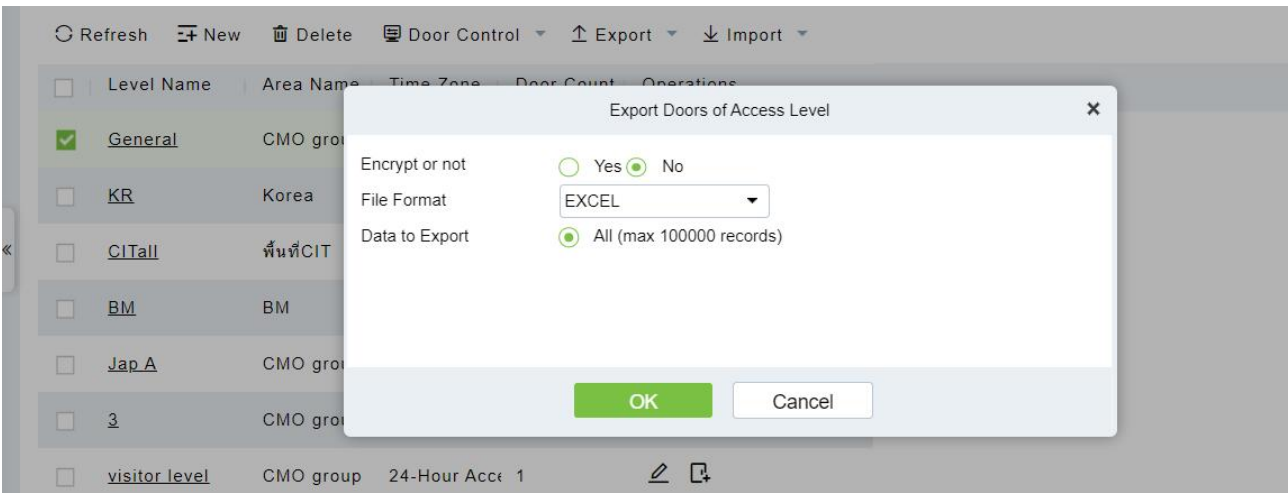

Figure 3- 51 Export the Access Level Template 2

Step 3: Import the Access Level Template:

In the **Access** module, click **Access Rule > Access Levels > Import > Import Access Level**, and click **Browser** to upload the Access Level Template.

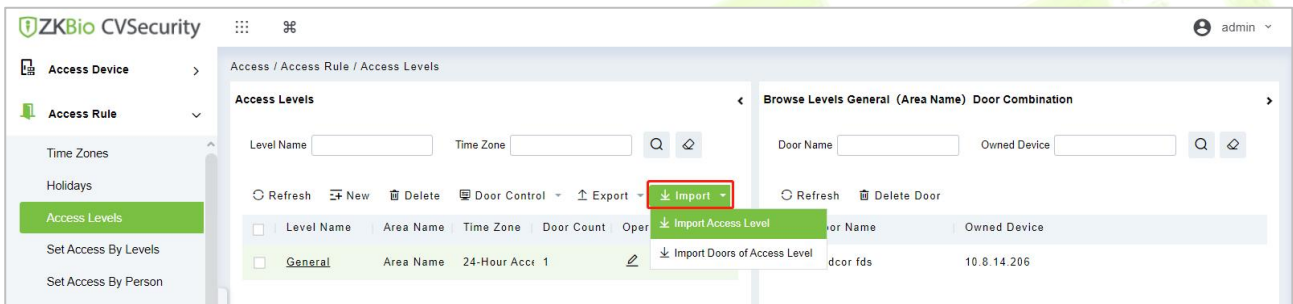

Figure 3- 52 Import the Access Level Template 1

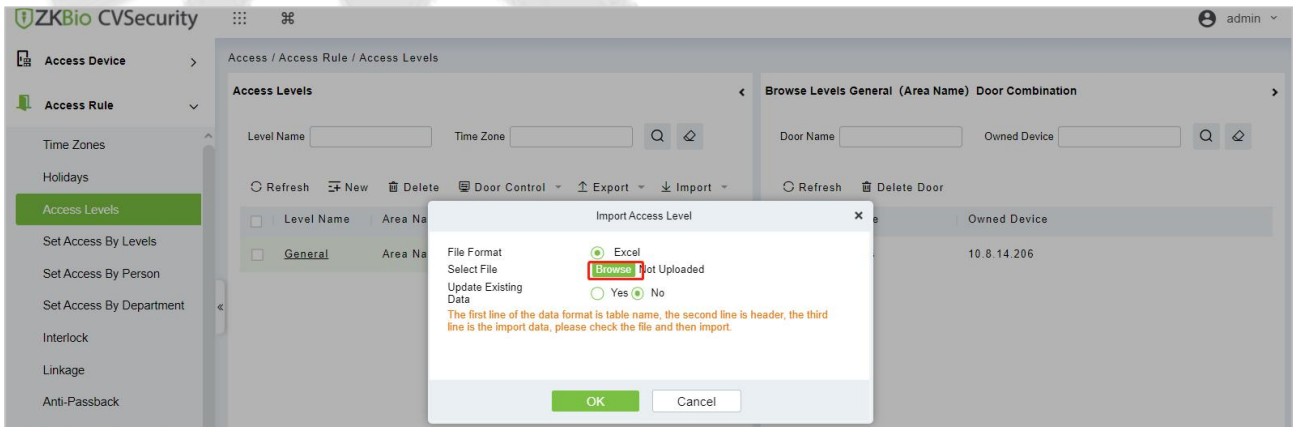

Figure 3- 53 Import the Access Level Template 2

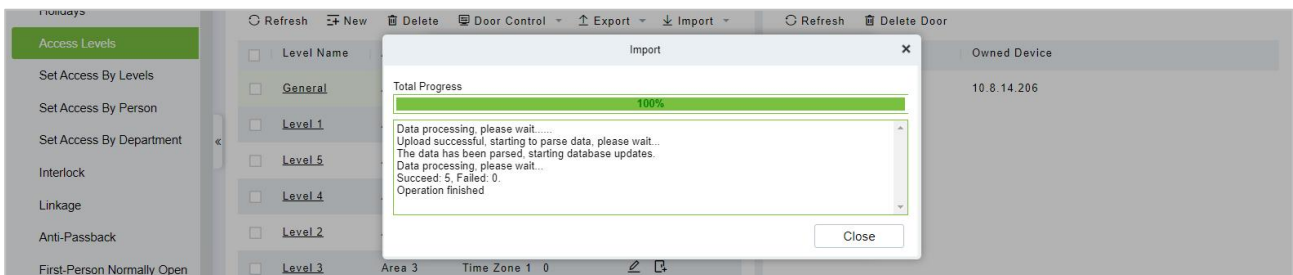

Figure 3- 54 Import the Access Level Template 3

Step 4: After the upload is successful, we can view the uploaded level as the following figure.

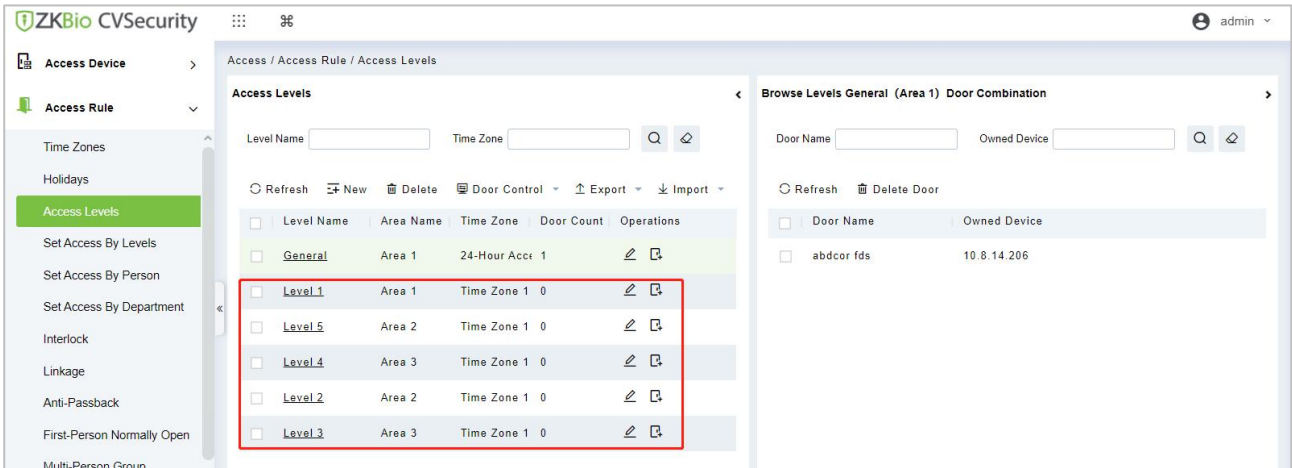

Figure 3-55 Import the Access Level Template 4

Step 5: Import the Doors of Access Level Template:

In the **Access** module, click **Access Rule > Access Levels > Import > Import Doors of Access Level**, and click **Browser** to upload the Access Level Template.

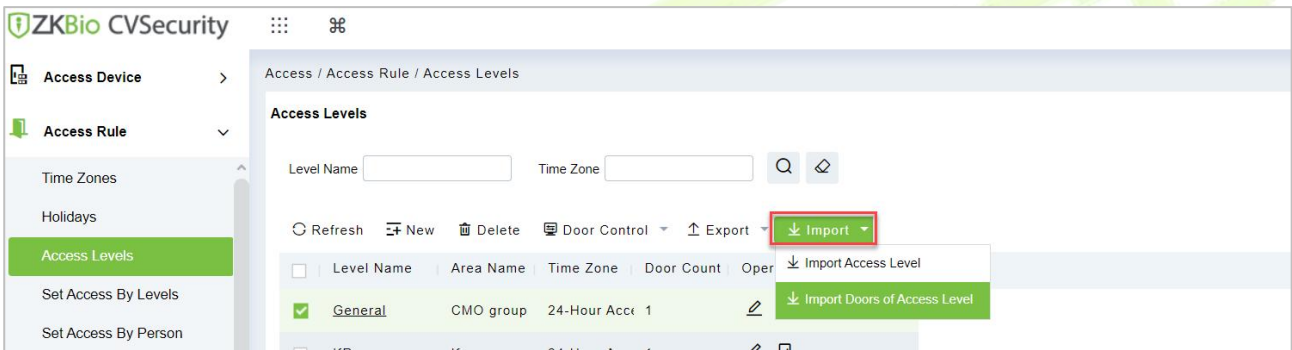

Figure 3-56 Import the Doors of Access Level Template 1

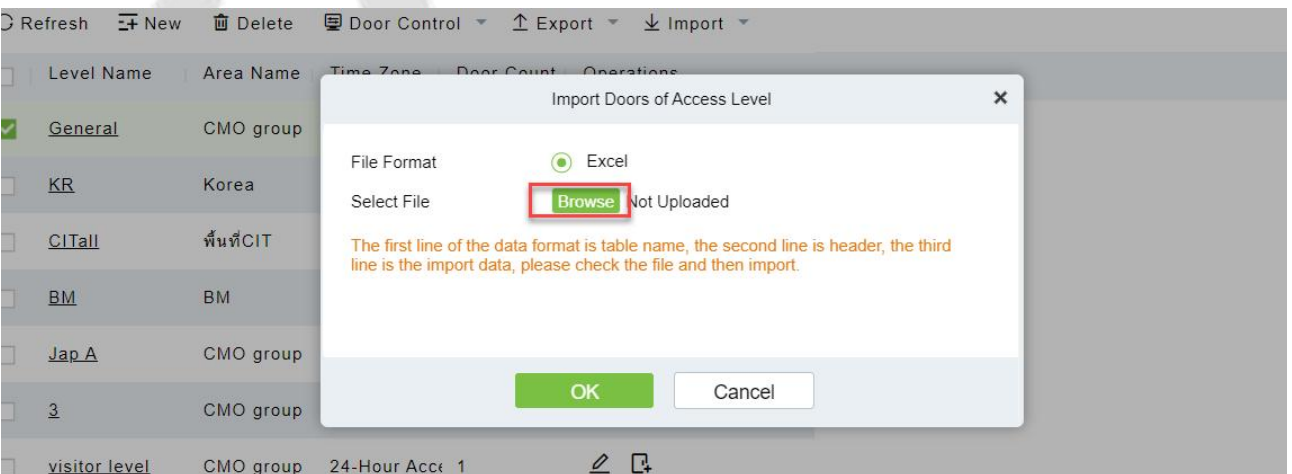

Figure 3-57 Import the Doors of Access Level Template 2

Step 6: After the upload is successful, we can view the uploaded level as the following figure.

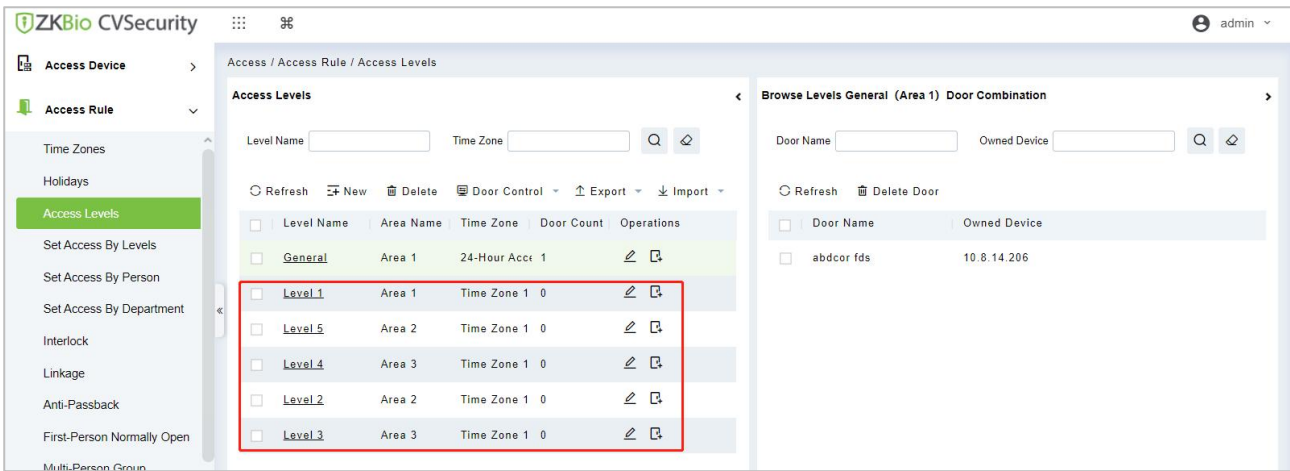

Figure 3- 58 Import the Doors of Access Level Template 3

3.4.4 Set Access Level Allocation

Permission assignment Manages the access level of personnel. After permission assignment, personnel can verify the door opening Operation.

You can assign user rights by user group or assign user rights by user group.

3.4.4.1 Assign Personnel Rights by Permission Group

Assigning personnel permissions by permission group is used to define a set of open-door personnel for a permission group.

Describes Operation Step that assigns staff permissions by permission group in ZKBio CVSecurity.

Operation Step:

Step 1: In the **Access Control** module, choose **“Access Rule>Set Access by Levels”**.

Step 2: In the Operation column of the corresponding permission group, tap **“Add Personnel”**. The Add personnel page is displayed. Select personnel as required, as shown in Figure 3-48.

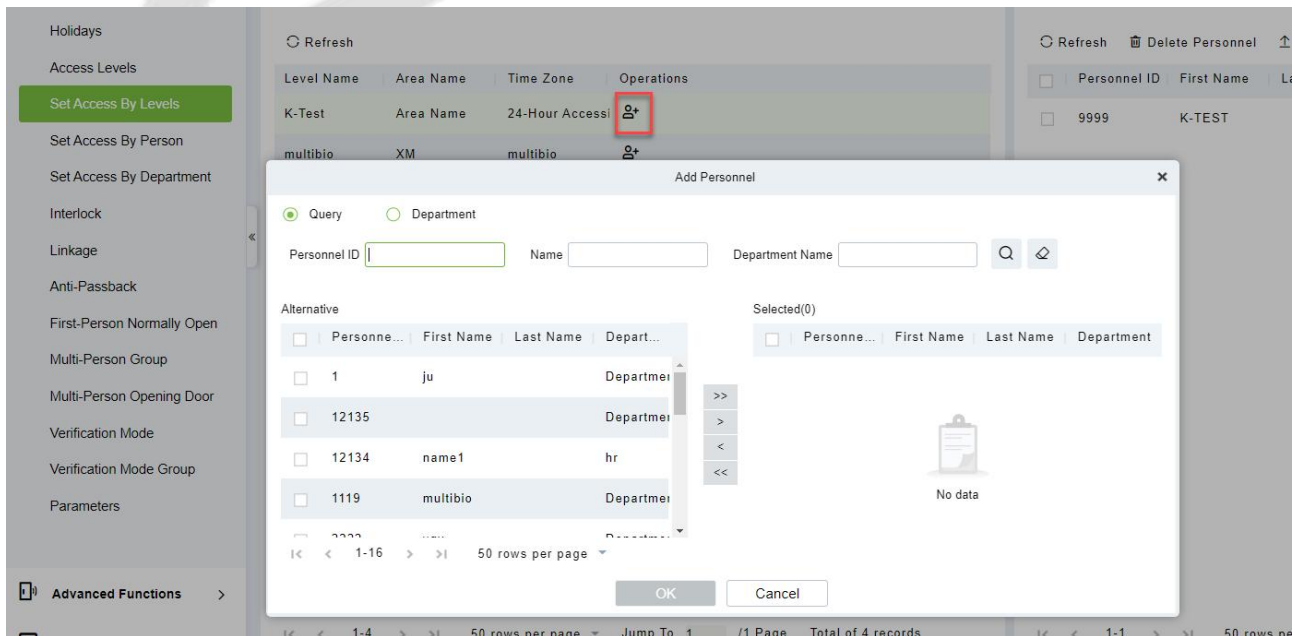

Figure 3- 59 Assigning Rights to Users by Rights Group

Step 3: Click **OK** to complete the assignment of personnel permissions.

3.4.4.2 Delete Personnel

Select personnel ID, click **Delete**, and click **OK** to delete the personnel ID.

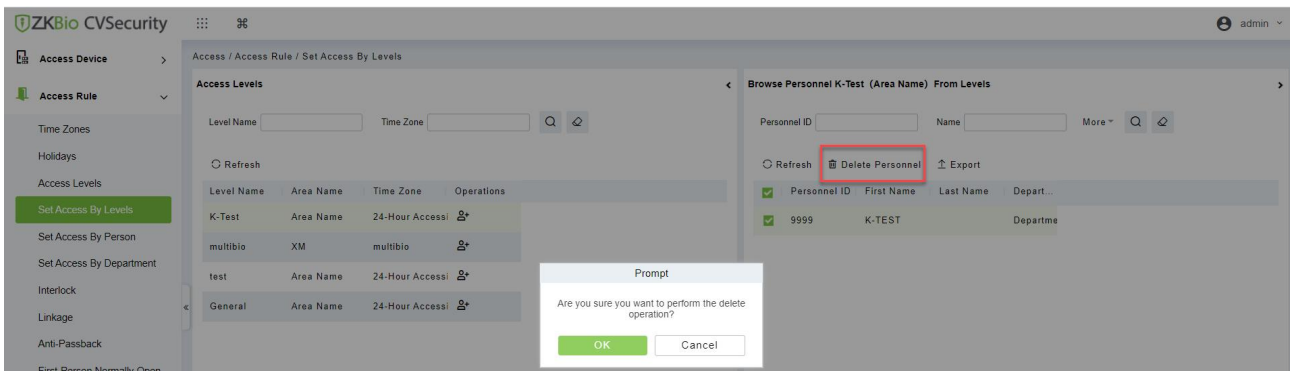

Figure 3- 60 Delete Personnel

3.4.4.3 Export

Device information can be exported in EXCEL, PDF, CSV file format.

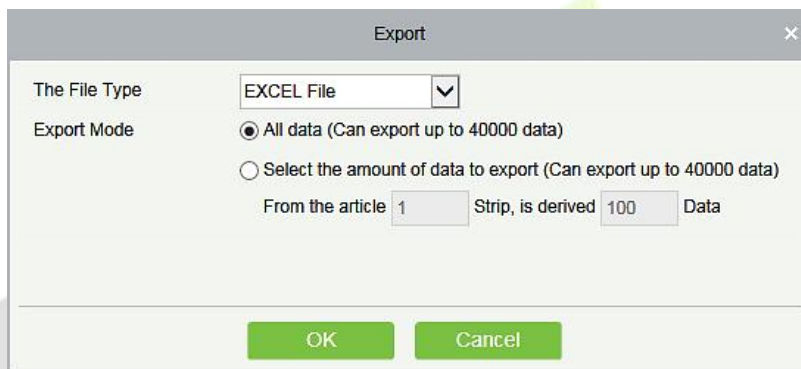

Figure 3- 61 Export

ZKTECO Device										
Device Name	Serial Number	Area Name	Communication Type	Network Connection Mode	IP Address	RS485 Parameter	Enable	Device Model	Register device	Firmware Version
192.168.218.60	20100501999	Area Name	HTTP	Wired	192.168.218.60		Enable	C3-400Pro		AC Ver 4.7.7.3033 Jun 16 2017

Figure 3- 62 Set Access level Allocation Export

3.4.5 Set Access Level Groups by Person

Assigning access level groups by person A permission set is used to define the access level set of a person.

This section describes Operation Step that assigns access control group permissions by person in ZKBio CVSecurity.

3.4.5.1 Access Control Setting

Operation Step:

Step 1: In the **Access Control** module, choose "**Access Control > Settings by Personnel**".

Step 2: In the Operation column of the Access Control group, click "**Add Access Control Group**". The page for adding access control groups is displayed. Select the Access Control group as required.

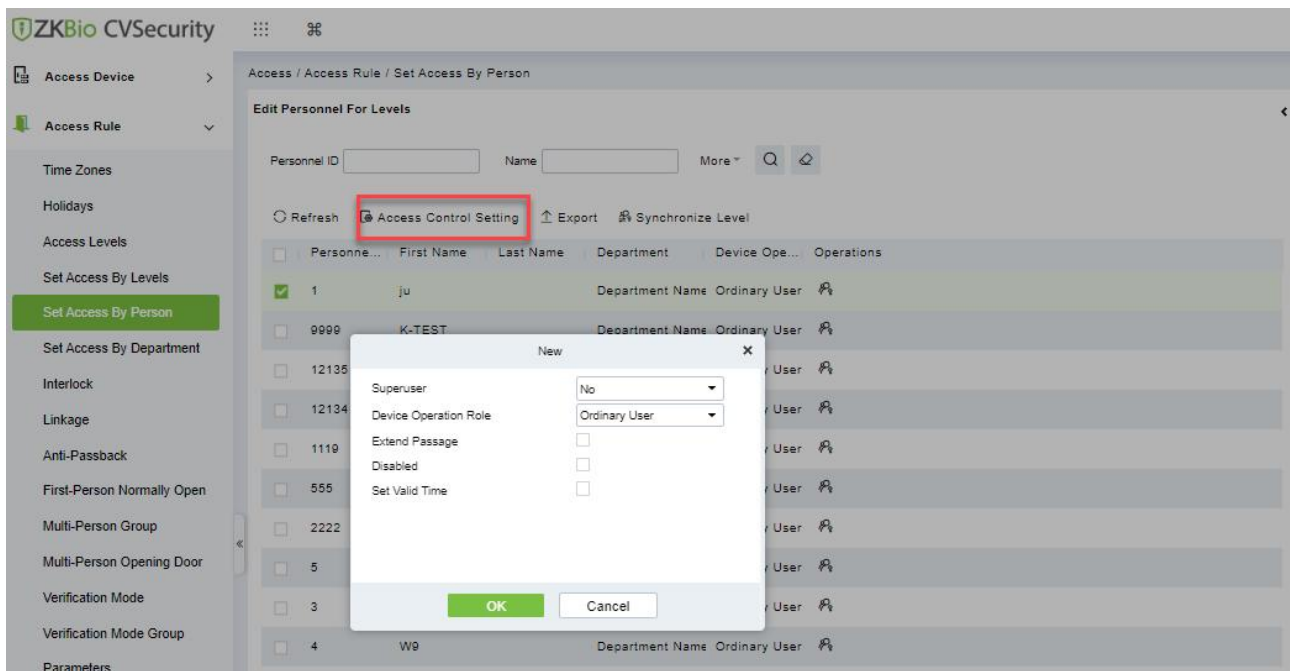

Figure 3- 63 Assigning Rights Groups by User

Step 3: Click **OK** to complete the assignment of personnel permissions.

3.4.5.2 Add Level

Permission assignment Manages the access level of personnel. After permission assignment, personnel can verify the door opening Operation.

You can assign user rights by user group or assign user rights by user group.

- **Assign Personnel Rights by Permission Level**

Assigning personnel permissions by permission group is used to define a set of open-door personnel for a permission group.

Describes Operation Step that assigns staff permissions by permission group in ZKBio CVSecurity.

Operation Step:

Step 1: In the **Access Control** module, choose "**Access Rule>Set Access by Levels** "

Step 2: In the Operation column of the corresponding permission group, tap "**Add Levels**". The Add level page is displayed. Select personnel as required.

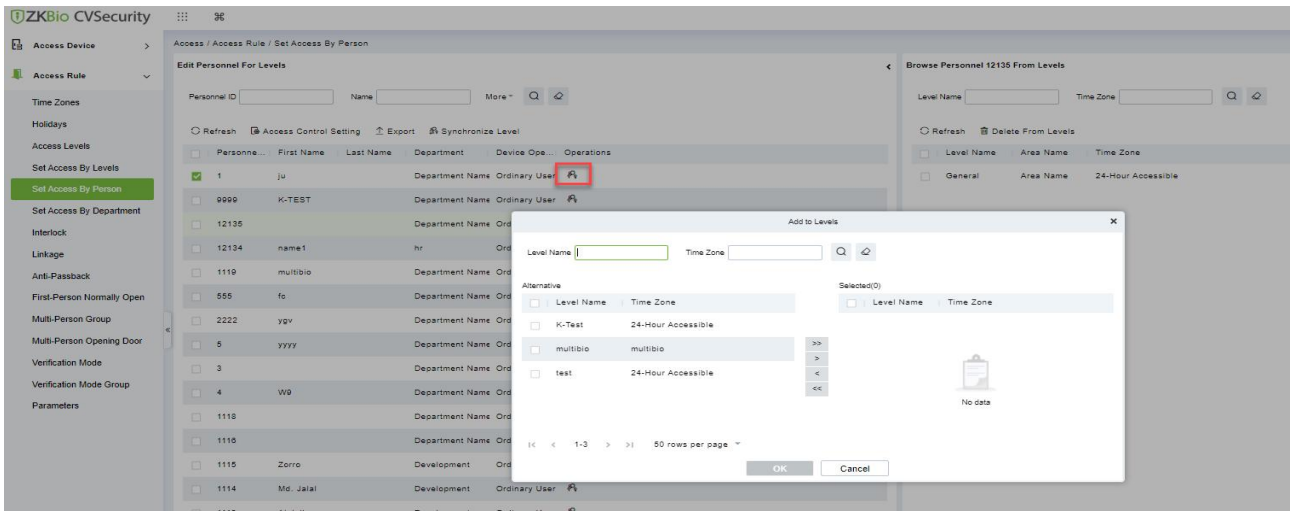

Figure 3- 64 Assigning Rights to Users by Rights Group

Step 3: Click **OK** to complete the assignment of level permissions.

3.4.5.3 Delete from Level

Select level name, click **Delete**, and click **OK** to delete the level name.

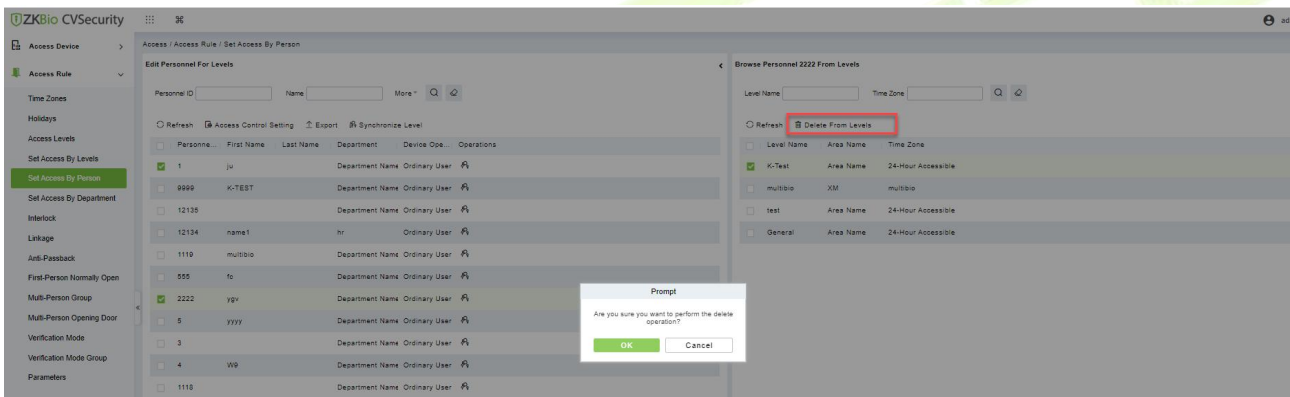

Figure 3- 65 Access Level Group by Person Delete

3.4.5.4 Export

Device information can be exported in EXCEL, PDF, CSV file format.

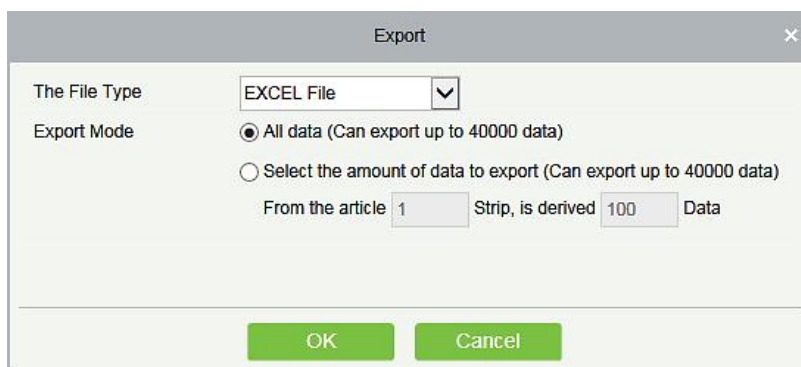

Figure 3- 66 Export

ZKTECO Device										
Device Name	Serial Number	Area Name	Communication Type	Network Connection Mode	IP Address	RS485 Parameter	Enable	Device Model	Register device	Firmware Version
192.168.218.80	20100501999	Area Name	HTTP	Wired	192.168.218.80		Enable	C3-400Pro		AC Ver 4.7.7.3033 Jun 16 2017

Figure 3- 67 Access Level Group by person Export

3.4.5.5 Synchronize Level

Select the level to be synchronized and send the corresponding device area data in the software to the device.

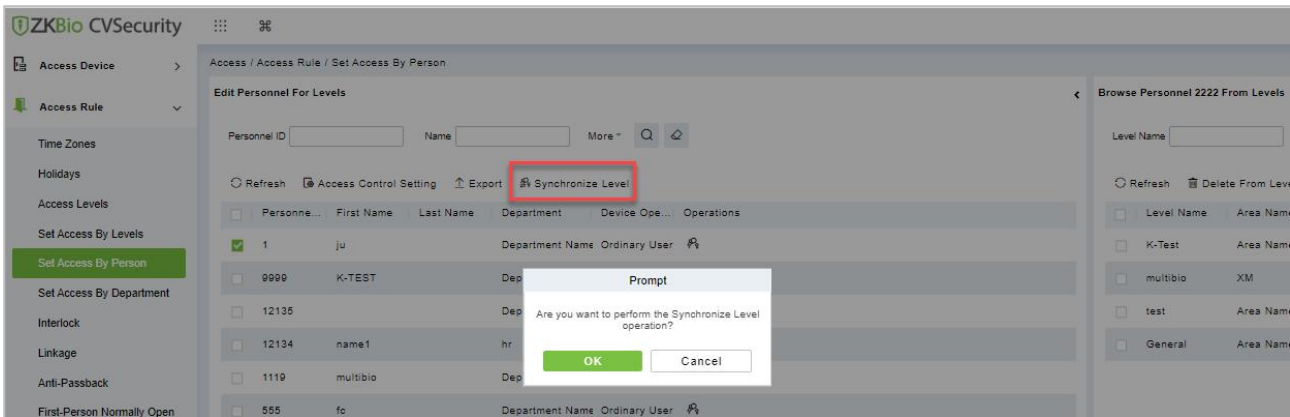

Figure 3- 68 Synchronize Level

3.4.6 Set Access Level Groups by Department

The access level group assigned by department defines the set of access levels for the personnel in the department.

This section describes Operation Step that assigns Access Control group permissions by person in ZKBio CVSecurity.

Operation Step:

Step 1: In the **Access Control** module, choose **“Access Control > Set by department”**.

Step 2: In the Operation column of the Access Control group, click **“Add Access Control Group”**. The page for adding Access Control groups is displayed. Select the Access Control group as required.

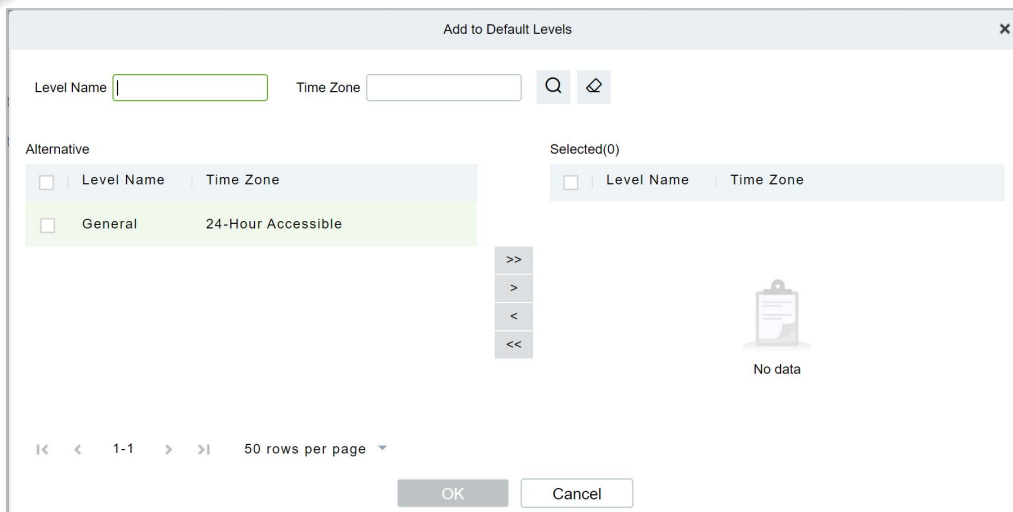

Figure 3- 69 Assigning Rights Groups by Department

Step 3: Click **OK** to complete the assignment of department permissions.

3.4.6.1 Add Default Level

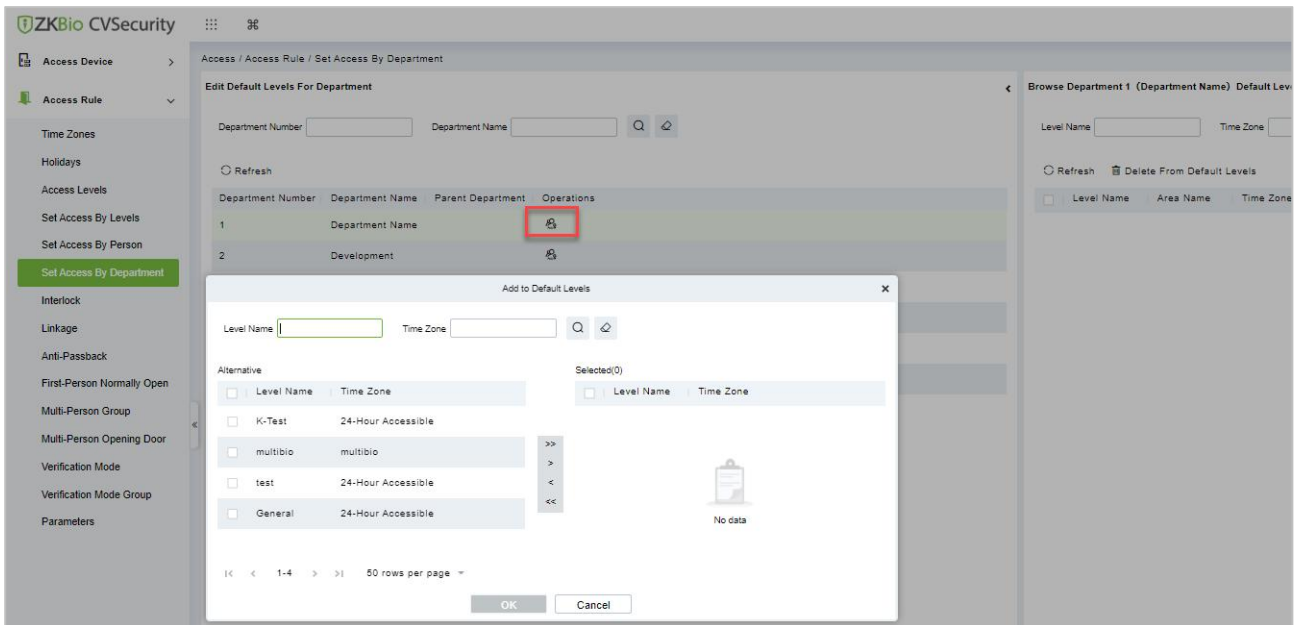

Figure 3- 70 Add Default Level Groups by Department

3.4.6.2 Delete Default Level

Select delete default level name, click **Delete**, and click **OK** to delete the default level name.

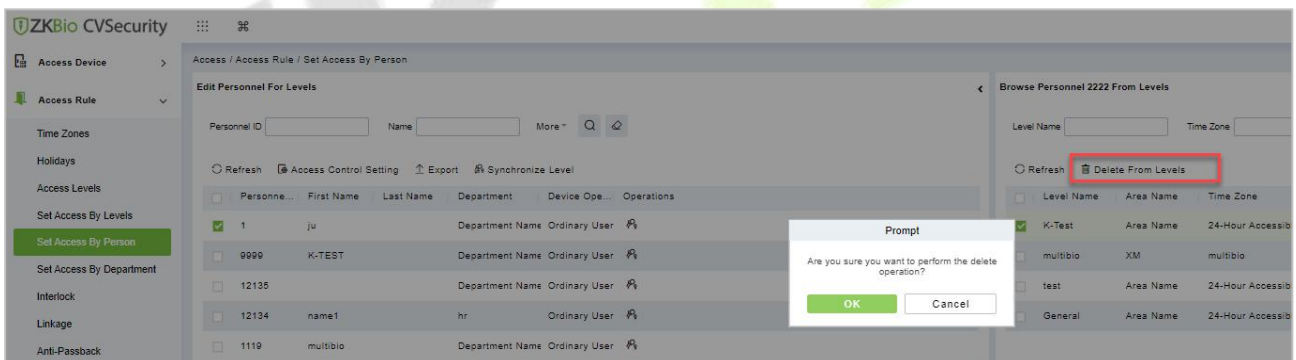

Figure 3- 71 Delete Rights Groups by Department

3.4.7 Interlock

Set interlock control between two or more doors on the access controller device: To verify the opening of a door, ensure that all other doors interlocked with the door are closed; otherwise, the door cannot be opened.

This section describes the Step of adding interlock effect in ZKBio CVSecurity.

The Premise Conditions:

- **The door opening/closing state monitoring is realized by detecting the door magnetic state. Therefore, interlock function requirements:**
 1. The door status sensor at the device end must be correctly installed
 2. In door setting on the software side, the status of the door status sensor must be set to normally open or normally closed (based on the actual installation).

3.4.7.1 Add (New)

Operation Step:

Step 1: In the **Access Control** module, choose "**Access Control > Interlock**" and click **New**.

Step 2: Select the specified device.

Instructions:

When you add a device for which interlock has been configured, the device cannot be found in the drop-down list. After the configured interlock information is deleted, the device is returned to the drop-down list.

Interlock Settings vary with the number of doors controlled by the device:

Single-door controller: no interlock setting

Dual door controller: 1-2 two door interlock Settings

Four-door controller: 1-2 two-door interlock, 3-4 two-door interlock, 1-2-3 three-door interlock, 1-2-3-4 four-door interlock, 1-2 and 3-4 door interlock

Step 3: Select the interlock rule, and click **OK** to complete the settings, as shown in Figure 3-52. The new interlock Settings are displayed in the list.

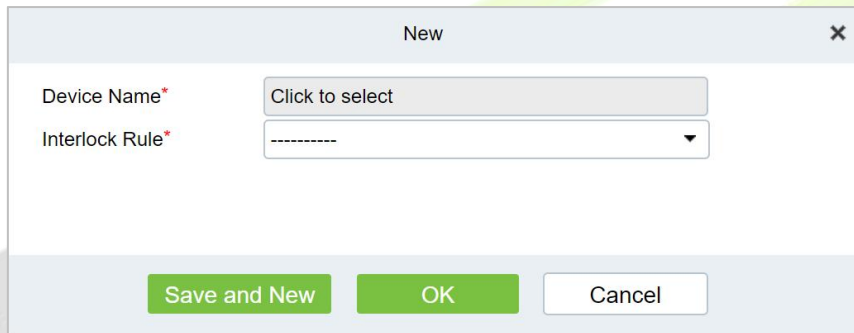

Figure 3- 72 Adding Interlock Configuration

Parameter	How to set up
Device Name	You can customize the name of the Device
Interlock Rule	Select the configured interlock rule.

Table 3- 12 Description of interlock

3.4.7.2 Delete

Select interlock, click **Delete**, and click **OK** to delete the interlock.

3.4.8 Linkage

The use method and scenario of linkage are flexible. After a specific event is triggered by an input point in the **Access Control** system, a linkage action will be generated at the specified output point to control events such as verification opening, alarm and abnormality in the system.

This section describes how to add Step to the linkage effect in ZKBio CVSecurity.

● Add (New)

The Premise Conditions:

Before adding a linkage configuration, perform the following operations:

Step 1: Add Settings for binding cameras to access control devices, input points, output points, and

read heads.

Step 2: Optional: In the **System Management** module, choose "**System Management > Mail Management**" to set the sender server. The Step of setting the sender server is as follows:

In the System Management module, choose 'system Management > Mail Management'.

Click "**Sender Server Settings**" to pop up the sender server Settings interface.

On the Sender server Settings screen, set parameters as required, as shown in Figure 3-73. For parameter Settings, see Table 3-13.

After setting, click "**Test connection**" to receive the email, indicating that the test has passed.

Step 3: Click **OK** to finish setting email parameters.

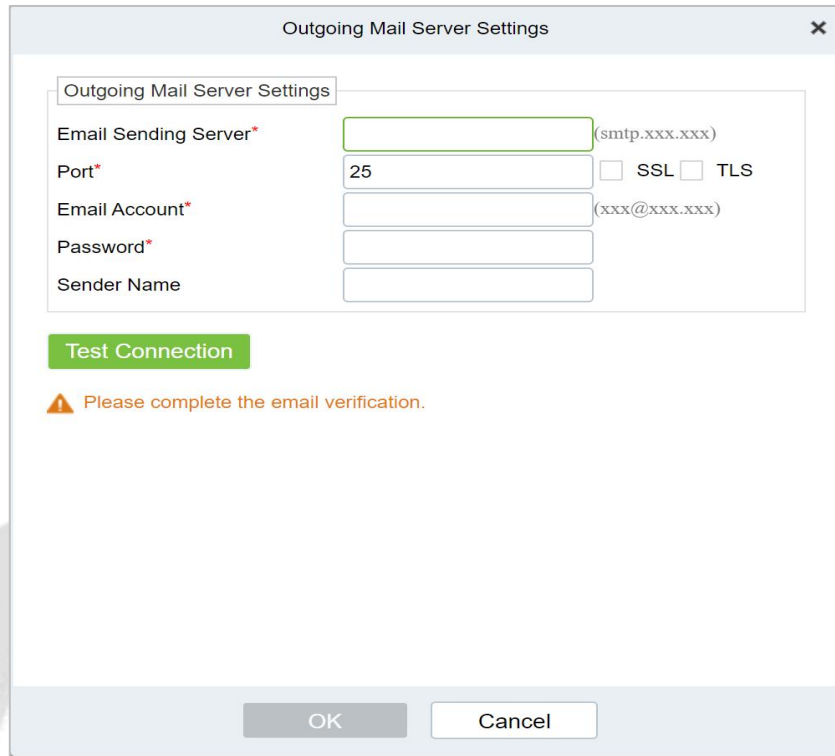

Figure 3- 73 Mailbox Parameters

Parameter	How to set up
Email server address/port	You can customize the email server address and port. The email products that provide the SMTP server can be used, such as NetEase 163 email, Tencent QQ email, and Foxmail email. The specific address and port configurations must be obtained from the corresponding provider.
Email username and password	Enter the user’s name and password for the mailbox.
Name of sender	Sets the name of the sender on the received message.

Table 3- 13 Mailbox Management Parameters

Operation Step:

Step 1: In the **Access Control** module, choose "**Access Control > Linkage**".

Step 2: On the linkage setting screen, click **Add**, as shown in Figure 3-69. Table 3-14 and Table 3-15 refer to the linkage parameters.

Figure 3- 74 New Linkage Configuration

Parameter	How to set up
Linkage Name	You can customize the linkage name for easy query.
Equipment	Custom Select an added access control device.
Linkage Departure Condition	Select the condition triggered by the linkage Operation, that is, the event type generated by the selected device.
Input Point	Select the input point to set device input.
Dots	Select the output point to set device output.
Linkage Action Setting	You can set the linkage action, including Operation, video linkage, and email. Table 3-3 describes the configurations of the three modes.

Table 3- 14 New Linkage Parameters

Parameter	How to set up
The Output Point of Operation	Set the output action type: close, open, normally open. Sets the delay time if the output action is on.
Video Linkage	Pop-up video and display duration: Select pop-up video on the real-time monitoring screen and set the pop-up duration. Video recording and Video Duration: Select Video recording to set the video duration. Capture: Set linkage action whether to take a photo: If a photo is taken, you also need to set whether to pop up on the real-time monitoring interface and the display duration.
Mail	Set the email address that receives the linkage content when a linkage event occurs.

Table 3- 15 Setting Linkage Actions

Step 3: Click **OK** to complete the linkage configuration.

3.4.8.1 Delete

Select linkage, click **Delete**, and click **OK** to delete the linkage.

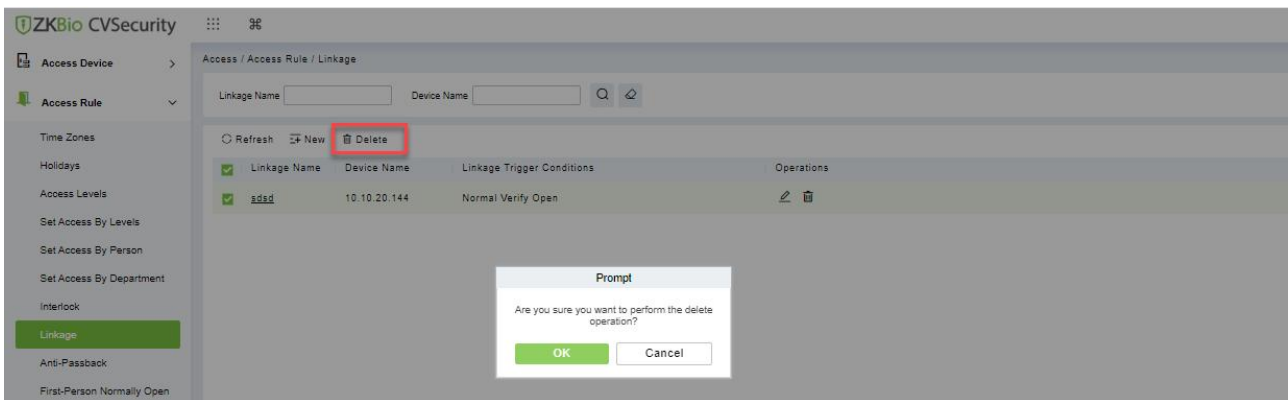

Figure 3- 75 Adding Interlock Configuration

3.4.9 Anti-Passback

Some occasions require the personnel that brush card to verify, brush card to come in from a door must brush card to go out from another door, brush card record must enter a strict correspondence. This function can be used when users enable it in the settings. It is generally used in special units, scientific research, bank vaults and other occasions.

This section describes the Step of adding the Anti-Passback effect in ZKBio CVSecurity.

3.4.9.1 Add (New)

Operation Step:

Step 1: In the **Access Control** module, choose "**Access Control > Anti-Passback**" and click **New**.

Step 2: Select the specified device.

Instructions:

When you add an Anti-Passback device, the configured Anti-Passback device is not displayed in the device list. After the antisubmarine information is deleted, the device returns to the device list.

The Anti-Passback setting varies with the number of gates controlled by the equipment:

Anti-Passback setting of single door controller: Anti-Passback between readers

Two controllers: door 1 Anti-Passback between readers, door 2 Anti-Passback between readers, door 1 and door 2 Anti-Passback

Four door controllers: door 1 and door 2 Anti-Passback, door 3 and door 4 Anti-Passback, door 1/ door 2 and door 3/ door 4 Anti-Passback, door 1 and door 2/ door 3/ door 4 Anti-Passback, door 1 and door 2/ door 3/ door 4 Anti-Passback reader

Step 3: Select the Anti-Passback rule and click **OK** to complete the settings. The new Anti-Passback Settings are displayed in the list.

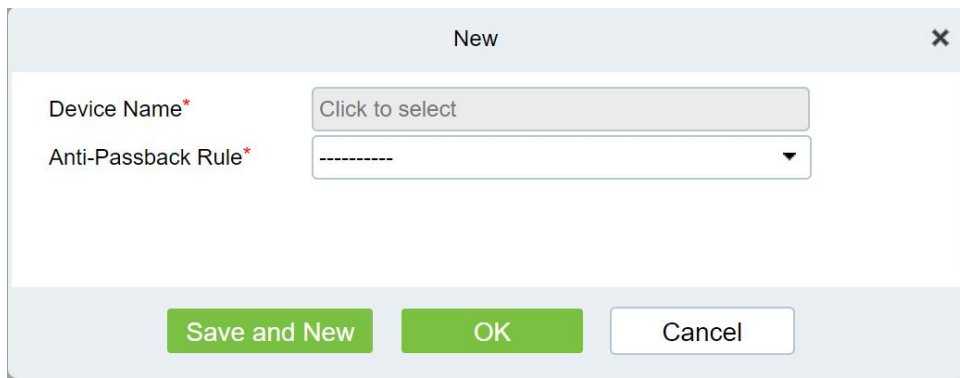

Figure 3- 76 Adding the Anti-Passback Configuration

3.4.9.2 Delete

Select device, click **Delete**, and click **OK** to delete the device.

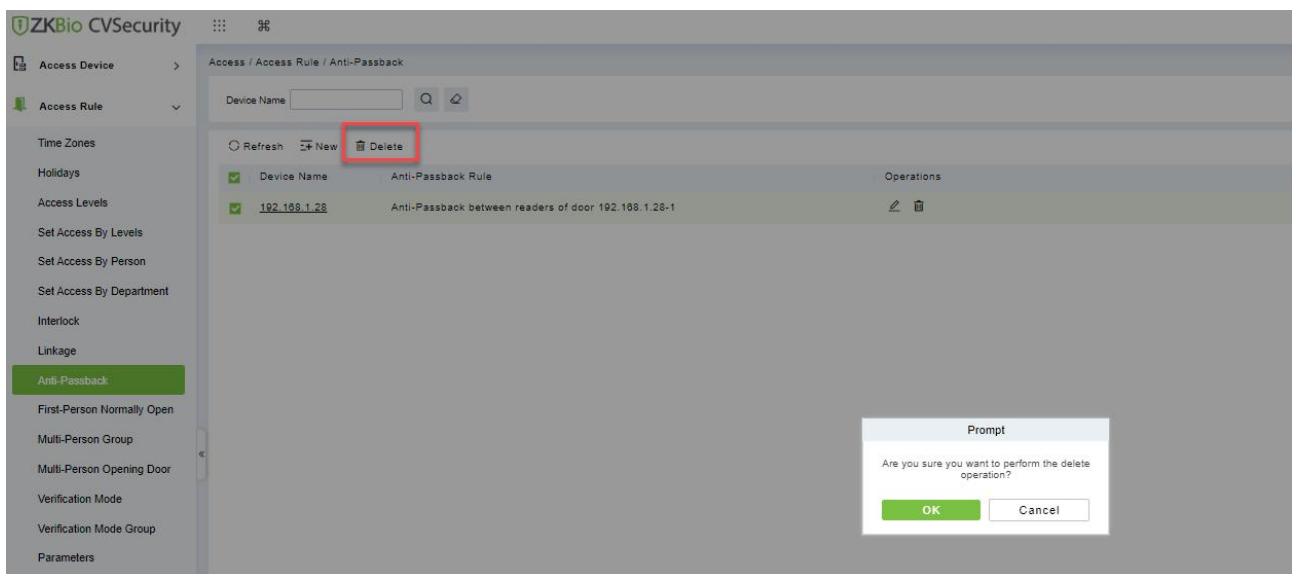

Figure 3- 77 Anti-Passback Delete

3.4.10 The First-Person Normally Open

In the specified period, after the verification of the first person with normally open permission, the door normally open, the end of the valid period of the door automatically closed.

This section describes how to add Step in ZKBio CVSecurity.

The Premise Conditions:

The time range has been set for the Access Control module.

3.4.10.1 Add (New)

Operation Step:

Step 1: In the **Access Control** module, choose "**Access Control > First person normally Open**" and click **New**.

Step 2: Select the specified device, add Settings for the specified door, and select the normally open time period, and click **OK**, as shown in Figure 3-58.

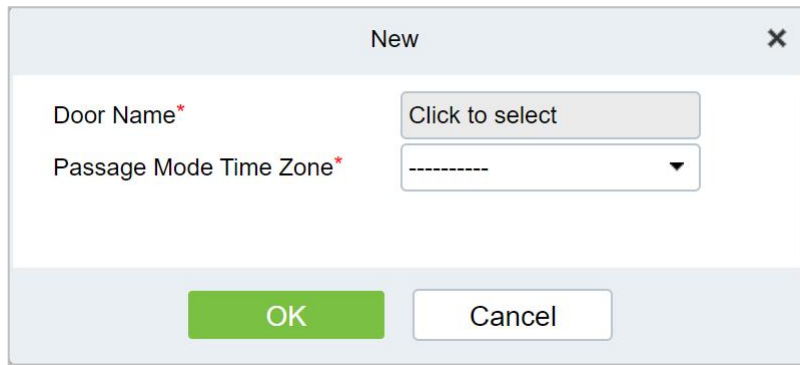

Figure 3- 78 Configuring the First Person to Open the Door

Step 3: Click "Add People" on the interface of "Opening of the first person". After adding people, click **OK** to complete the setting of "opening of the first person".

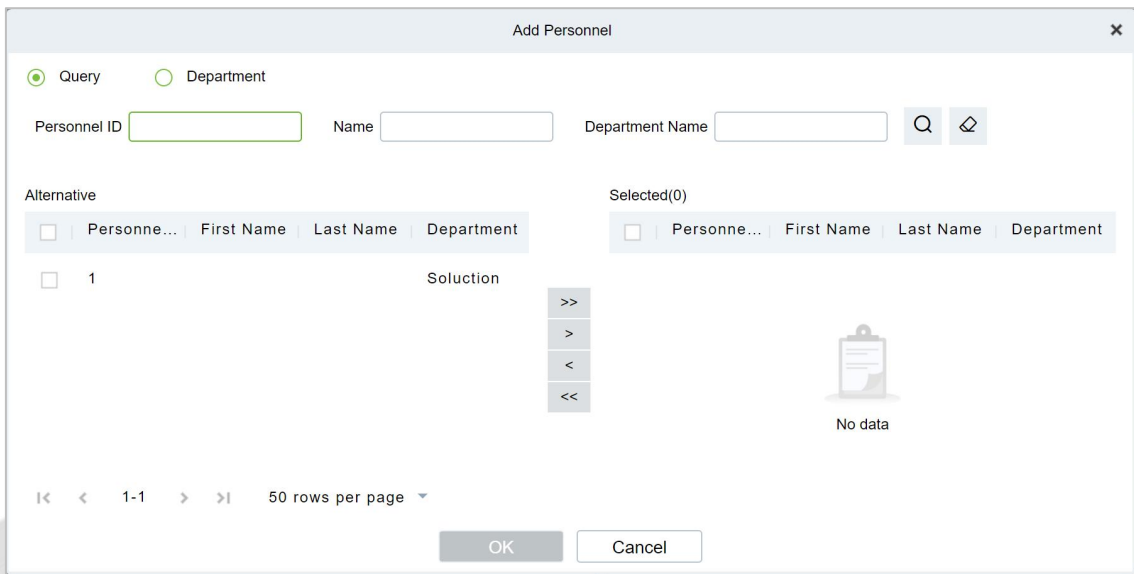

Figure 3- 79 Adding A First Person Normally Open Person Configuration

3.4.10.2 Delete

Select personnel ID, click **Delete**, and click **OK** to delete the personnel ID.

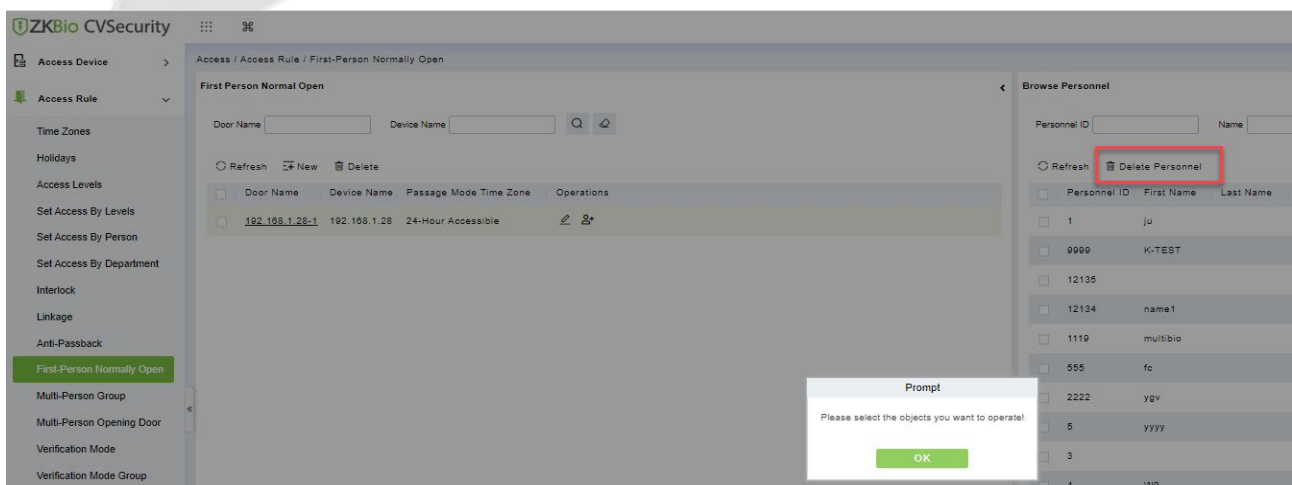

Figure 3- 80 Delete Person Normally Open Person Configuration

3.4.11 Multi-Person Group

The door will open only after the consecutive verification of multiple people. Any person verifying outside of this combination (even if the person belongs to other valid combination) will interrupt the procedure and you need to wait 10 seconds to restart verification. It will not open by verification by only one of the combinations.

3.4.11.1 Add (New)

Step 1: Click **Access Rule > Multi-Person Group > New** to access the following edit interface:

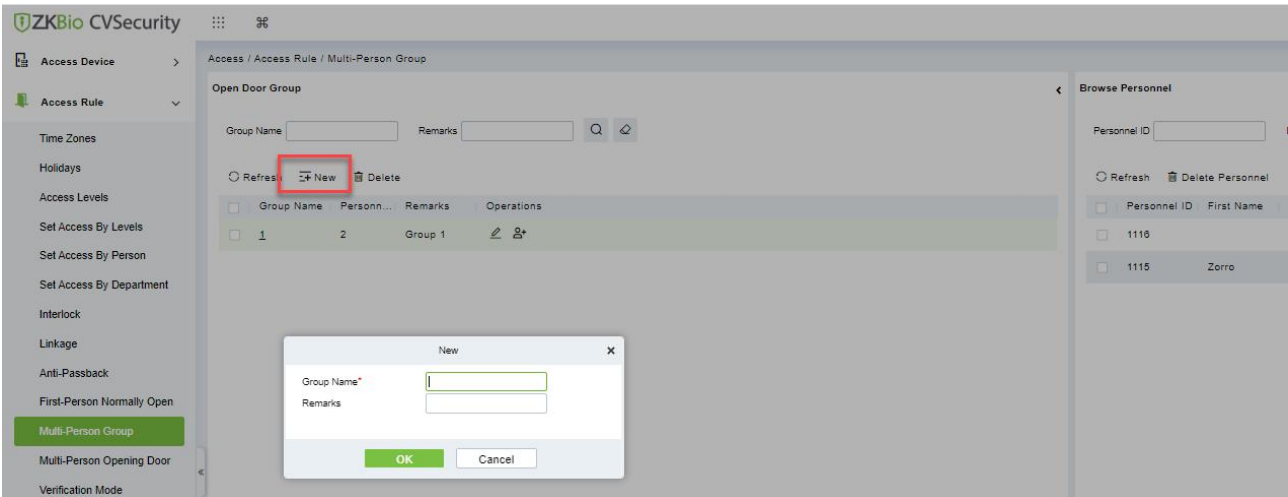

Figure 3- 81 Adding A Multi-Person Group

Group Name: Any combination of up to 30 characters that cannot be identical to an existing group name.

After editing, click **OK** to save and return. The added Multi-Person Personnel Group will appear in the list.

Step 2: Click **Add personnel** under Related Operations to add personnel to the group.

Step 3: After selecting and adding personnel, click **OK** to save and return.

Note: A person can only be grouped into one group.

3.4.11.2 Edit

Click **Access Rule > Multi-Person Group > Edit** after selecting the required section in the interface.

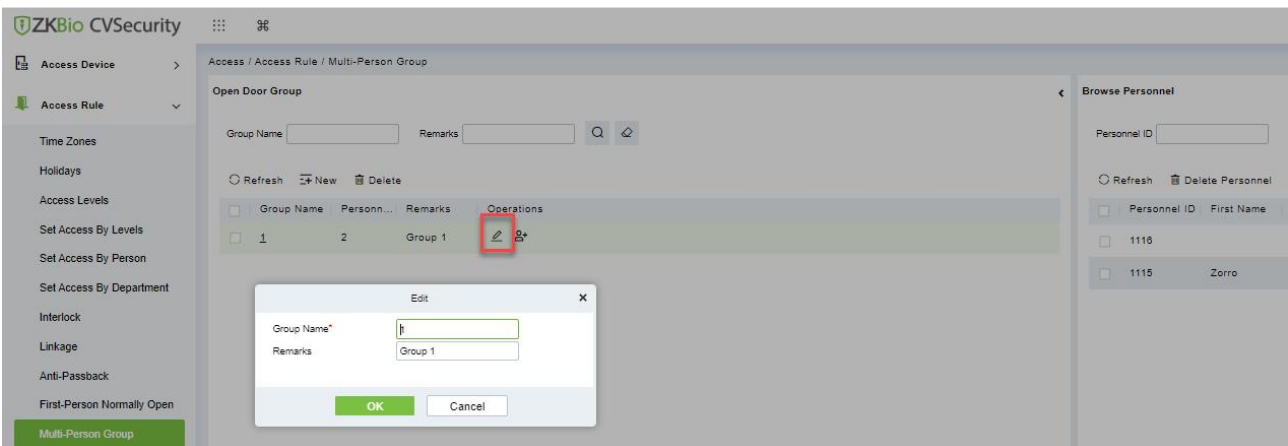

Figure 3- 82 Edit Multi-Person Group

3.4.11.3 Add Personnel

Click **Access Rule > Multi-Person Group > Add Personnel** after selecting the required section in the interface.

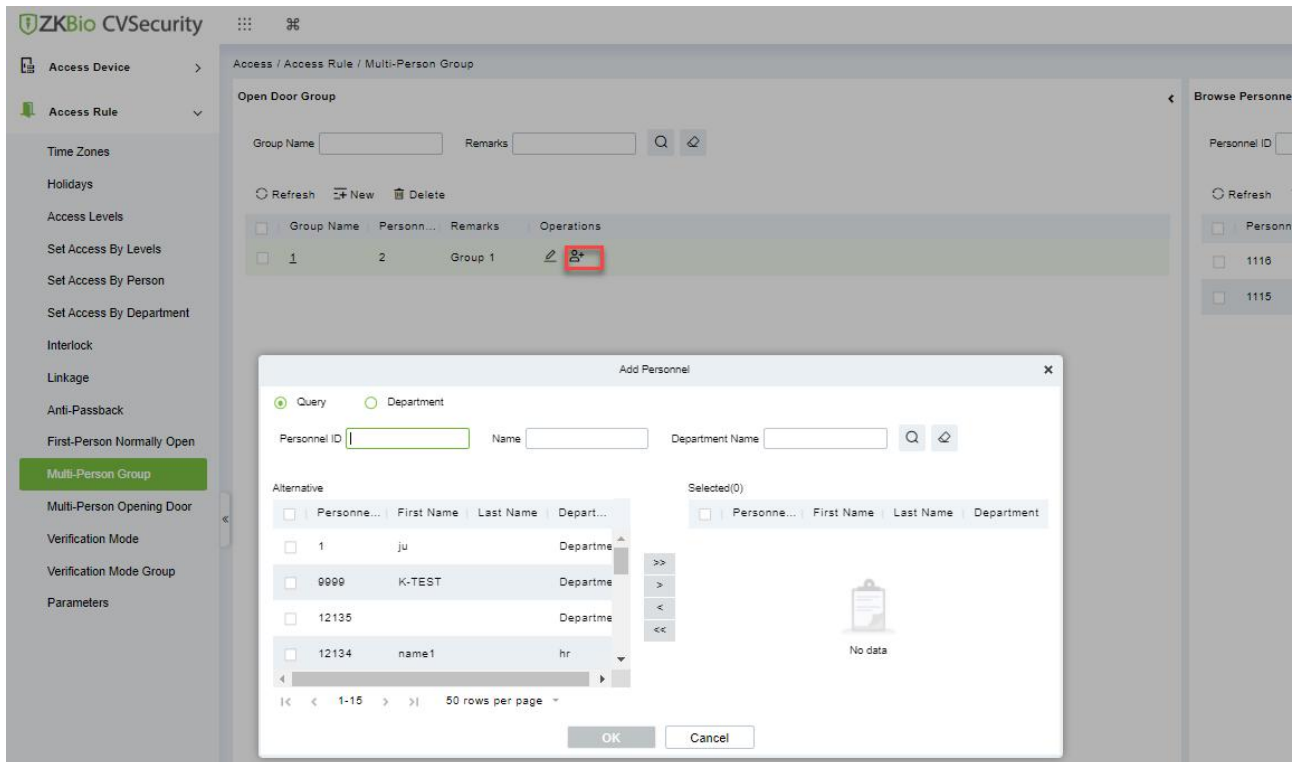

Figure 3- 83 Adding A personnel for Multi-Person Group

3.4.11.4 Delete

Click **Access Rule > Multi-person group > Delete** after selecting the required section in the interface.

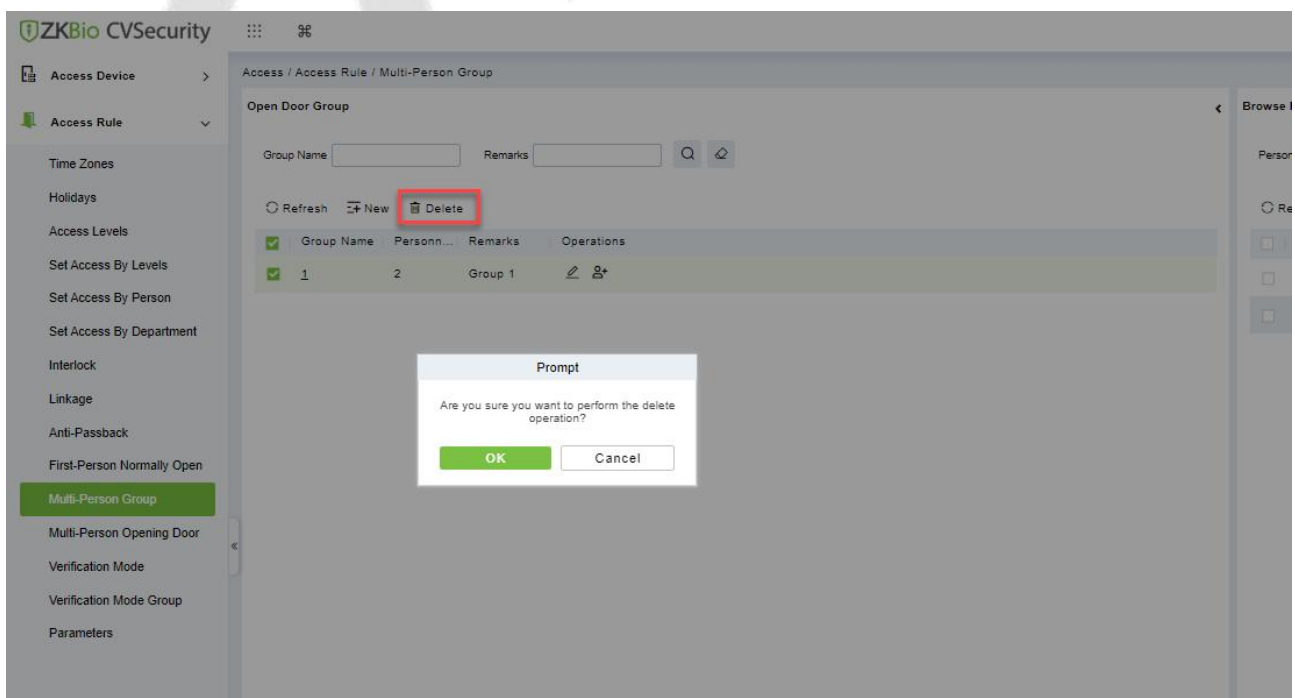

Figure 3- 84 Delete A Multi-Person Group

3.4.12 Multi-People Open The Door

In a specific scenario, it is necessary for more than one person to be present at the same time to verify their identity before they can open the door through permission verification.

Instructions:

1. In an application scenario where, multiple users are required to verify their identities before opening the door, the authentication process is limited to N (no more than 5) by grouping people into groups.
2. In practice, if all the personnel to be verified are of the same type or level, it can be verified by multiple people in a single group. If there are different categories or levels of personnel, you can set a certain number of personnel in each group to achieve verification.
3. Before the multi-party door verification rule is reached, if the verification fails during the process, wait 10 seconds for the verification again.

3.4.12.1 Add (New)

Step 1: In the **Access Control** module, choose "**Access Rule > Multiple Door Opening Personnel Group**" and click **New**. After filling in the corresponding parameters, click **OK** to save the settings.

Step 2: Click "**Add Personnel**" on the right of the list of created multi-person door opening personnel, select the personnel to be added to the group in the pop-up function, and click **OK** to save the settings.

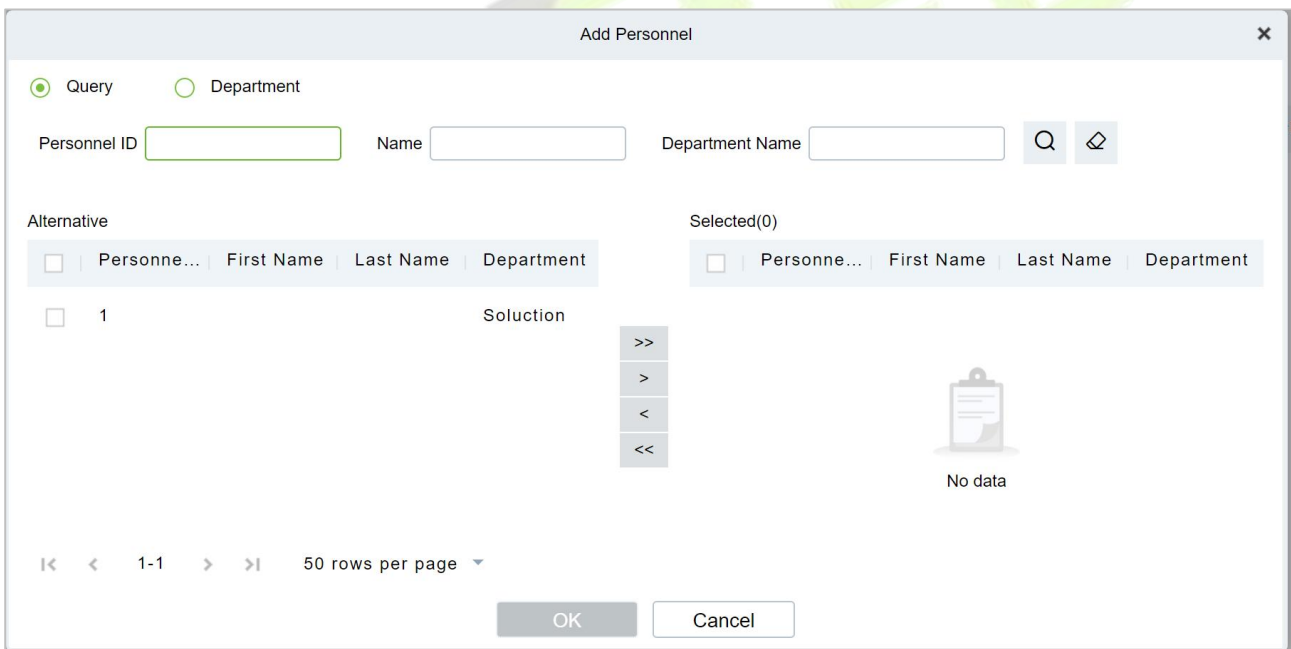

Figure 3- 85 Adding Multiple Door Openers

Step 3: In the multi-person door opening interface, click **Add**, set permissions for multi-person door opening personnel group.

Step 4: On the page for adding multiple door users, select the specified door, group information for multiple door users, and the number of verification personnel for each group, and click **OK** to save the settings.

The 'New' dialog box contains the following fields and controls:

- Door Name***: A button labeled 'Click to select'.
- Combination Name***: An empty text input field.
- Number of opening personnel in each group**: A table with 5 rows (Group1 to Group5). Each row has a dropdown menu for selection, a numeric input field (all set to 0), and a count in parentheses (all set to (0)).
- Buttons**: 'OK' and 'Cancel' buttons at the bottom.

Figure 3- 86 Adding Multiple Door Openers

Step 5: In the **Access Control** module, choose **“Access Rule > Authentication Mode Rule”** and click **Add** to set the access control authentication rule for the corresponding period.

The 'New' dialog box for authentication mode rule configuration includes:

- Rule Name***: An empty text input field.
- Time Zones***: A dropdown menu.
- Table**: A grid with columns for Date, Time, and three intervals (Interval 1, Interval 2, Interval 3). Each interval has sub-columns for Start Time, End Time, Door Verification, and Personnel Verification. Rows include days of the week (Monday to Sunday) and holiday types (Holiday Type 1, 2, 3).
- Copy Monday's Setting to Others Weekdays:** A checkbox.
- Warning:** A red triangle icon with the text: "RS485 reader can only follow the door verification mode, does not support the personnel verification mode."
- Buttons:** 'Save and New', 'OK', and 'Cancel' buttons at the bottom.

Figure 3- 87 Delete A Multi-Person Group

Step 6: Click **Add Door** on the right of the created authentication mode rule, select a door, and set the authentication mode rule for the door.

The 'Add Door' dialog box contains the following elements:

- Door Name**: An empty text input field.
- Serial Number**: An empty text input field with search and refresh icons.
- Alternative**: A table with columns: Door Name, Owned Device, Serial Number. It contains one entry: ProfaceX-1, ProfaceX, CN3M2124600.
- Selected(0)**: An empty table with the same columns as the Alternative table.
- Navigation**: Arrow buttons (>>, >, <, <<) between the tables.
- No data**: A message with a clipboard icon.
- Footer**: A pagination bar showing '1-1' and '50 rows per page', and 'OK' and 'Cancel' buttons.

Figure 3- 88 Verification Rule Configuration for Adding Multiple Door Openers

Step 7: click **OK** to save the settings.

3.4.12.2 Delete

Click **Access Rule > Multi-person opening door > Delete** after selecting the required section in the interface.

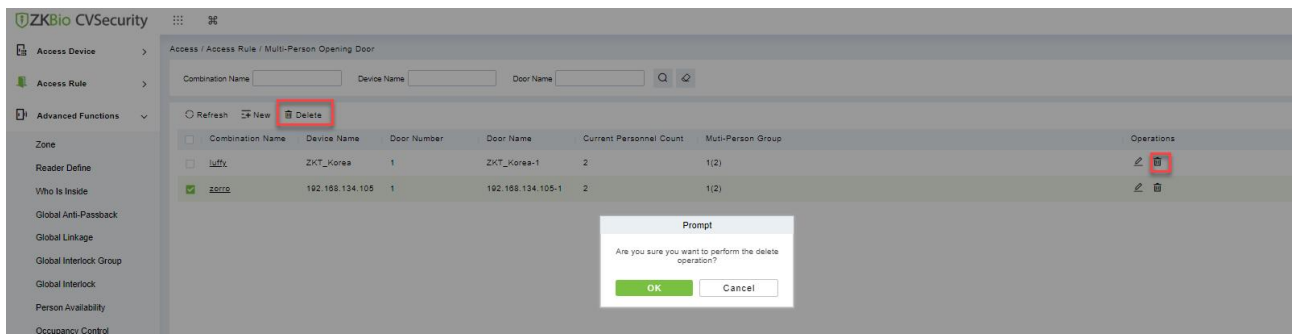

Figure 3- 89 Delete A Multi-Person Group

3.4.13 Verification Mode

Verification Mode:

You can set verification modes for doors and personnel separately in a specified time segment.

3.4.13.1 New

Step 1: Click **Access Rule > Verification Mode > New** to go to the page for adding a verification mode rule.

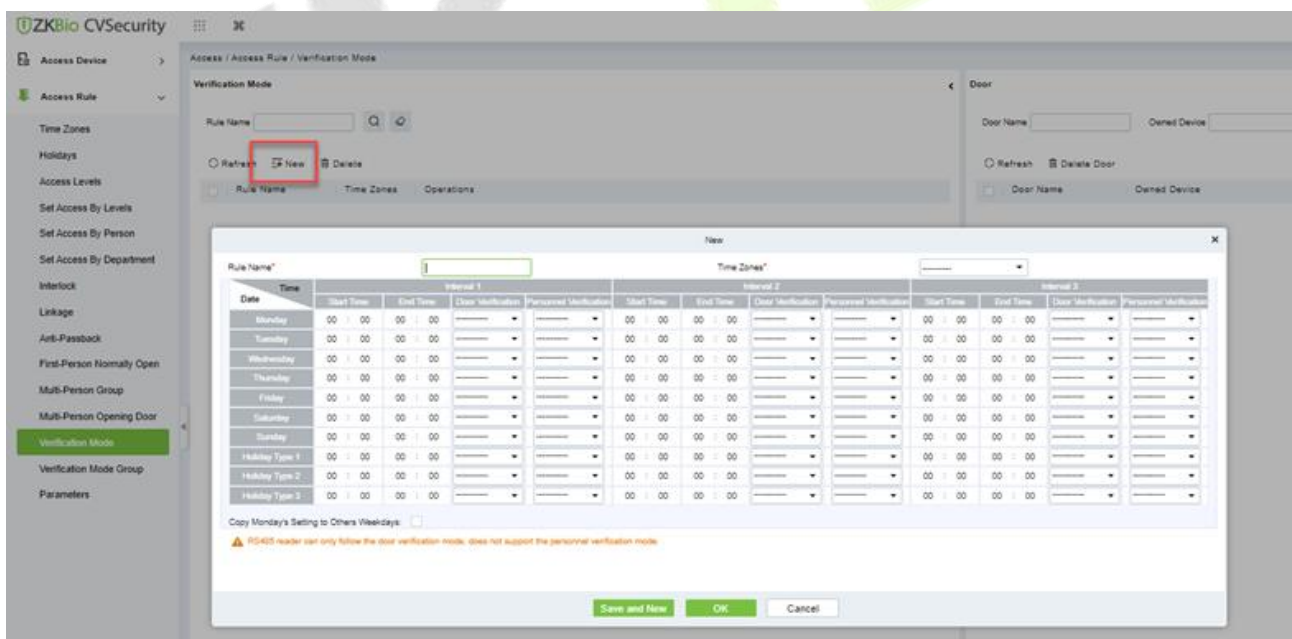

Figure 3- 90 Add Verification mode

Step 2: Set the following parameters: Select a rule name (not repeatable), the time segment, and verification mode for a door or person in each time segment.

Step 3: Click **OK** to finish the setting.

On the list page, you can add or delete doors in the verification mode rule.

3.4.13.2 Verification Mode Group

You can set verification modes for doors and personnel separately in a specified time segment.

Steps:

Step 1: Click **Access Rule > Verification Mode > New** to go to the page for adding a verification mode rule.

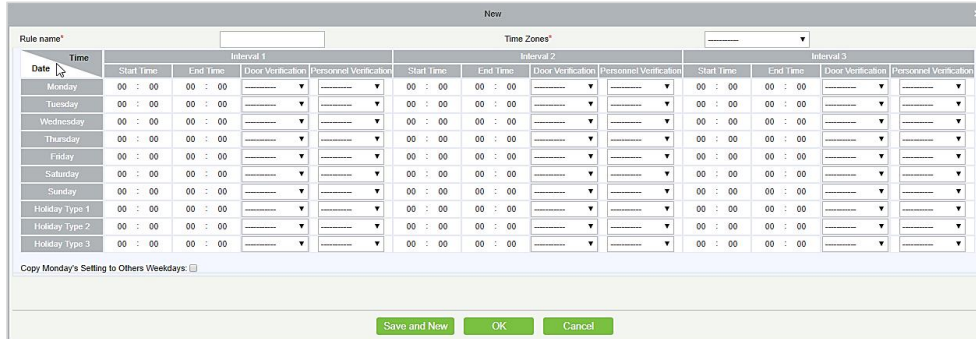

Figure 3- 91 Add Verification mode Group

Step 2: Set the following parameters: Select a rule name (not repeatable), the time segment, and verification mode for a door or person in each time segment.

Step 3: Click OK to finish the setting.

On the list page, you can add or delete doors in the verification mode rule.

Note: If a rule includes the verification mode for personnel, you cannot select doors with the RS485 readers when adding doors. You can modify only the configuration on the reader setting page before adding doors.

Verification Mode Group:

Set appropriate personnel for configured verification mode rule.

3.4.14 Parameters

Click **Access Rule > Parameters** to enter the parameter setting interface:

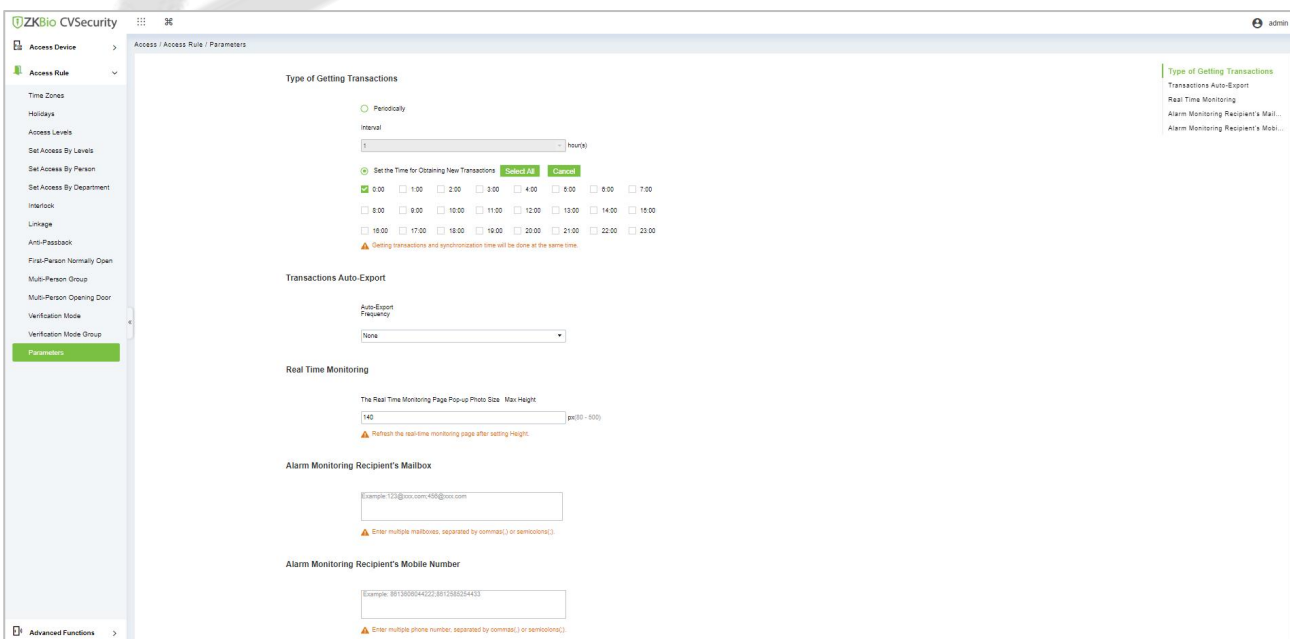

Figure 3- 92 Add Parameters

Type of Getting Transactions:

- **Periodically**

Start from the setting and efficient time, the system attempts to download new transactions every time interval.

- **Set the Time for Obtaining New Transactions**

The selected Time is up, the system will attempt to download new transactions automatically.

- **Transaction Auto-Export**

The user can choose the export frequency and the data to be exported each time. If the export frequency is selected as **“By day”**, you must set the time to export the data. You must also select the mode of export. It can be daily transactions or all the system data (30000 data units can be sent at a time. We can customize the data that we need to export from custom report 1 and custom report 2.

If the export frequency is selected as **“By Month”**, you must select the day to export the data. It can be the first day of the month or you can specify any particular date. Then select the export frequency as Daily Data or all System data. Finally, add the recipient’s mail address to send the transaction data.



Figure 3- 93 Transaction Auto Export

- **The Real Time Monitoring Page Pop-up Staff Photo Size**

When an access control event occurs, the personnel photo will pop up. The size of pop photos shall be between 80 to 500 pixels.



Figure 3- 94 Real Time Monitoring

- **Alarm Monitoring Recipient Mailbox**

The system will send email to alarm monitoring recipient’s mailbox if there is any event.



Figure 3- 95 Alarm Monitoring Recipient Mailbox

- **Alarm Monitoring Recipient Mobile Number**

The system will send alarm monitoring recipients to mobile, if there is any event.

Alarm Monitoring Recipient's Mobile Number

Example: 8813808044222;8612585254433

⚠ Enter multiple phone number, separated by commas(,) or semicolons(;).

Figure 3- 96 Alarm Monitoring Recipient Mobile Number

3.5 Advanced Function

Advanced access control is optional. You must obtain permission to activate the advanced access control.

In addition to the global linkage function, enable the background authentication function first.

The access control area must be defined when advanced functions such as global Anti-Passback are used.

3.5.1 Entrance Guard Area(Zone)

Divide areas and define access control areas. The access control area is reserved for advanced access control but not for system management.

This section describes Step in ZKBio CVSecurity to add an access control area.

3.5.1.1 Add (New)

Operation Step:

Step 1: In the **Access Control** module, choose "**Advanced function > zone**" and click **New**.

Step 2: On the page that is displayed, set related parameters, and click **OK**.

New [X]

Zone Code*

Name*

Remarks

OK

Figure 3- 97 Page for Adding Access Control Areas

3.5.1.2 Delete

Click **Advanced function > Zone > Delete** after selecting the required section in the interface.

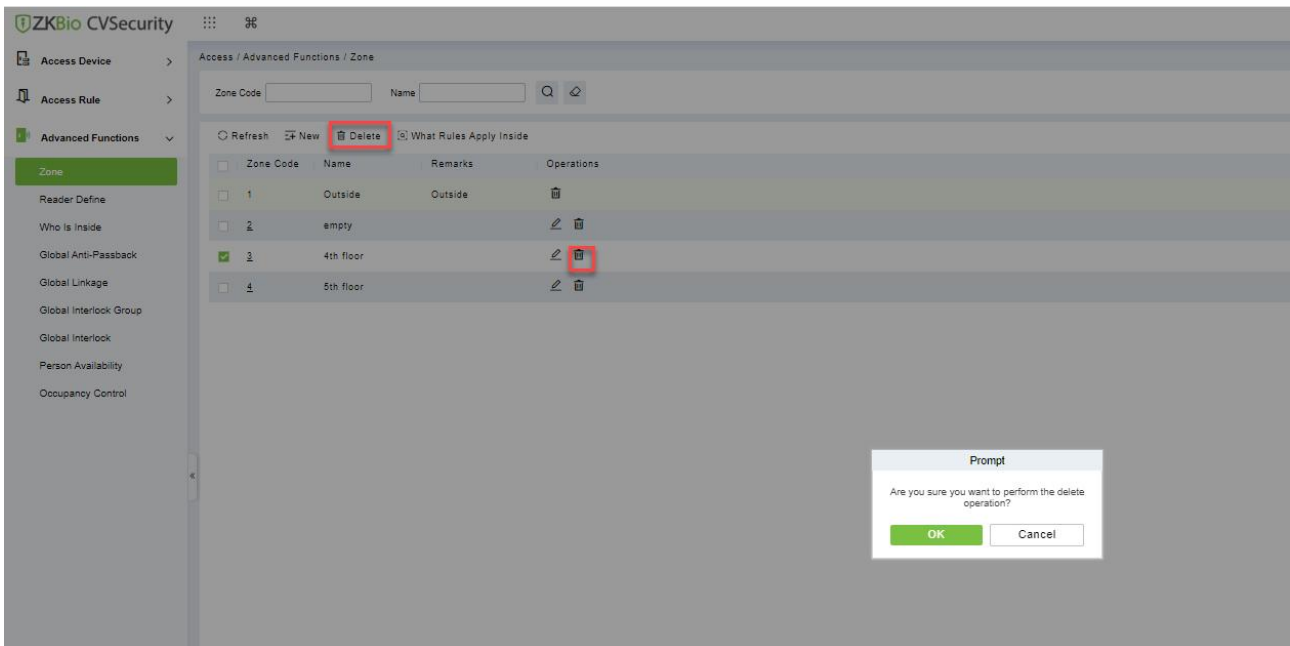

Figure 3- 98 Delete Access Control Areas

3.5.1.3 What rules Apply Inside

Click **What rules inside** after selecting the required section in the interface we can check the rules are applied for the particular zone.

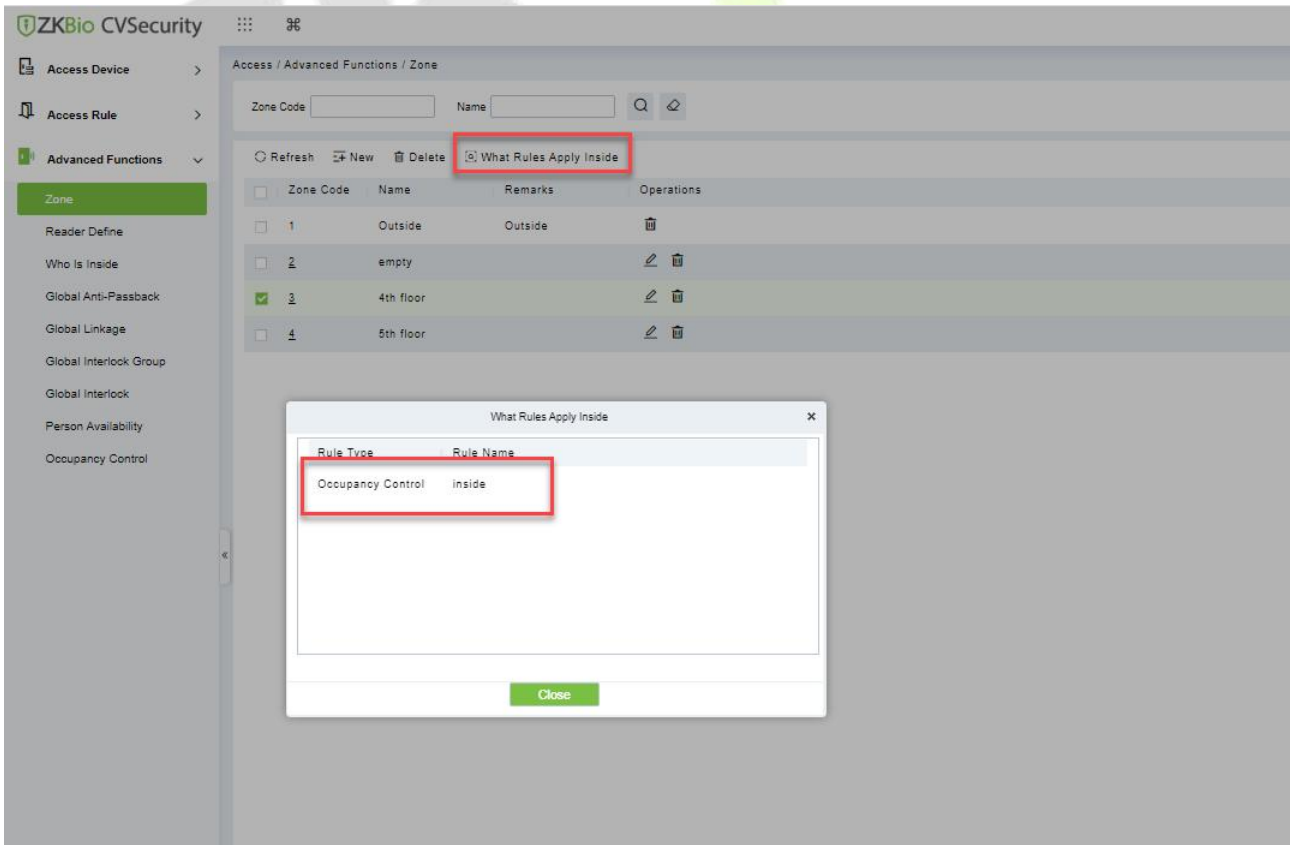

Figure 3- 99 What Rules Apply Inside

3.5.2 Reader Definition

This function is configured based on the access control area. To use the global Anti-Passback function, you must define the read head.

This section describes the Step of adding a Reader definition in ZKBio CVSecurity.

3.5.2.1 Add (New)

Operation Step:

Step 1: In the **Access Control** module, choose "**Advanced function > Reader Define**" and click **New**

Step 2: On the page that is displayed, set related parameters and click **OK**.

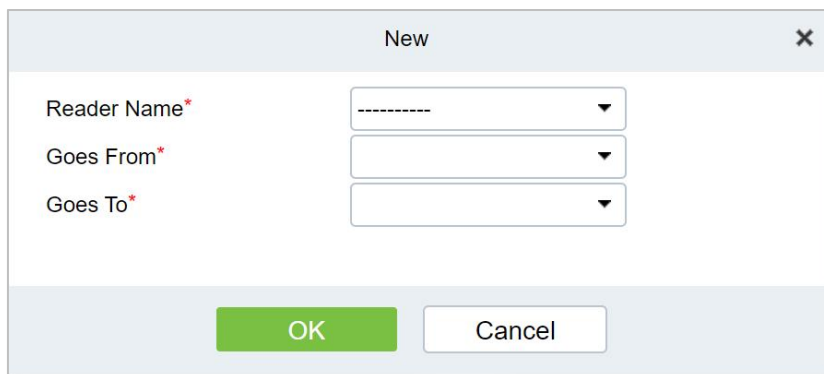

Figure 3- 100 Page for Adding a Reader

3.5.2.2 Batch New

Step 1: Click **Advanced Functions > Reader Define > Batch New** to enter the batch add interface:

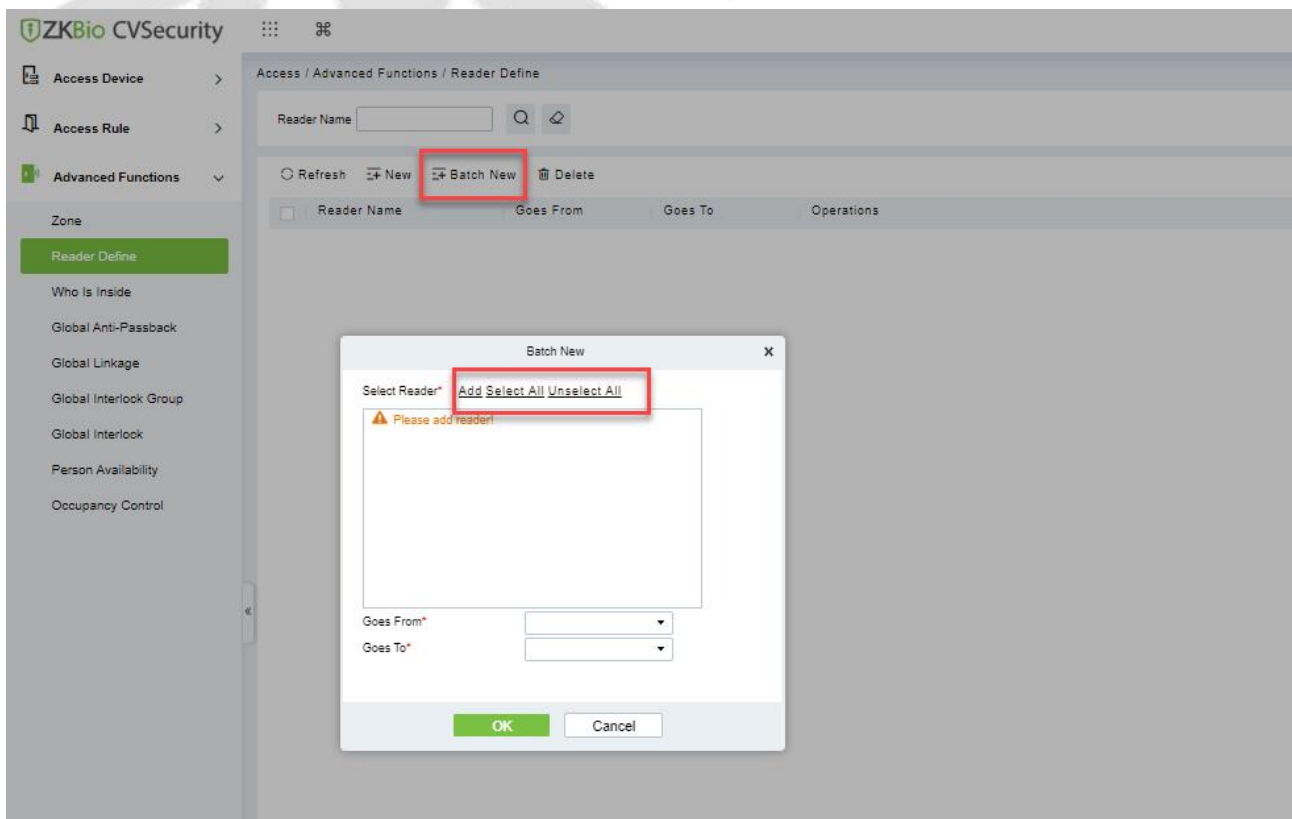

Figure 3- 101 Batch New

Step 2: Click **Add**, select Reader(s) and move towards right and click **OK**.

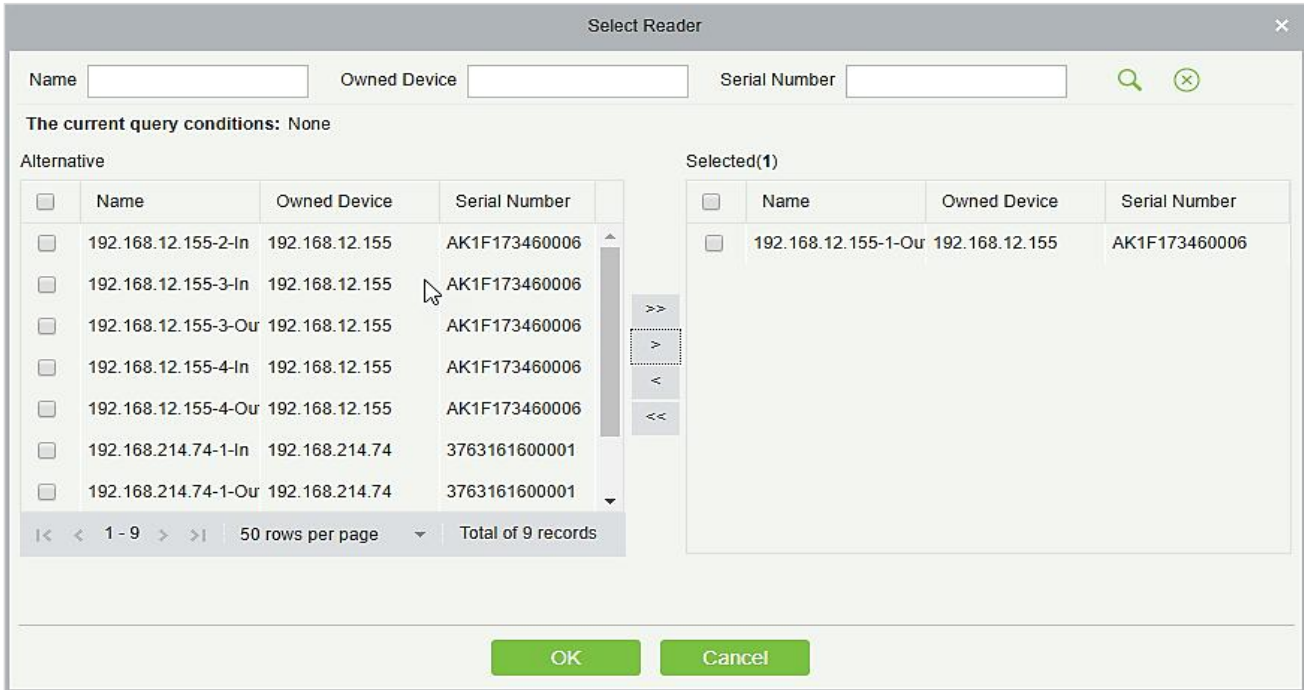

Figure 3- 102 Add Reader Define

Step 3: Set Goes from and Goes to as required and press **OK**.

3.5.2.3 Delete

In the **Access > Advanced Functions > Reader Define**, click **Delete** button under Operations. Click **OK** to delete.

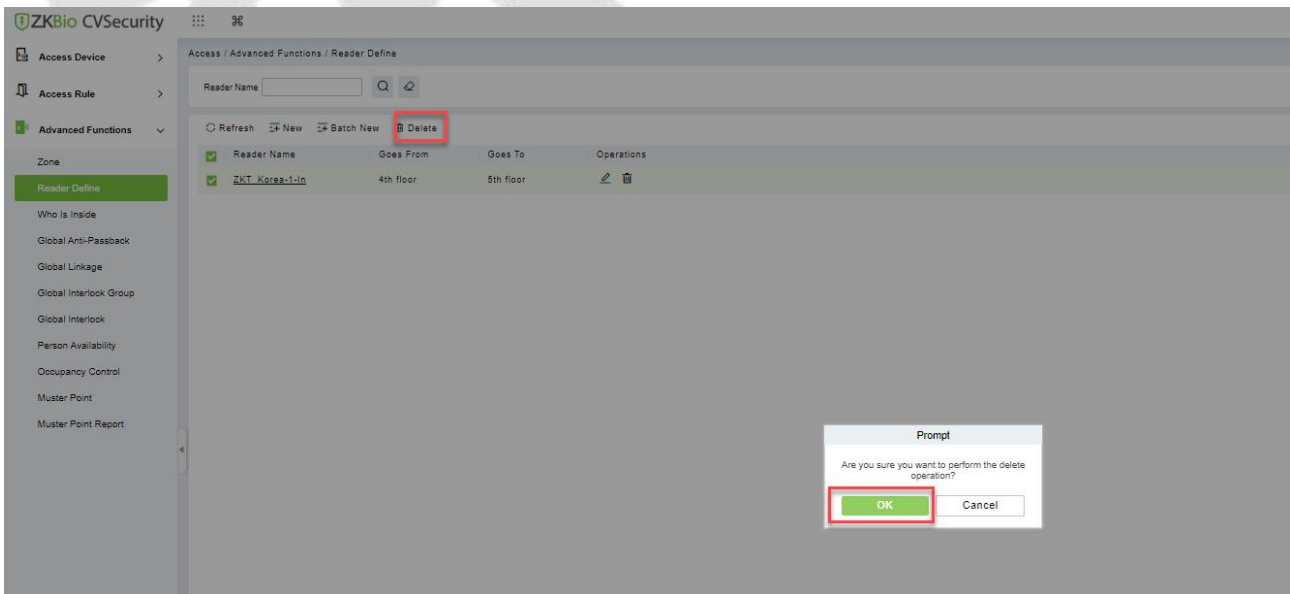

Figure 3- 103 Delete Reader Define

3.5.3 Who is inside

After entering the access control area, users can use this function to view the personnel in the access control area. You can choose the access control area tree to view the personnel in the corresponding access control area.

This section describes how to view the Steps of people in a region in ZKBio CVSecurity.

Operation Step:

Step 1: In the **Access Control** module, choose "**Advanced Function > View Personnel in the Area**"

Step 2: On the page for viewing personnel in a region, you can select the area on the left to view and delete personnel in the area, as shown in Figure 3-84.

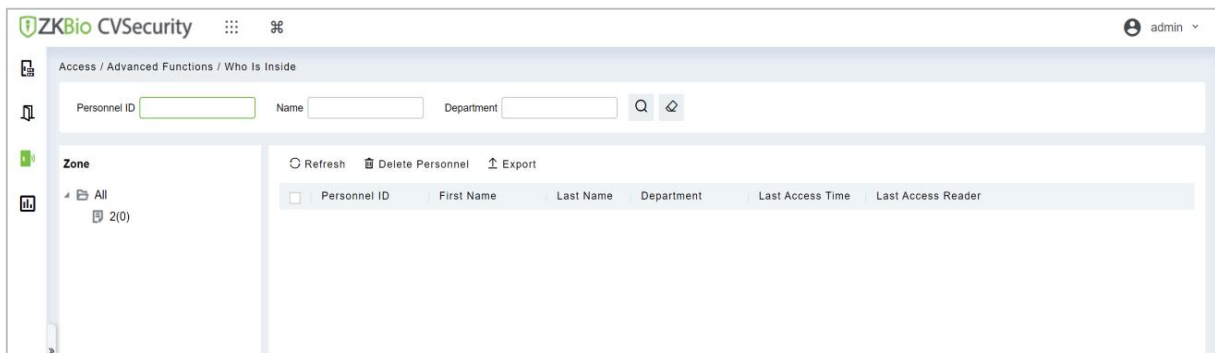

Figure 3- 104 View Area Personnel Page

3.5.3.1 Delete personnel

Select personnel ID, click **Delete**, and click **OK** to delete the level name.

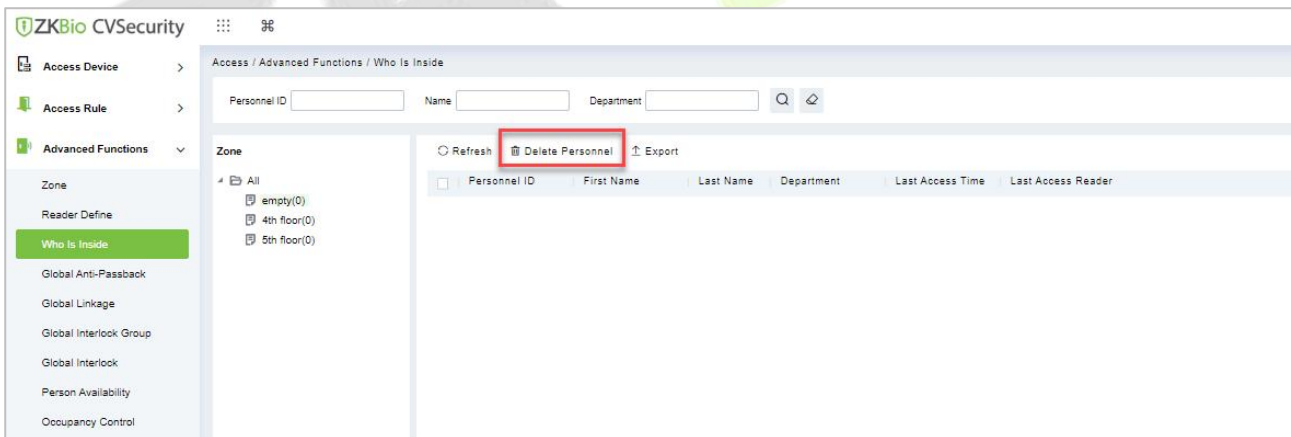

Figure 3- 105 Delete Who Is Inside

3.5.3.2 Export

Device information can be exported in EXCEL, PDF, CSV file format.

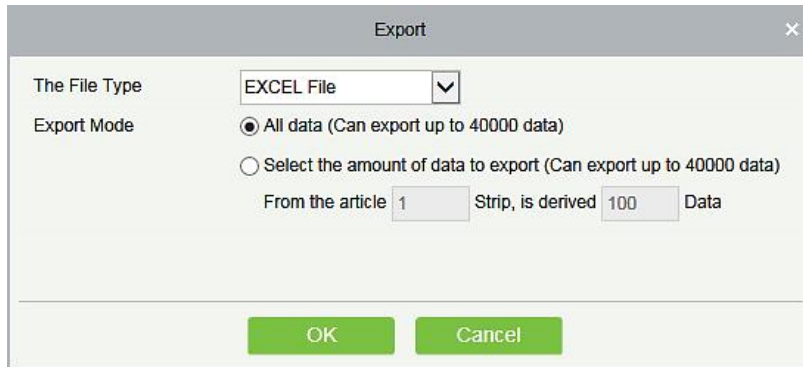

Figure 3- 106 Export

ZKTECO Device										
Device Name	Serial Number	Area Name	Communication Type	Network Connection Mode	IP Address	RS485 Parameter	Enable	Device Model	Register device	Firmware Version
192.168.218.60	20100501099	Area Name	HTTP	Wired	192.168.218.60		Enable	C3-400Pro		AC Ver 4.7.7.3033 Jun 16 2017

Figure 3- 107 Export Who is Inside

3.5.4 Global Anti-Passback

Global Anti-Passback Settings can be carried out across devices, and only push devices support global Anti-Passback functions. This function supports logical Anti-Passback, timed Anti-Passback and timed logical Anti-Passback, and can be configured for specific personnel.

This section describes the Step configuration of global Anti-Passback in ZKBio CVSecurity.

The Premise Condition:

1. Background authentication has been enabled on the device.
2. Set the access control area and read head definition.

3.5.4.1 Add (New)

Operation Step:

Step 1: In the **Access Control** module, choose "**Advanced Access Control > Global Anti-Passback**" and Click **New**.

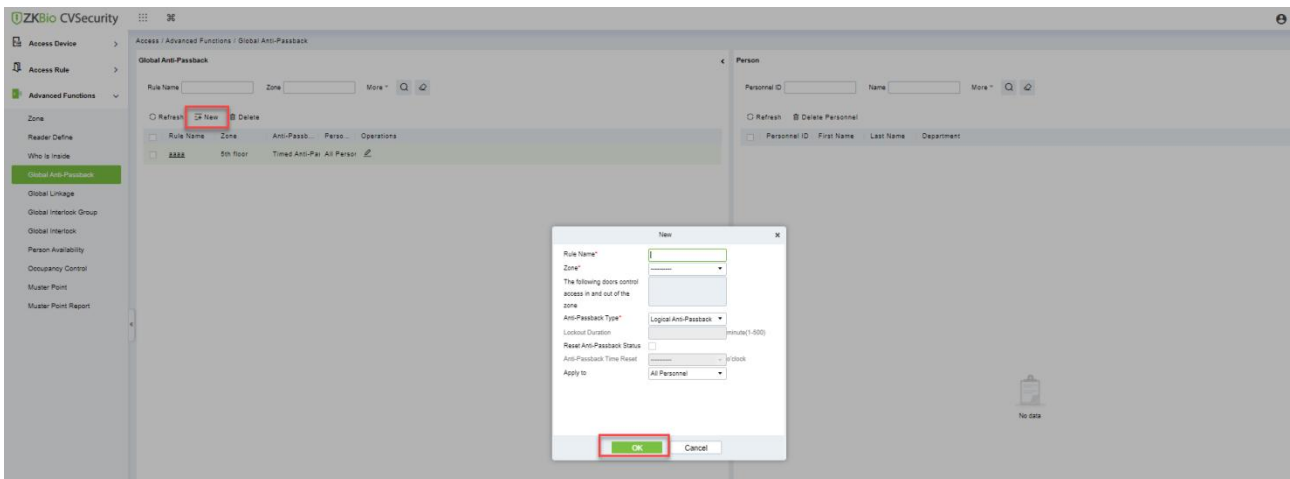

Figure 3- 108 Add Global Anti-Passback

Step 2: On the page for adding global Anti-Passback Settings, set related parameters and click **OK**, as shown in Figure 3-102. For parameter description, see Table 3-16.

Parameter	Description
Rule Name	The value can contain a maximum of 30 characters.
Entrance Guard Area	Select an option from the access control area drop-down list box.
The Door List Controls Access to The Access Control Area	The corresponding door information is displayed. The same gate shall not be used to control two independent Anti-Passback boundaries.
Anti-Passback Type	<p>It contains three types of Anti-Passback: logic Anti-Passback, timing Anti-Passback and timing logic Anti-Passback.</p> <p>instructions</p> <p>Logical Anti-Passback: strictly follow the "one in, one out" rule in the Anti-Passback area, otherwise the verification will not open</p> <p>Timed Anti-Passback: A user can enter the Anti-Passback area only once within a specified period of time. After the specified period expires, the user's status will be cleared and the user can enter the Anti-Passback area again</p> <p>Timed logical Anti-Passback: the user can open the door normally only after following the exit and entry rules of logical Anti-Passback. Timing logic antisubmarine is only used in abnormal situations. For example: if the logical Anti-Passback time is set and the personnel follows others out, the personnel cannot swipe the card machine within the set locking time. The Anti-Passback state will be reset after the set locking time, and the traffic can continue.</p>
The Locking Time	You can set the locking period only when you select timing Anti-Passback or logic Anti-Passback type.
Reset Global Anti-Passback Status	Clear the Anti-Passback status of personnel in the system and restore the initialization status.
Reset Anti-Passback Time	<p>The reset time can be selected only when reset global Anti-Passback status is selected.</p> <p>When it is time to reset Anti-Passback, the system will automatically clear the Anti-Passback status of all personnel in the access control area.</p>
Applied	<p>All personnel, selected personnel, except selected personnel three types:</p> <p>instructions</p> <p>All personnel: This type can only be edited. Personnel selection is not supported</p> <p>Selected Personnel: If you select this type, you can add personnel. This Anti-Passback type takes effect only for these personnel.</p> <p>Personnel other than selected: Select this type, add personnel, this Anti-Passback type will only take effect for personnel other than selected.</p>

Table 3- 16 Global Anti-Passback Settings

3.5.4.2 Delete

In the **Access > Advanced Functions > Global Anti-Pass**, click **Delete** button under Operations. Click **OK** to delete.

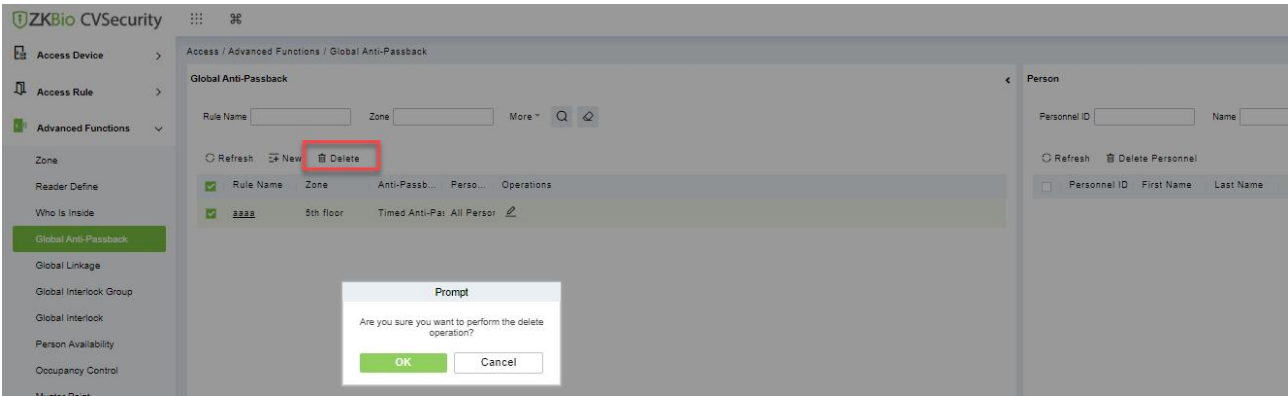

Figure 3- 109 Delete Global Anti-Passback

3.5.5 Global Linkage

The global linkage function can be set across devices. Only the push device supports the global linkage function

This section describes how to configure Step for global linkage in ZKBio CVSecurity.

3.5.5.1 Add (New)

Operation Step:

Step 1: In the **Access Control** module, choose **“Advanced Functionl > Global Linkage”** and Click **New**.

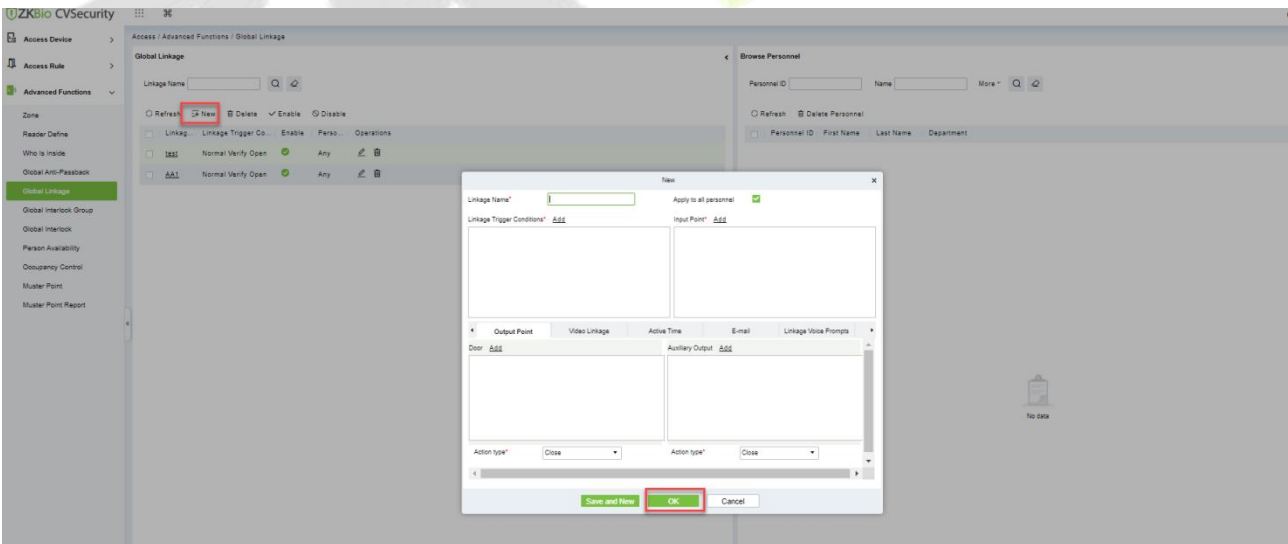

Figure 3- 110 Add Global Linkage

Step 2: On the page for adding global linkage, set related parameters and tap **OK**, as shown in Figure 3-104. Table 3-17 describes the parameter description to complete global linkage Settings.

Parameter	Operation Instructions
Linkage Name	You can customize the linkage name for easy query
It Works for Everyone	After this parameter is selected, the linkage Settings take effect on all personnel

Parameter	Operation Instructions
Linkage Trigger Condition	Select the condition triggered by the linkage Operation, that is, the event type generated by the selected device
Input Point	Select the input point to set device input
Dots	Select the output point to set device output Set the output action type: close, open, normally open. Sets the delay time if the output action is on.
Video Linkage	Pop-up video and display duration: Select pop-up video on the real-time monitoring screen and set the pop-up duration. Video recording and Video Duration: Select Video recording to set the video duration. Capture: Set linkage action whether to take a photo: If a photo is taken, you also need to set whether to pop up on the real-time monitoring interface and the display duration.
Valid Time	The reset time can be selected only when reset global Anti-Passback status is selected When it is time to reset Anti-Passback, the system will automatically clear the Anti-Passback status of all personnel in the access control area.
Mail	Set the email address that receives the linkage content when a linkage event occurs

Table 3-17 Global Linkage Parameters

Apply to all personnel: If this option is selected, this linkage setting is effective for all personnel.

Active Time: Set the active time of the linkage setting.

Step 3: Choose Global Linkage trigger conditions, the input point (System will filter devices according to the choice in first step) and the output point, Set up linkage action. For more details about these parameters, please refer to Linkage Setting.

Note: You can select multiple Door Events, but “Fail to connect server”, “Recover connection” and “Device connection off” will be filtered automatically from Door Event.

Step 4: Click **OK** to save and quit. The added Global Linkage will display in the list.

3.5.5.2 Delete

In the **Access > Advanced Functions > Global Linkage**, click **Delete** button under Operations. Click **OK** to delete.

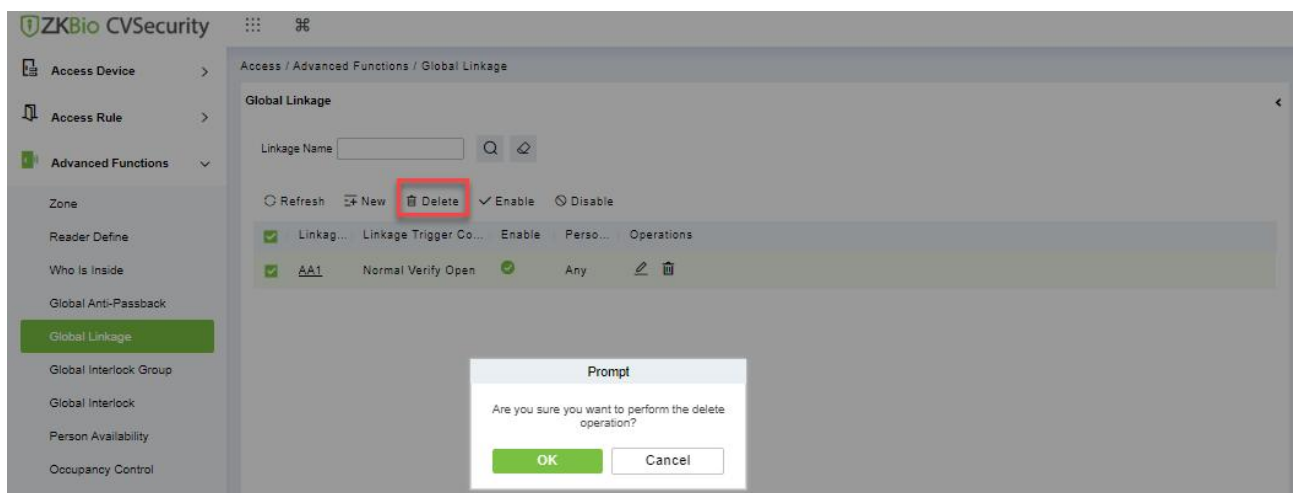

Figure 3- 111 Delete Global Linkage

3.5.5.3 Enable

After the device is enabled, the upload and download of data are enabled normally. (When the device is enabled, users can choose whether it is a registration device or not).

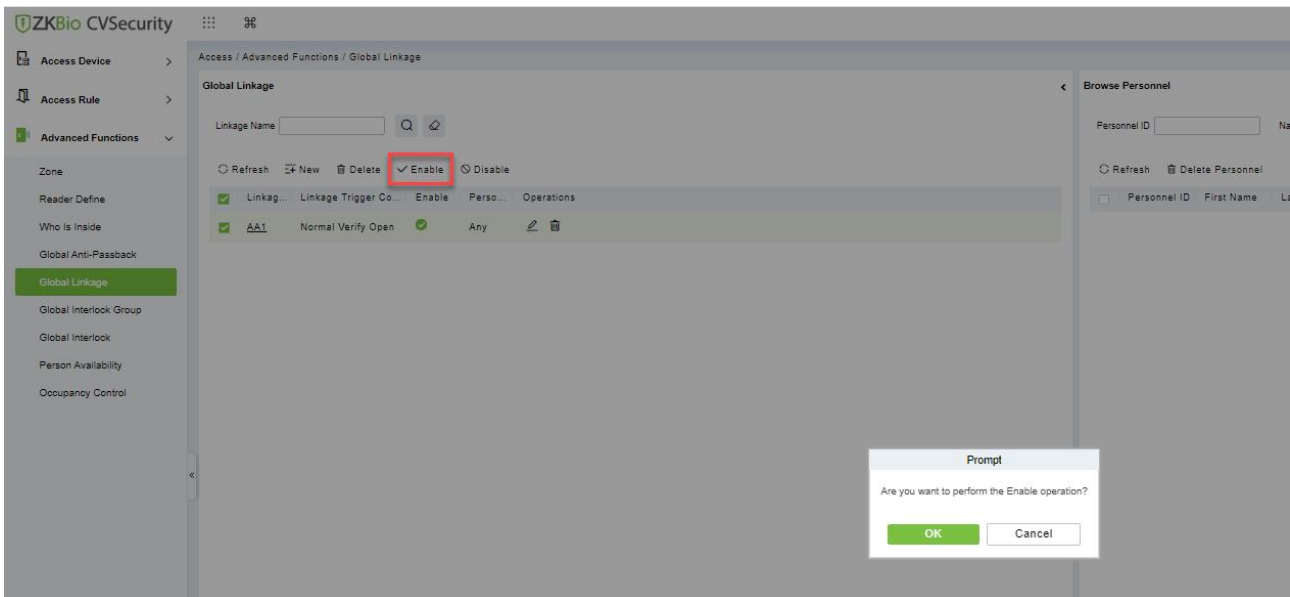

Figure 3- 112 Enable Global Linkage

3.5.5.4 Disable

After the device is disabled, the device is not allowed to upload and send data.

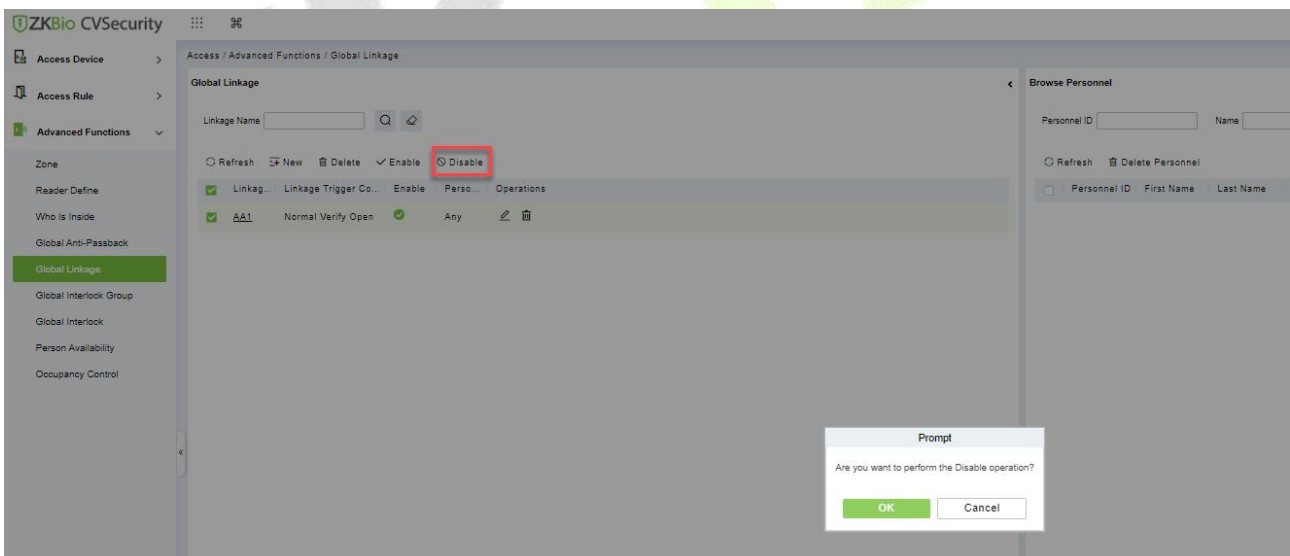

Figure 3- 113 Disable Global Linkage

3.5.6 The Global Interlock Group

Global interlocking the global interlocking function can be set across devices. Only the push device supports global interlocking. By setting the global interlock group to group doors, you can set global interlock.

This section describes the Step configuration of global interlock in ZKBio CVSecurity.

The Premise Condition:

Background authentication has been enabled on the device.

3.5.6.1 Add (New)

Operation Step:

Step 1: In the **Access Control** module, choose “**Advanced Access Control > Global Interlock Group**” and Click **New**.

Step 2: On the page for adding a global interlock group, set related parameters and Click **OK**, as shown in Figure 3-93.

Figure 3- 114 Global Interlock Group Settings Screen

Parameter	How to set up
Group Name	Any combination of up to 30 characters that cannot be identical to an existing group name
Group Interlock	Select the configured interlock rule.

Table 3-18 Description of Advance Global Interlock

Step 3: On the global interlock group page, tap Add Door next to the configured group name on the left, as shown in Figure 3-94.

Figure 3- 115 Adding A Door to A Global Interlock Group

3.5.6.2 Delete

In the **Access > Advanced Functions > Global Interlock Group**, click **Delete** button under Operations. Click **OK** to delete.

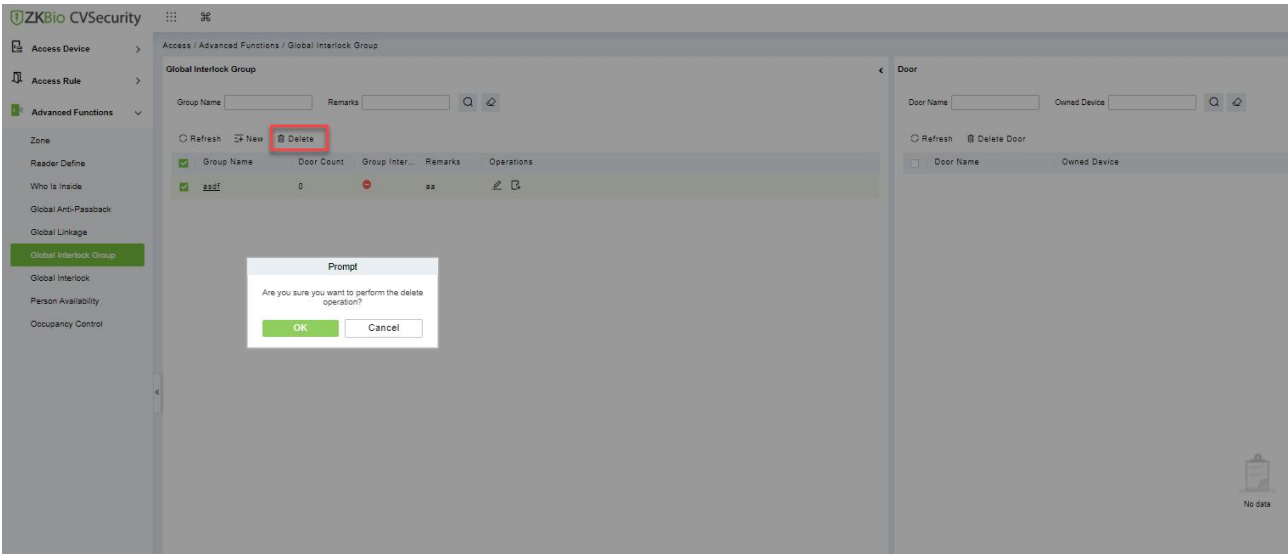

Figure 3- 116 Delete A Door to A Global Interlock Group

3.5.7 The Global Interlock

3.5.7.1 Add (New)

Step 1: In the **Access Control** module, choose **“Advanced Access Control > Global Interlock”** and Click **New**.

On the page for adding global interlock, set related parameters and Click **OK**, for example

Step 2: The global interlock name is set.

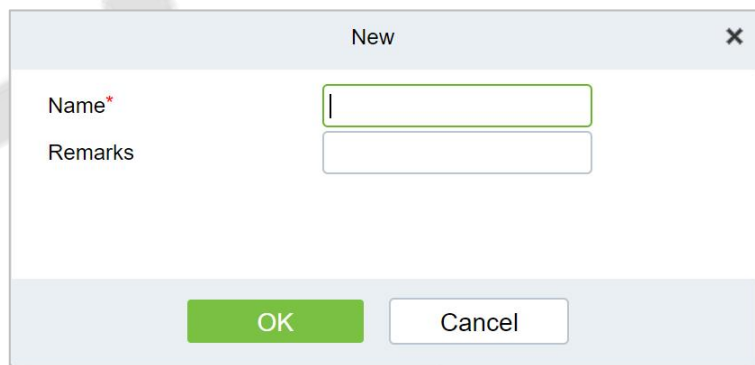

Figure 3- 117 Global Interlock Settings Screen

Parameter	How to set up
Name	Any combination of up to 30 characters that cannot be identical to an existing name
Remark	Select the configured interlock rule.

Table 3- 17 Description of Access Control Right Groups

Step 3: On the global interlock screen, click **Add** Group next to the configured global interlock on the left, as shown in Figure 3-112.

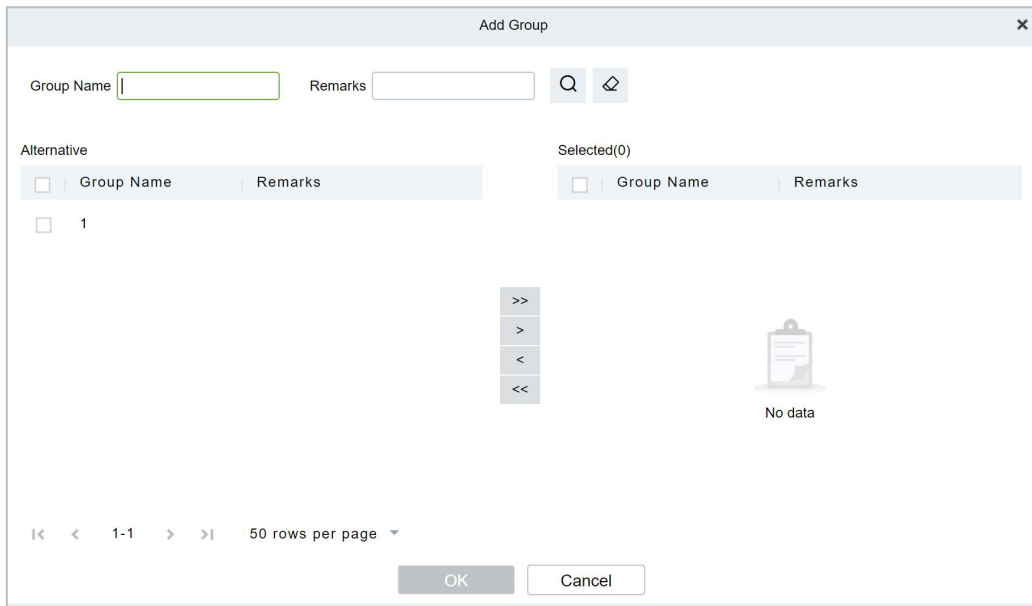

Figure 3- 118 Page for Adding Global Interlock Groups

3.5.7.2 Delete

In the **Access > Advanced Functions > Global Interlock**, click **Delete** button under Operations. Click **OK** to delete.

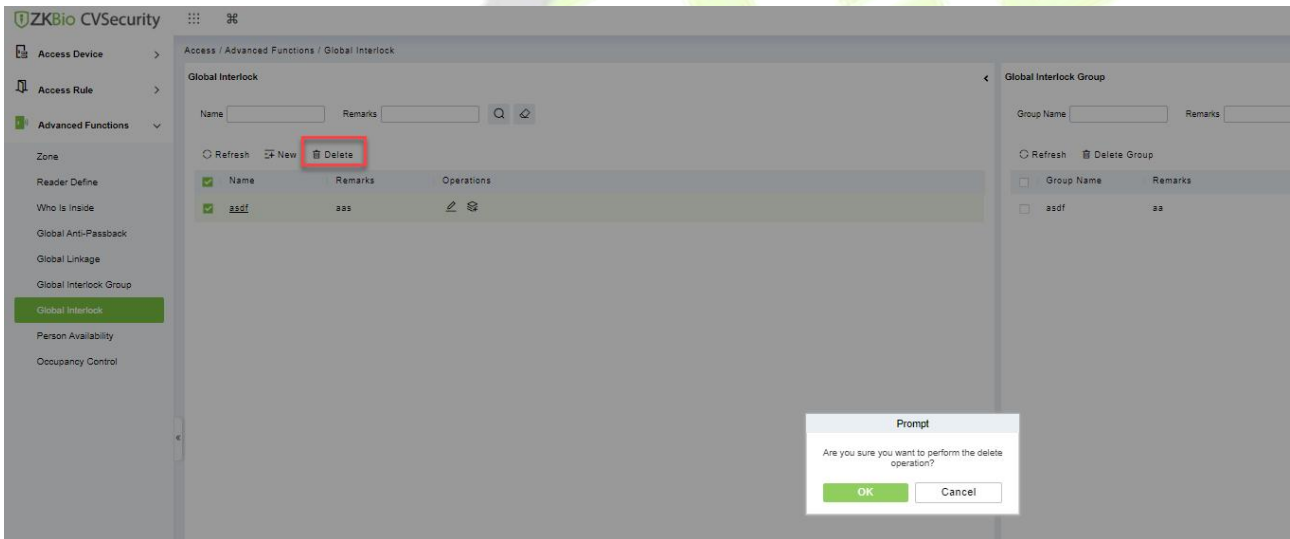

Figure 3- 119 Page for Adding Global Interlock Groups

3.5.8 Personnel Availability

It is used to restrict the expiration date, the number of days after the first use, and the number of times the user passes the specified advanced access control area.

The Premise Condition:

1. Background authentication has been enabled on the device
2. Set the access control area and read head definition.

3.5.8.1 Add (New)

Operation Step:

Step 1: In the **Access Control** module, choose “**Advanced Access Control >Personnel Availability>Set Access Control Area Properties**”, and Click **New**.

Step 2: On the **Access Control Area Properties** page, set related parameters and Click **OK**.

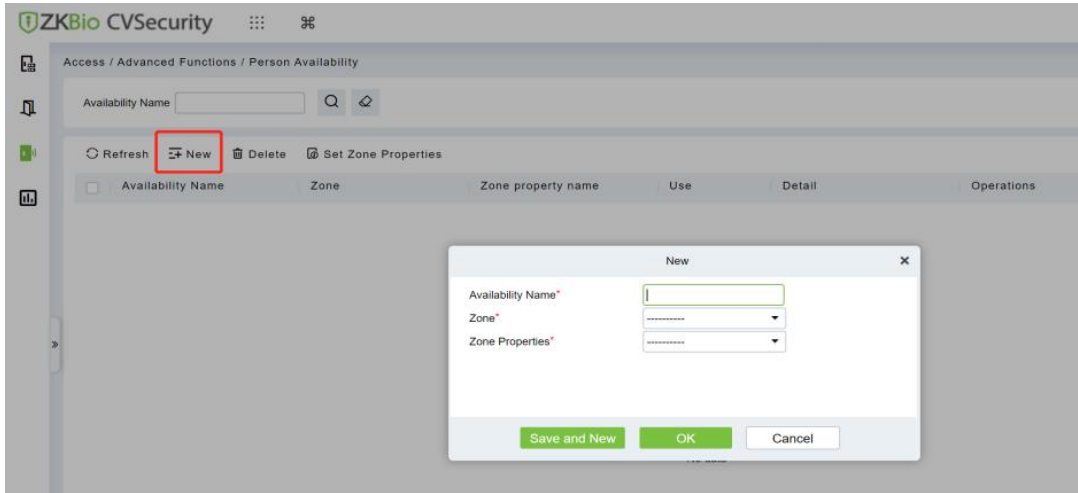

Figure 3- 120 Page for Setting Access Area Properties

Step 3: In the properties of the **access control area** that has been set, click **Add Personnel** on the left to add the corresponding personnel, and Click **OK**.

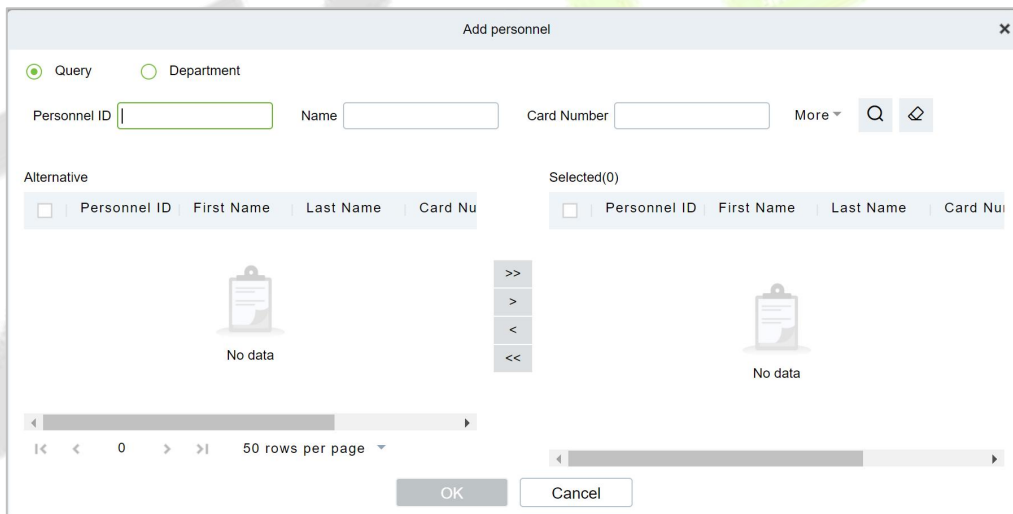

Figure 3- 121 Personnel Availability Add Personnel Settings Screen

Step 4: On the personnel validity screen, tap **Add**, set related parameters, and tap **OK**.

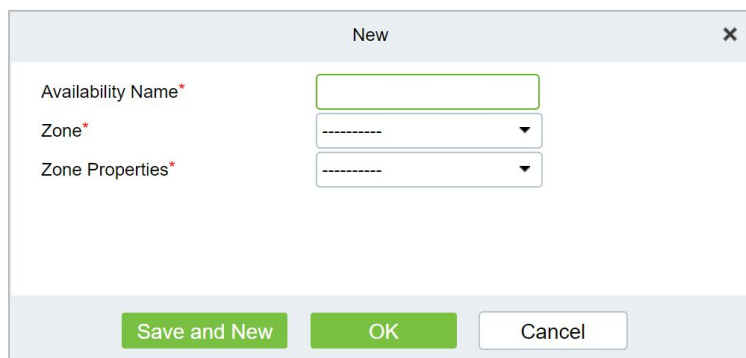

Figure 3- 122 Personnel Validity Setting Screen

3.5.8.2 Delete

In the **Access > Advanced Functions > Personnel Availability**, click **Delete** button under Operations. Click **OK** to delete.

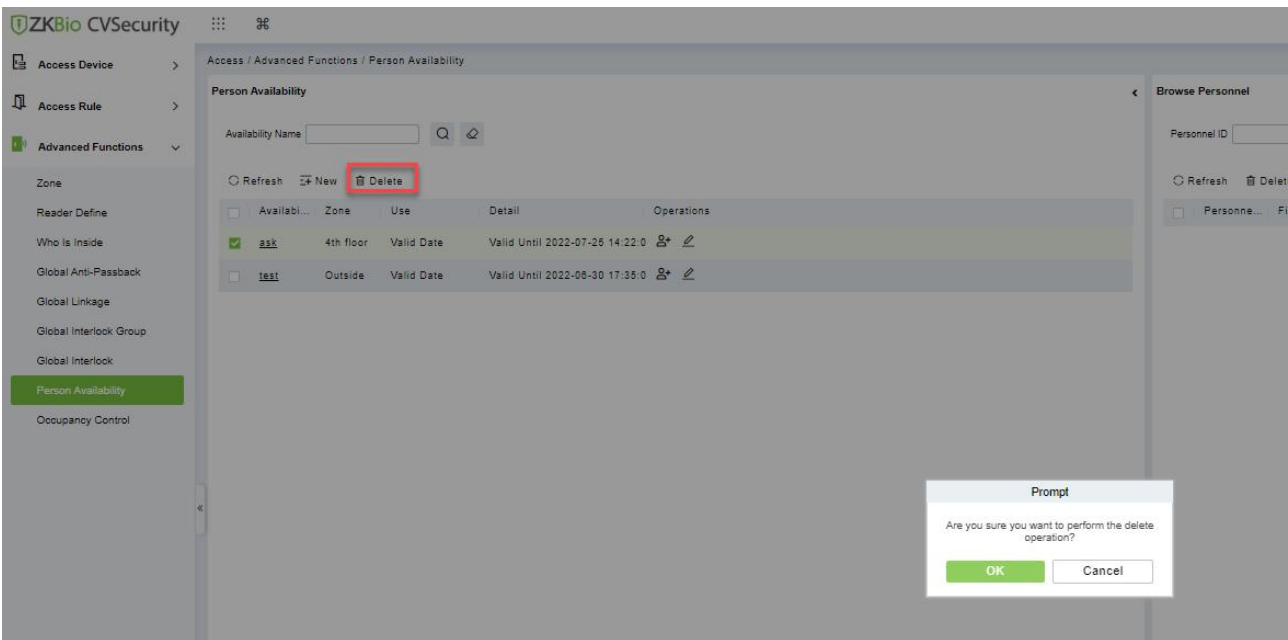

Figure 3- 123 Delete Personnel Validity Setting

3.5.9 Occupancy Control

Control the maximum/minimum capacity of the area in the Advanced Access Control. This section describes the Step configuration for population control in ZKBio CVSecurity.

The Premise Condition

1. Background authentication has been enabled on the device.
2. Set the access control area and read head definition.

3.5.9.1 Add (New)

Operation Step

Step 1: In the **Access Control** module, choose "**Advanced Function > Occupancy**" and Click **New**.

Step 2: On the Add Person control screen, set related parameters and click **OK**.

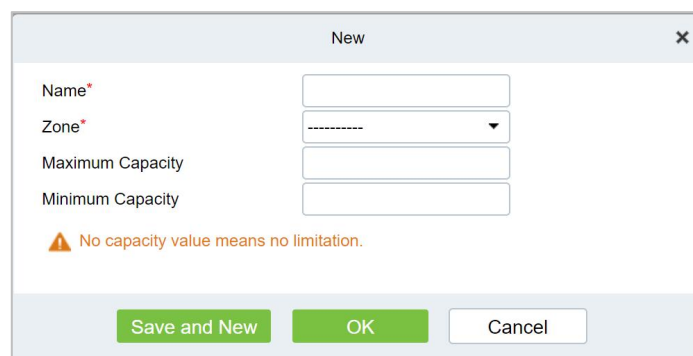

Figure 3- 124 Configuring the People Counting Function

3.5.9.2 Delete

In the **Access > Advanced Functions > Occupancy Control**, click **Delete** button under Operations. Click **OK** to delete.

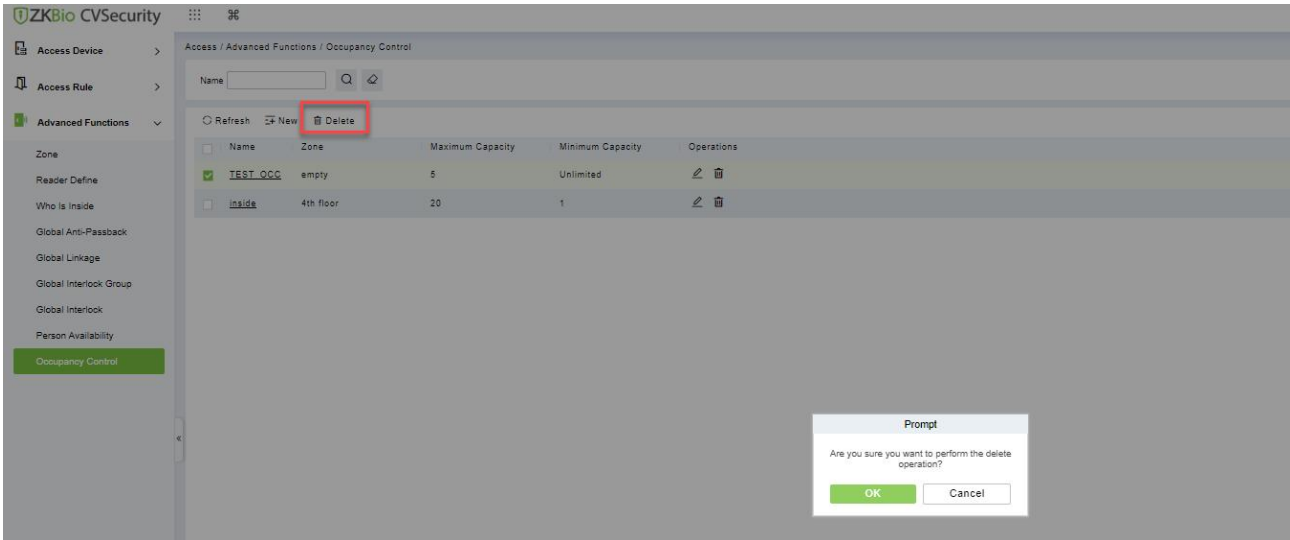

Figure 3- 125 Delete Configuring the People Counting Function

3.5.10 Muster Point

Designate the access control device of a certain place as the Muster Point. When an emergency event (such as a fire alarm) occurs, the linkage triggers the activation of the Muster Point to open the door, and the AC Device is used to count the escape of personnel, and quickly identify the escaped personnel and dangerous personnel.

3.5.10.1 Add (New)

Select the access control devices as the equipment of Muster Point, and assign the corresponding department. Note: The equipment selected is equipped with safe house conditions to facilitate evacuation of personnel in the department.

Operation Steps:

Step 1: Set device as Muster Point, go to **“Access Control > Advanced Functions > Muster Point > New: Sign device to the point”**.

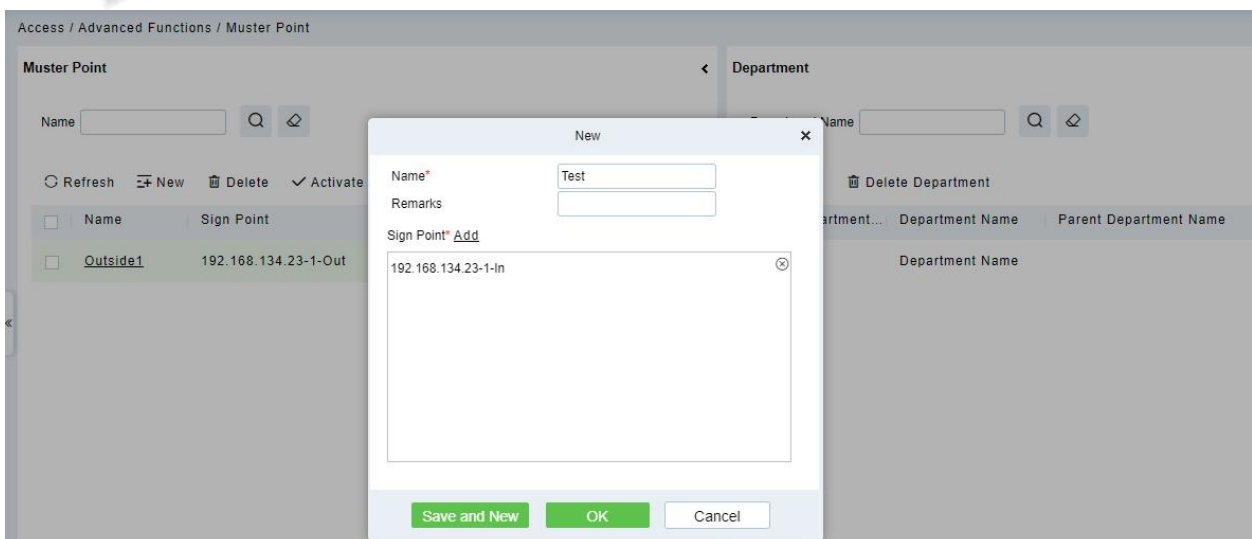



Figure 3- 126 Sign Point

Step 2: Click  add department to the point.

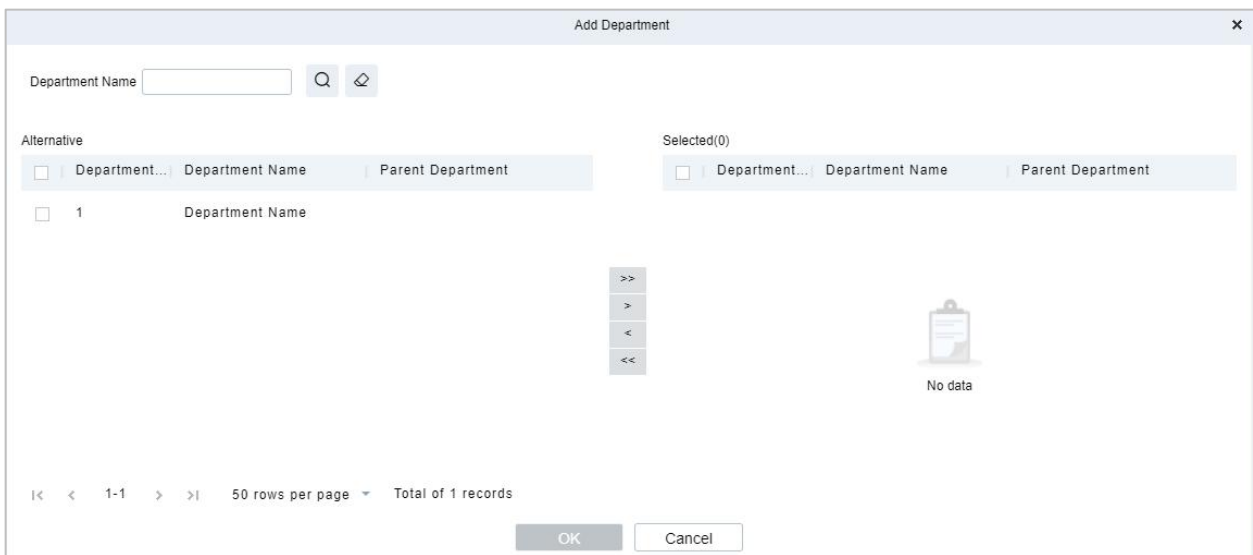

Figure 3- 127 Add Department

Step 3: Set Global Linkage: set Linkage Trigger Conditions and Input Point, Selete Muster Point as an output action.

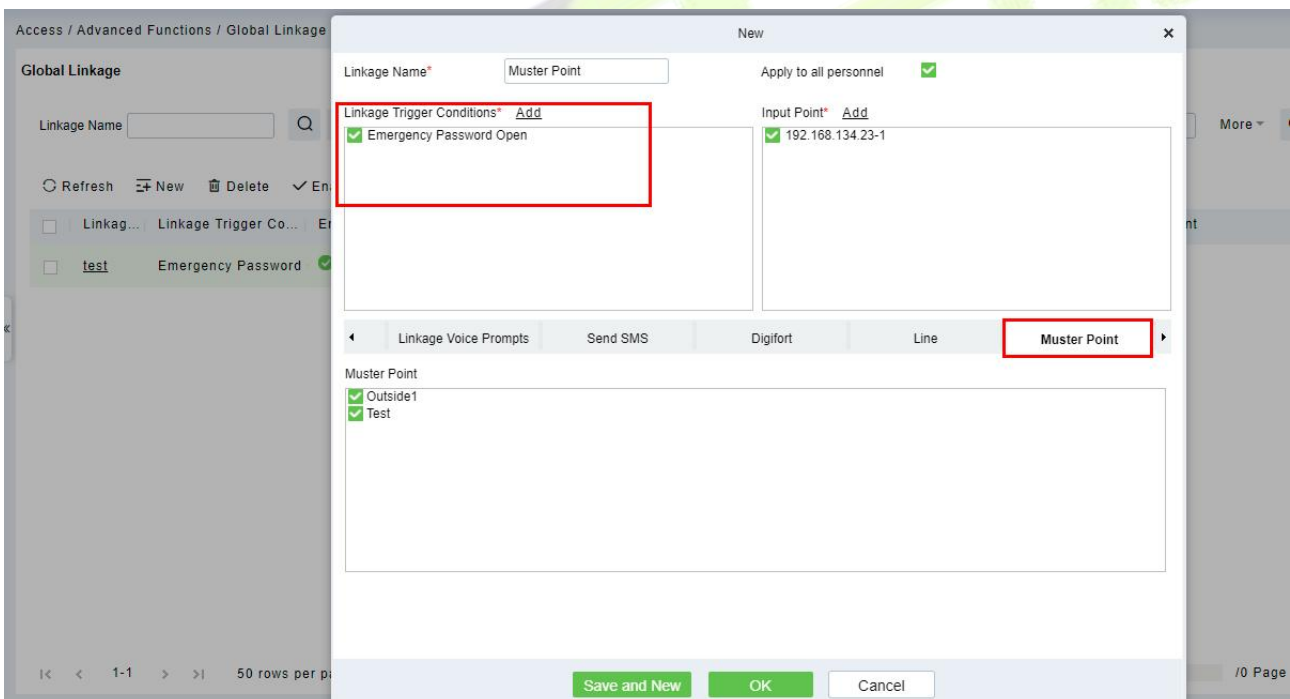

Figure 3- 128 Global Linkage

Note: Before you use global linkage, you must confirm that your device has enable background authentication.

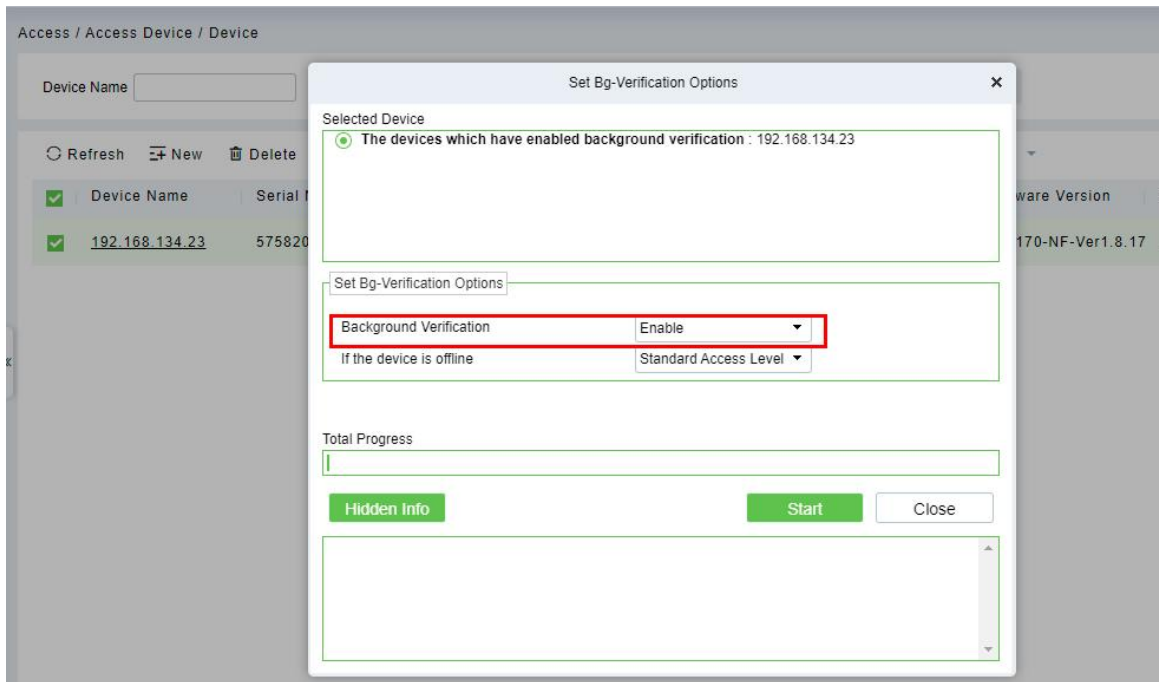

Figure 3- 129 Enable Bg-Verification Options.

3.5.10.2 Activated

When the linkage event is triggered, the door is opened remotely, and the Muster Point would be activated.

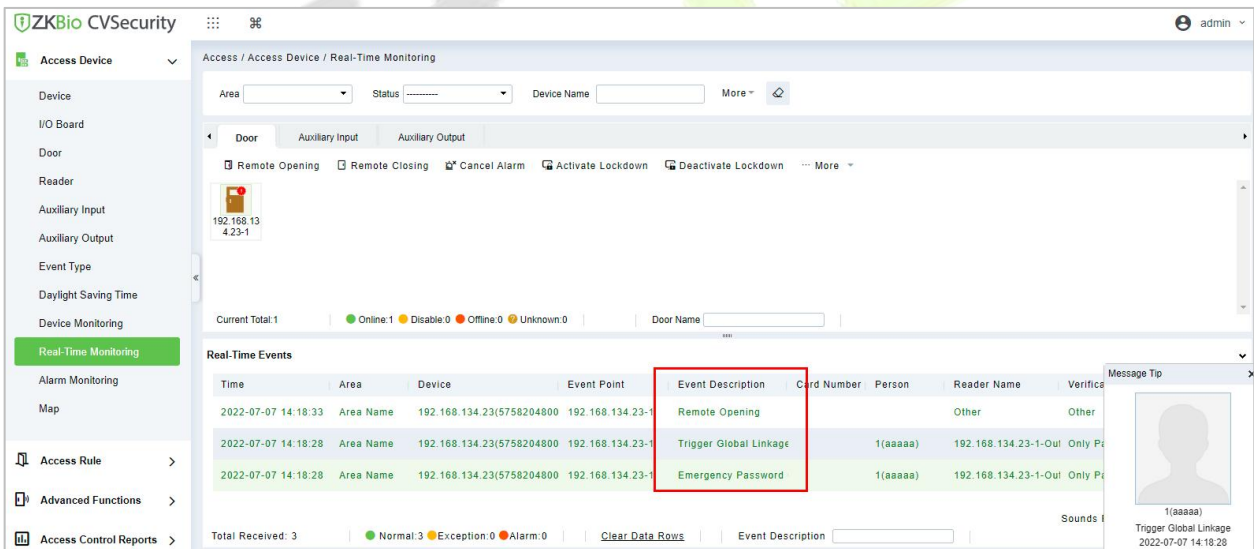

Figure 3- 130 Real-Time Monitoring

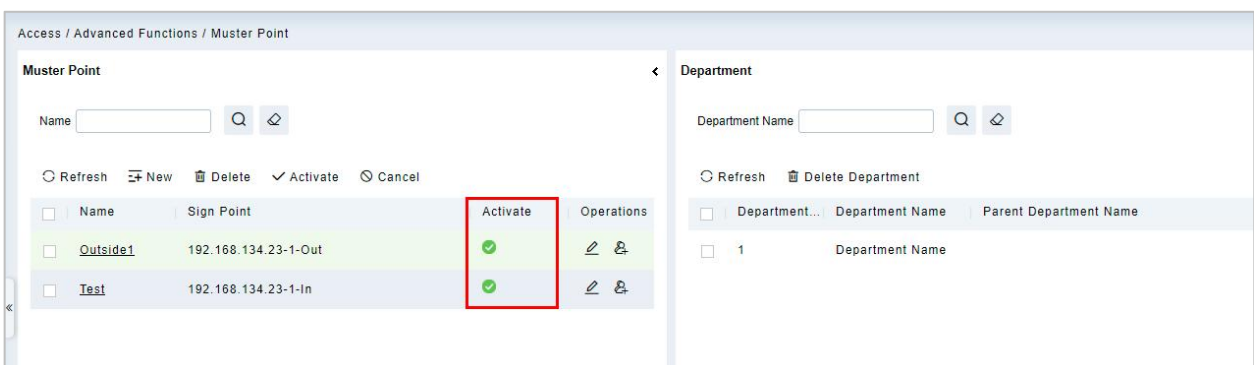

Figure 3- 131 Muster Point

3.5.10.3 Delete

In the **Access > Advanced Functions > Muster Point**, click **Delete** button under Operations. Click **OK** to delete.

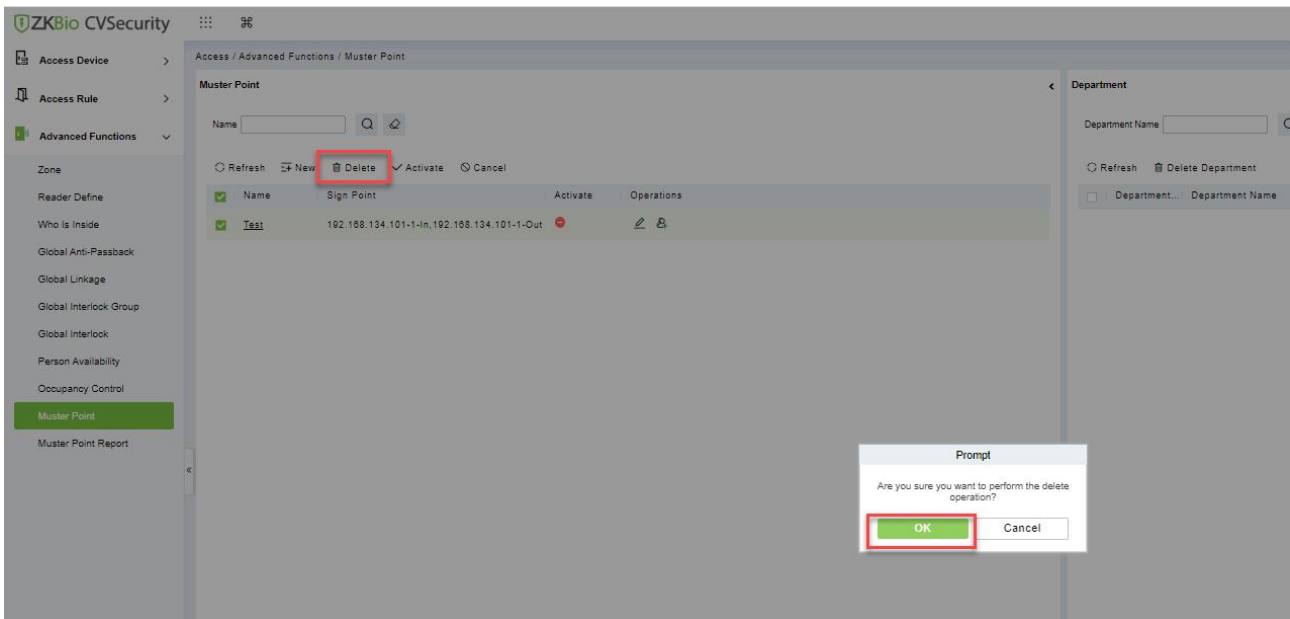

Figure 3- 132 Delete Muster Point

3.5.10.4 Cancel

In the **Access > Advanced Functions > Muster Point**, click **Cancel** button under Operations. Click **OK** to cancel.

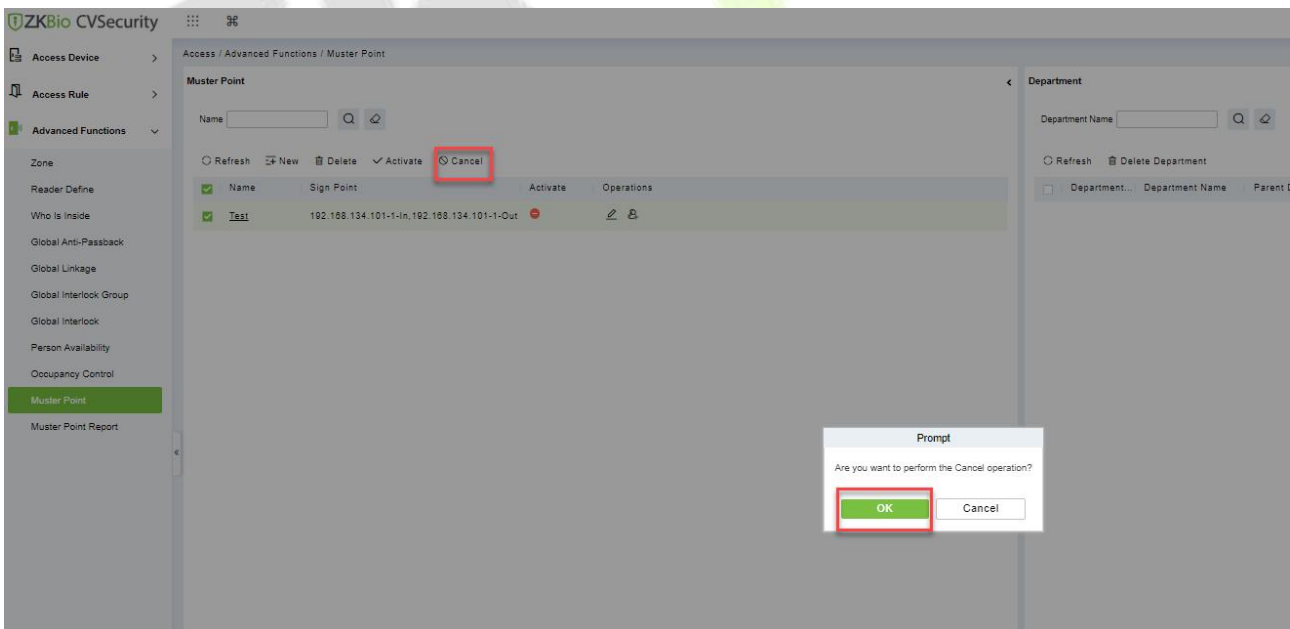

Figure 3- 133 Cancel Muster Point

3.5.11 Muster Point Setting

Select the access control devices as the equipment of Muster Point and assign the corresponding department. Note: The equipment selected is equipped with safe house conditions to facilitate evacuation of personnel in the department.

Operation Steps:

Step 1: Set device as Muster Pointsetting, go to **“Access Control > Advanced Functions > Muster Point Setting”**.



Figure 3- 134 Check the Report

3.5.11.1 Sign In Manually

If someone is not verified on the device, the administrator can manually sign in: Select **Sign in Manually**, see the picture below.

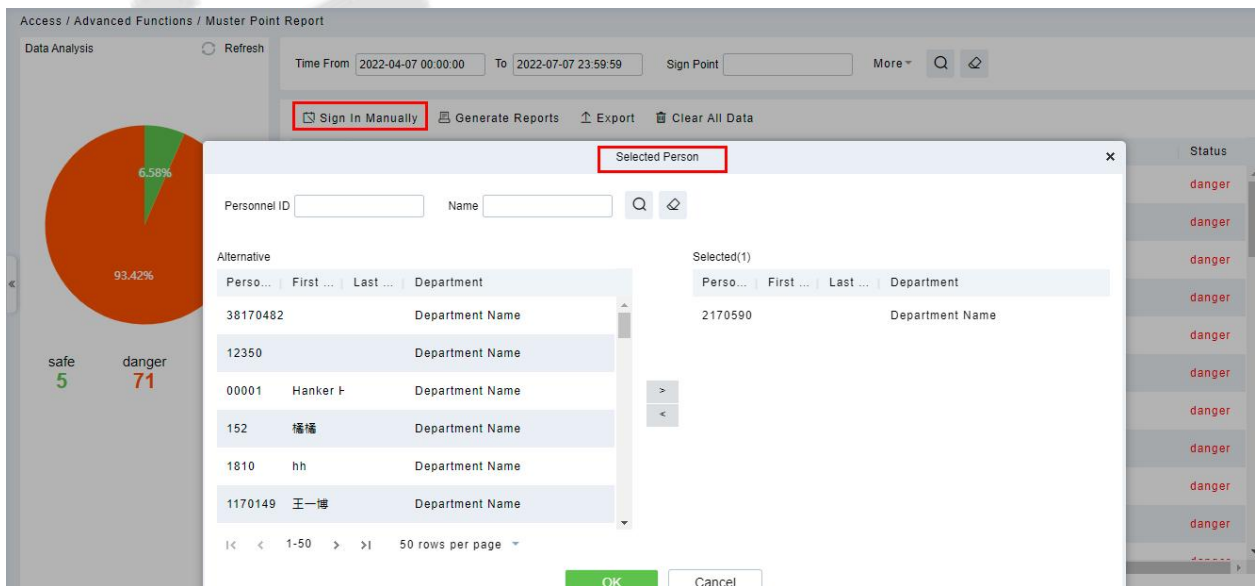

Figure 3- 135 Sign in Manually

Check the statuses will change to “safe”.

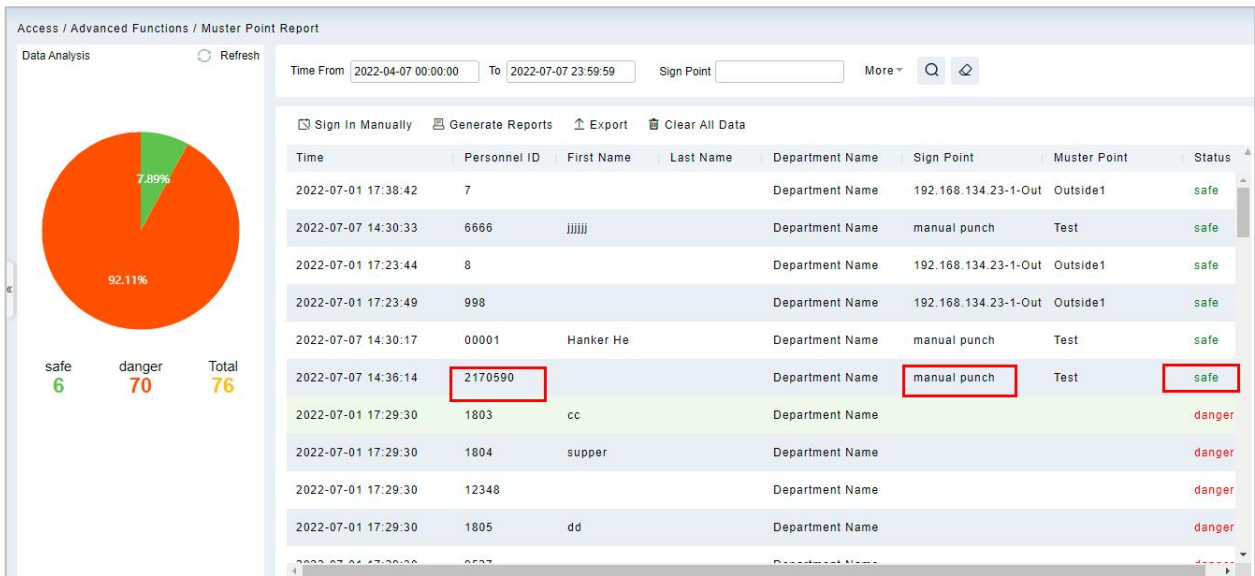

Figure 3- 136 Sign in Manually

3.5.11.2 Generate Reports

Click **“Generate Reports”** to check the reports.the report format: Excel/PDF/CVS/TXT that you can selete.

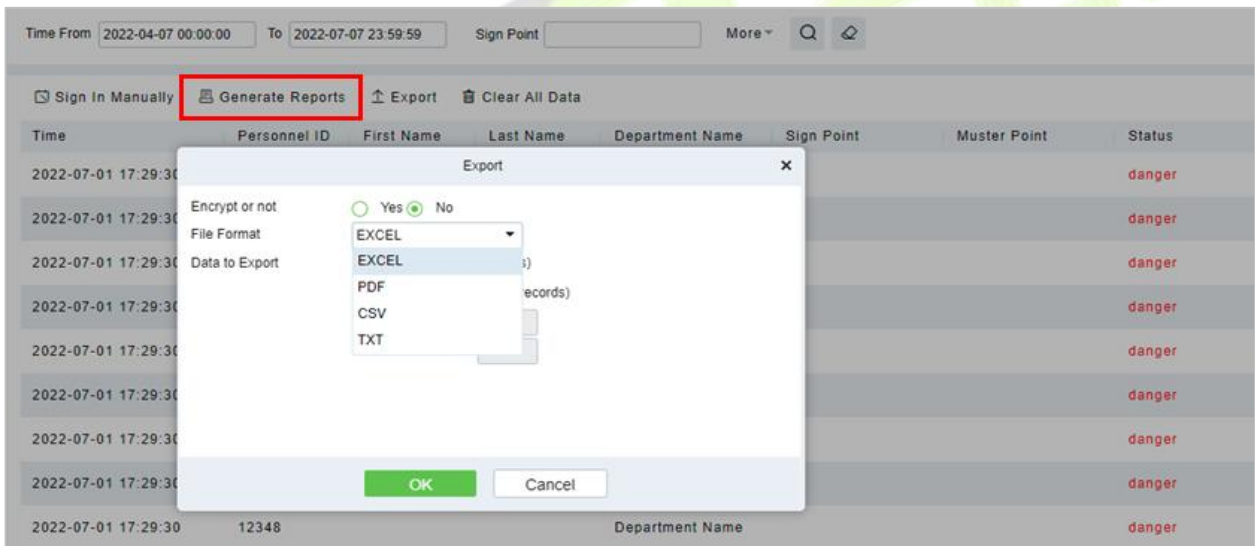

Figure 3- 137 Download Report

Muster Point Report							
Time	Personnel ID	First Name	Last Name	Department Name	Sign Point	Muster Point	Status
2022-07-01 17:29:30	1801	aa		Department Name			danger
2022-07-01 17:29:30	12347			Department Name			danger
2022-07-01 17:29:30	12346			Department Name			danger
2022-07-01 17:29:30	1802	bb		Department Name			danger
2022-07-01 17:29:30	17014	xa		Department Name			danger
2022-07-01 17:29:30	12349			Department Name			danger
2022-07-01 17:29:30	1803	cc		Department Name			danger
2022-07-01 17:29:30	1804	supper		Department Name			danger
2022-07-01 17:29:30	12348			Department Name			danger
2022-07-01 17:29:30	1805	dd		Department Name			danger
2022-07-01 17:29:30	9527			Department Name			danger
2022-07-01 17:29:30	156456456	啾啾啾		Department Name			danger
2022-07-01 17:29:30	1806	ee		Department Name			danger
2022-07-01 17:29:30	10002	李长文		Department Name			danger
2022-07-01 17:29:30	12345			Department Name			danger
2022-07-01 17:29:30	1807	sup		Department Name			danger
2022-07-01 17:29:30	1010101	Anni 哈哈哈哈哈		Department Name			danger
2022-07-01 17:29:30	202201171	kk		Department Name			danger
2022-07-01 17:29:30	1010102			Department Name			danger
2022-07-01 17:29:30	666	chen		Department Name			danger
2022-07-01 17:29:30	12345			Department Name			danger
2022-07-01 17:29:30	2262	影		Department Name			danger
2022-07-01 17:29:30	22222	ooco		Department Name			danger
2022-07-01 17:29:30	130303			Department Name			danger

Figure 3- 138 Report

3.5.11.3 Clear All Data

In the **Access > Advanced Functions > Muster Point Setting**, click **Clear All Data** button under Operations. Click **OK** to clear all data.

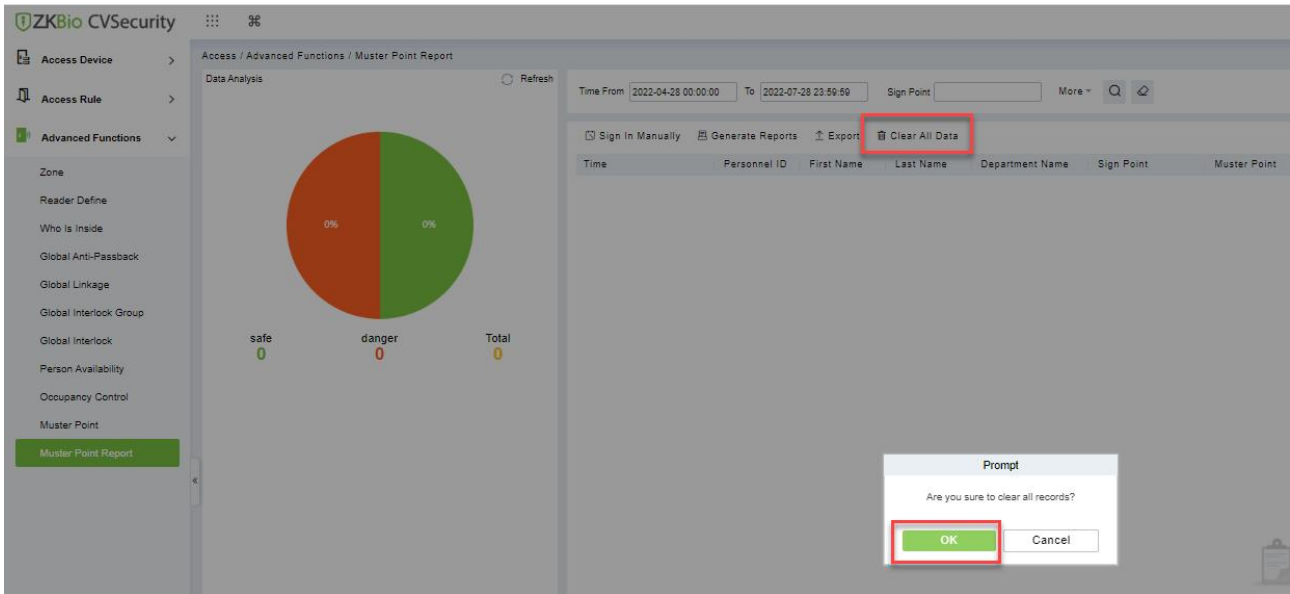

Figure 3- 139 Clear All Data

3.5.11.4 Export

On the All Records screen, click Export, enter the user password in the displayed security verification dialog box, and Click **OK**. Select whether to encrypt the file and the file format to export, and click **OK**.

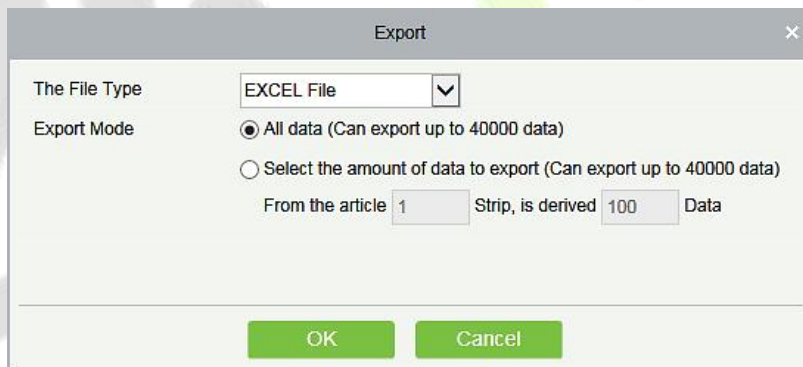

Figure 3- 140 Export

ZKTECO Device										
Device Name	Serial Number	Area Name	Communication Type	Network Connection Mode	IP Address	RS485 Parameter	Enable	Device Model	Register device	Firmware Version
192.168.218.80	20100501999	Area Name	HTTP	Wired	192.168.218.80		Enable	C3-400Pro		AC Ver 4.7.7.3033 Jun 16 2017

Figure 3- 141 Export

3.6 Access Control Reports

In the access control report, you can query all access control records, including All records, Today's Access records, All abnormal records, door query, personnel query and Personnel access records reports. You can export all records or query records.

This section describes the Step for querying and exporting reports in ZKBio CVSecurity.

3.6.1 All Transactions

Operation Step

Step 1: In the **Access Control** module, choose **“Access Control Report > All Records”**.

Step 2: On the All Records interface, fill in the corresponding query information and click the “search” symbol to complete the query of all records, as shown in Figure 3-120.



Figure 3- 142 Report Query Page

Step 3: On the All Records screen, click Export, enter the user password in the displayed security verification dialog box, and Click **OK**. Select whether to encrypt the file and the file format to export, and Click **OK**.

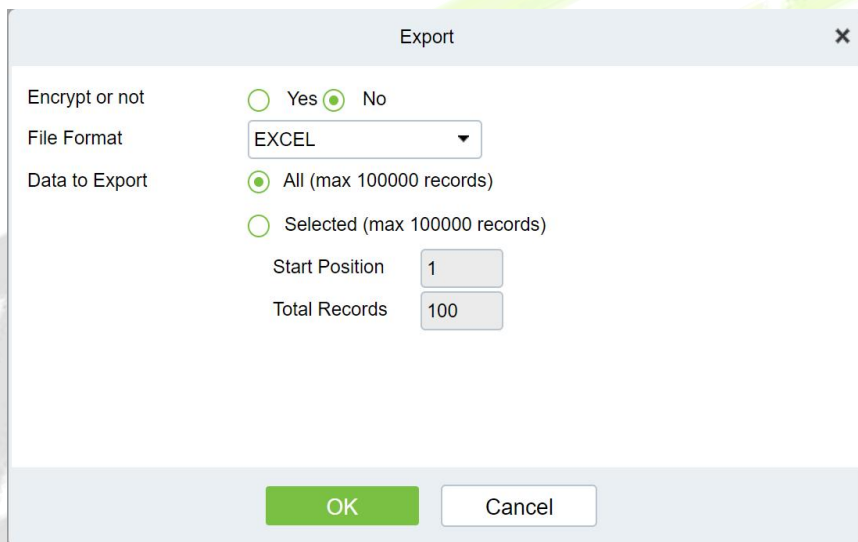

Figure 3- 143 Report Export Page

Step 4: You can export the file by selecting the address for storing the file.

Media File: You can view or download the photos and videos created in the video system.

Clear All Data: Click **Clear All Data** to pop up prompt and click **OK** to clear all transactions.

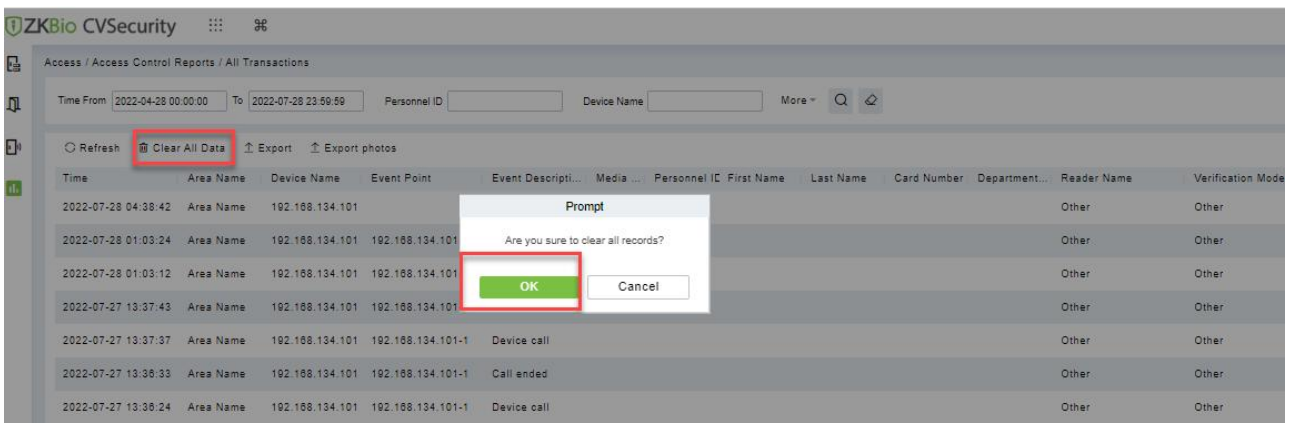

Figure 3- 144 Report Clear All Data

3.6.2 Events from Today

Check out the system record today.

Click **Access Control Reports > Events from Today** to view today's records. You can export all events from today in Excel, PDF, CSV format.

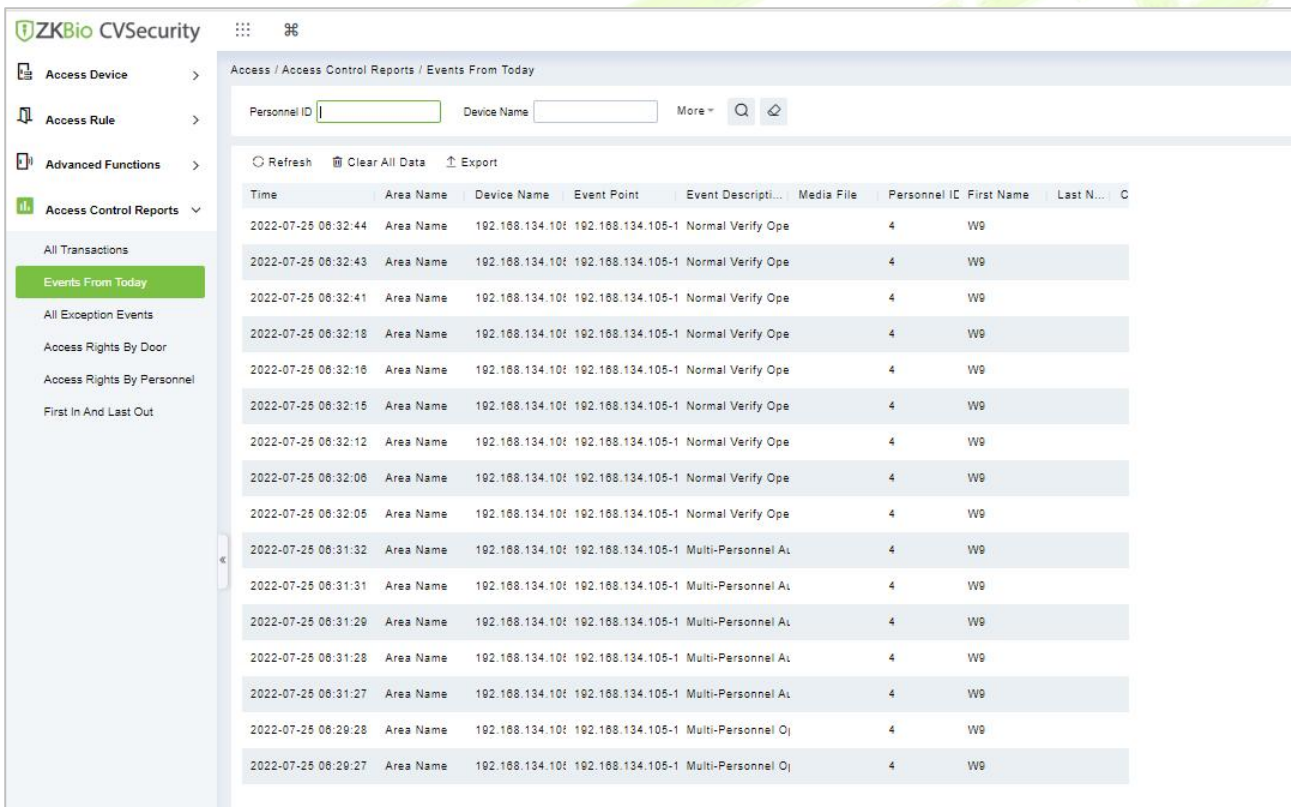

Figure 3- 145 Event from Today

Click Export, enter the user password in the displayed security verification dialog box, and Click **OK**. Select whether to encrypt the file and the file format to export, and Click **OK**.

ZKTECO												
Events From Today												
Time	Card Number	Personnel ID	First Name	Last Name	Department Name	Device Name	Event Point	Event Description	Reader Name	Verification Mode	Area Name	Remark
2017-12-15 18:29:02	4628036	0	Amber	Lin	Financial Department	192.168.218.60	192.168.218.60-2	Background Verify Success	192.168.218.60-2-In	Only Card	Area Name	
2017-12-15 18:28:59	4628036	0	Amber	Lin	Financial Department	192.168.218.60	192.168.218.60-1	Background Verify Success	192.168.218.60-1-In	Only Card	Area Name	
2017-12-15 18:28:45	13280079	5	Neool	Ye	Marketing Department	192.168.218.60	192.168.218.60-2	Background Verify Success	192.168.218.60-2-In	Only Card	Area Name	
2017-12-15 18:28:41	13280079	5	Neool	Ye	Marketing Department	192.168.218.60	192.168.218.60-1	Background Verify Success	192.168.218.60-1-In	Only Card	Area Name	
2017-12-15 18:28:38	4481253	1	Jerry	Wang	General	192.168.218.60	192.168.218.60-2	Background Verify Success	192.168.218.60-2-In	Only Card	Area Name	
2017-12-15 18:28:35	4481253	1	Jerry	Wang	General	192.168.218.60	192.168.218.60-1	Background Verify Success	192.168.218.60-1-In	Only Card	Area Name	
2017-12-15 18:28:23	1411237	2940	Sherry	Yang	Hotel	192.168.218.60	192.168.218.60-2	Background Verify Success	192.168.218.60-2-In	Only Card	Area Name	
2017-12-15 18:28:20	1411237	2940	Sherry	Yang	Hotel	192.168.218.60	192.168.218.60-1	Background Verify Success	192.168.218.60-1-In	Only Card	Area Name	
2017-12-15 18:28:17	9505930	9	Lilian	Mei	Development Department	192.168.218.60	192.168.218.60-2	Background Verify Success	192.168.218.60-2-In	Only Card	Area Name	
2017-12-15 18:28:13	9505930	9	Lilian	Mei	Development Department	192.168.218.60	192.168.218.60-1	Background Verify Success	192.168.218.60-1-In	Only Card	Area Name	
2017-12-15 18:28:06	13271770	3	Leo	Hou	Financial Department	192.168.218.60	192.168.218.60-2	Background Verify Success	192.168.218.60-2-In	Only Card	Area Name	
2017-12-15 18:28:01	13271770	3	Leo	Hou	Financial Department	192.168.218.60	192.168.218.60-1	Background Verify Success	192.168.218.60-1-In	Only Card	Area Name	
2017-12-15 18:23:52	4481253	1	Jerry	Wang	General	192.168.218.60	192.168.218.60-2	Background Verify Success	192.168.218.60-2-In	Only Card	Area Name	
2017-12-15 18:23:18	4481253	1	Jerry	Wang	General	192.168.218.60	192.168.218.60-2	Background Verify Success	192.168.218.60-2-In	Only Card	Area Name	
2017-12-15 18:23:12	4481253	1	Jerry	Wang	General	192.168.218.60	192.168.218.60-2	Background Verify Success	192.168.218.60-2-In	Only Card	Area Name	
2017-12-15 18:23:02	8155288	2	Lucky	Tan	Development Department	192.168.218.60	192.168.218.60-2	Background Verify Success	192.168.218.60-2-In	Only Card	Area Name	
2017-12-15 18:22:21	4481253	1	Jerry	Wang	General	192.168.218.60	192.168.218.60-2	Background Verify Success	192.168.218.60-2-In	Only Card	Area Name	
2017-12-15 18:20:24	9505930	9	Lilian	Mei	Development Department	192.168.218.60	192.168.218.60-2	Background Verify Success	192.168.218.60-2-In	Only Card	Area Name	

Created on: 2017-12-15 18:36:55
 Created from ZKBioSecurity software. All rights reserved.

Figure 3- 146 Report Export Page

Clear All Data: Click **Clear All Data** to pop up prompt, and then click **OK** to clear all events from today.

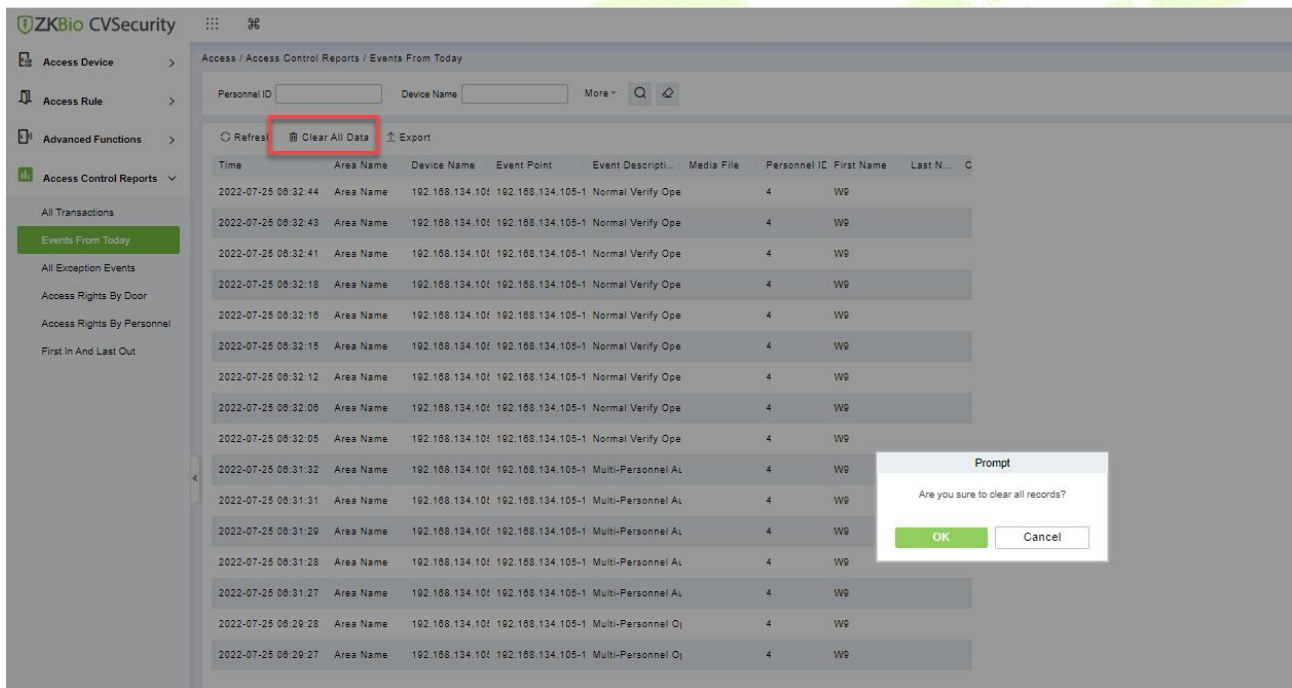

Figure 3- 147 Events Clear All Data

3.6.3 All Exception Events

Click **Access Control Reports > All Exception Events** to view exception events in specified condition. The options are same as those of **All Transactions**.

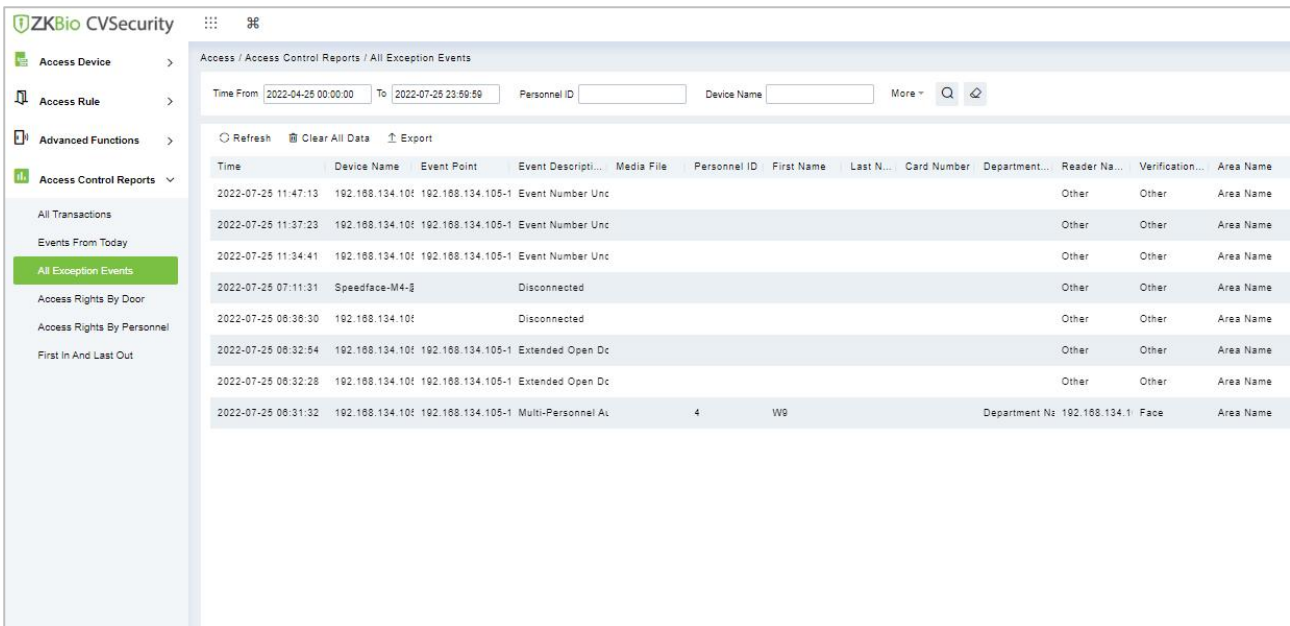

Figure 3- 148 All Exception events

Clear All Data: Click **Clear All Data** to pop up prompt, and then click **OK** to clear all exception events.

Export: You can export all exception events in Excel, PDF, CSV format.

ZKTECO												
All Exception Events												
Time: 2017-09-15 00 : 00 - 2017-12-15 23 : 59 : 59												
Time	Event Description	Event Point	Device Name	Card Number	Personnel ID	First Name	Last Name	Area Name	Department Name	Reader Name	Verification Mode	Remark
2017-12-15 17:43:03	Operation Interval too Short	192.168.218.80-1	192.168.218.80					Area Name		192.168.218.80-1-In	Other	
2017-12-15 17:42:41	Operation Interval too Short	192.168.218.80-1	192.168.218.80					Area Name		192.168.218.80-1-In	Other	
2017-12-15 17:35:27	Operation Interval too Short	192.168.218.80-1	192.168.218.80					Area Name		192.168.218.80-1-In	Other	
2017-12-15 16:35:17	Operation Interval too Short	192.168.218.80-1	192.168.218.80					Area Name		192.168.218.80-1-In	Other	
2017-12-15 16:35:06	Operation Interval too Short	192.168.218.80-1	192.168.218.80					Area Name		192.168.218.80-1-In	Other	
2017-12-15 16:34:00	Operation Interval too Short	192.168.218.80-1	192.168.218.80					Area Name		192.168.218.80-1-In	Other	
2017-12-15 16:33:52	Operation Interval too Short	192.168.218.80-1	192.168.218.80					Area Name		192.168.218.80-1-In	Other	
2017-12-15 16:33:43	Operation Interval too Short	192.168.218.80-1	192.168.218.80					Area Name		192.168.218.80-1-In	Other	
2017-12-15 16:33:35	Operation Interval too Short	192.168.218.80-2	192.168.218.80					Area Name		192.168.218.80-2-In	Other	
2017-12-15 16:33:14	Operation Interval too Short	192.168.218.80-1	192.168.218.80					Area Name		192.168.218.80-1-In	Other	
2017-12-15 16:08:54	Can not connect to server		192.168.218.80					Area Name		Other	Other	
2017-12-15 13:50:17	Disconnected		192.168.218.80					Area Name		Other	Other	
2017-12-15 11:53:45	Operation Interval too Short	192.168.218.80-1	192.168.218.80					Area Name		192.168.218.80-1-In	Other	
2017-12-15 11:41:04	Operation Interval too Short	192.168.218.80-1	192.168.218.80					Area Name		192.168.218.80-1-In	Other	
2017-12-15 11:19:45	Operation Interval too Short	192.168.218.80-1	192.168.218.80					Area Name		192.168.218.80-1-In	Other	
2017-12-15 11:19:37	Operation Interval too Short	192.168.218.80-1	192.168.218.80					Area Name		192.168.218.80-1-In	Other	
2017-12-15 11:05:50	Anti-Passback	192.168.218.80-1	192.168.218.80	9505930	800000005	Bill	Fang	Area Name	Visitor	192.168.218.80-1-In	Only Card	
2017-12-15 11:05:	Anti-Passback	192.168.218.80-1	192.168.218.80	13260079	800000004	Tom	Lee	Area Name	Visitor	192.168.218.80-1-In	Only Card	

Figure 3- 149 All Exception Events Export

3.6.4 Access Rights by Door

View related access levels by door. Click **Access Control Reports > Access Rights by Door**, the data list in the left side shows all doors in the system, select a door, the personnel having access levels to the door will be displayed on the right data list.

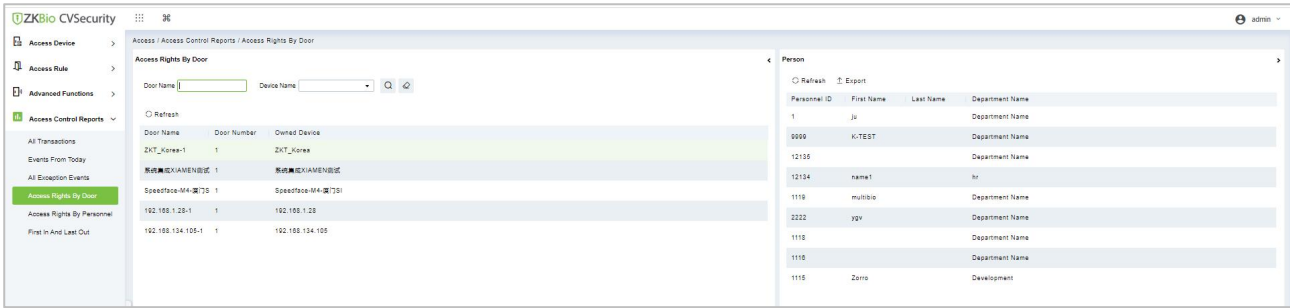

Figure 3- 150 Access Right by Door

You can export all the personnel having access levels to the door data in Excel, PDF, CSV format.

ZKTECO
192.168.218.60-1(1) Opening Personnel

Personnel ID	First Name	Last Name	Department
2940	Sherry	Yang	Hotel
1	Jerry	Wang	General
2	Lucky	Tan	Development Department
3	Leo	Hou	Financial Department
4	Berry	Cao	General
5	Necol	Ye	Marketing Department
6	Amber	Lin	Financial Department
7	Jacky	Xiang	General
8	Glori	Liu	Marketing Department
9	Lilian	Mei	Development Department

Figure 3- 151 Access Right by Door Export Page

3.6.5 Access Rights by Personnel

View related access levels by door or personnel.

Click **Access Control Reports > Access Rights by Personnel**, the data list in the left side shows all doors in the system, select personnel, the personnel having access levels to the door will display on the right data list.

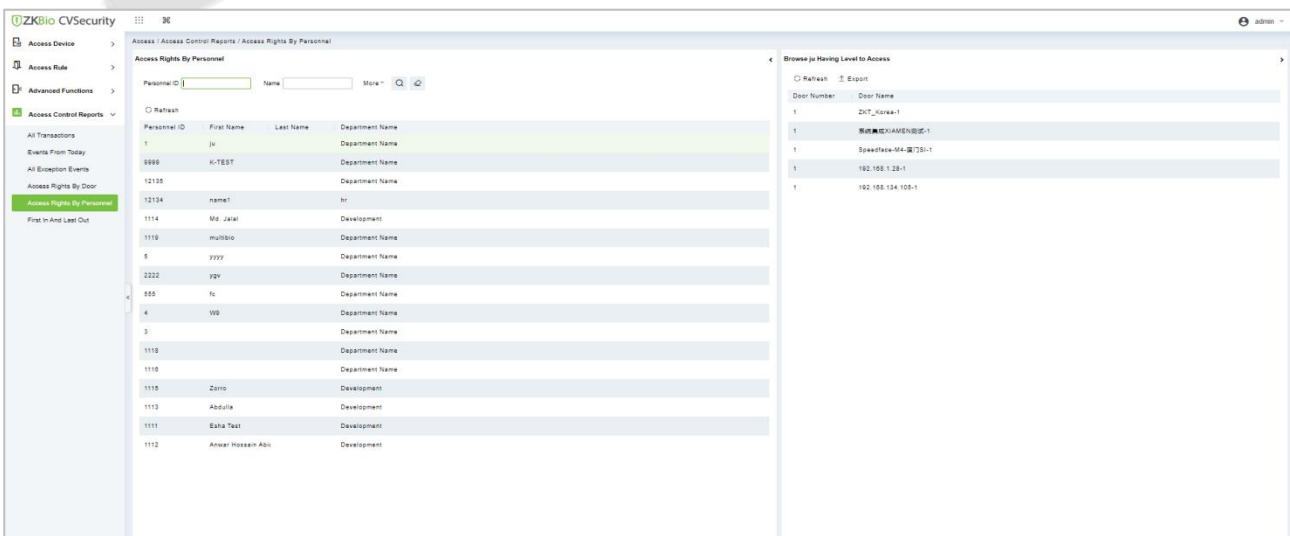

Figure 3- 152 Access Right by Personnel

You can export all the door information in Excel, PDF, CSV format.

ZKTECO	
6(Amber) Having Level to Access	
Door Number	Door Name
1	192.168.218.60-1
2	192.168.218.60-2
3	192.168.218.60-3
4	192.168.218.60-4

Figure 3- 153 Access Right by Personnel Export Page

3.6.6 First In and Last Out

Click **Access Control Reports > First in And Last Out** to view the First and the Last time interval.

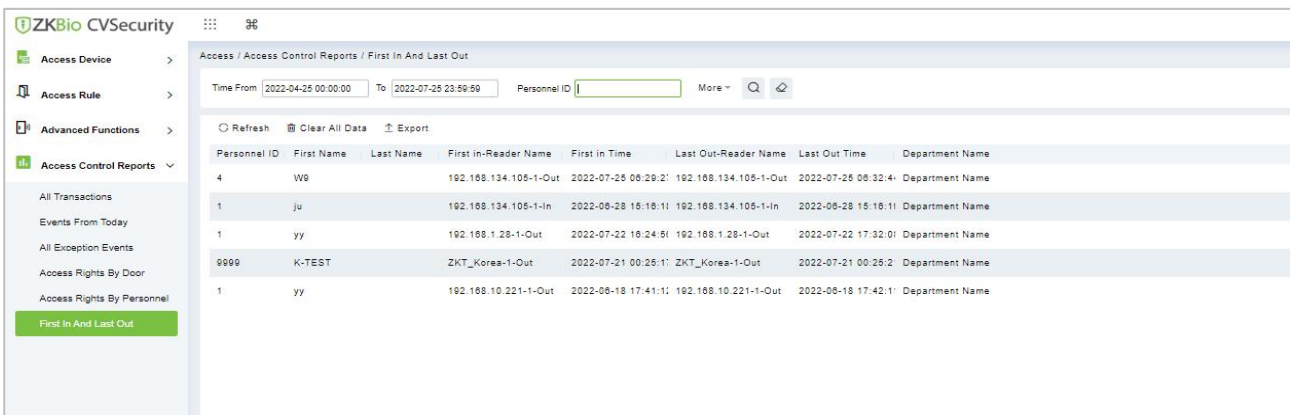

Figure 3- 154 Access Right by Door Export Page

3.6.6.1 Clear All Data

In the **Access > Advanced Control Reports > First in and Last Out**, click **Clear All Data** button under Operations. Click **OK** to clear all data.

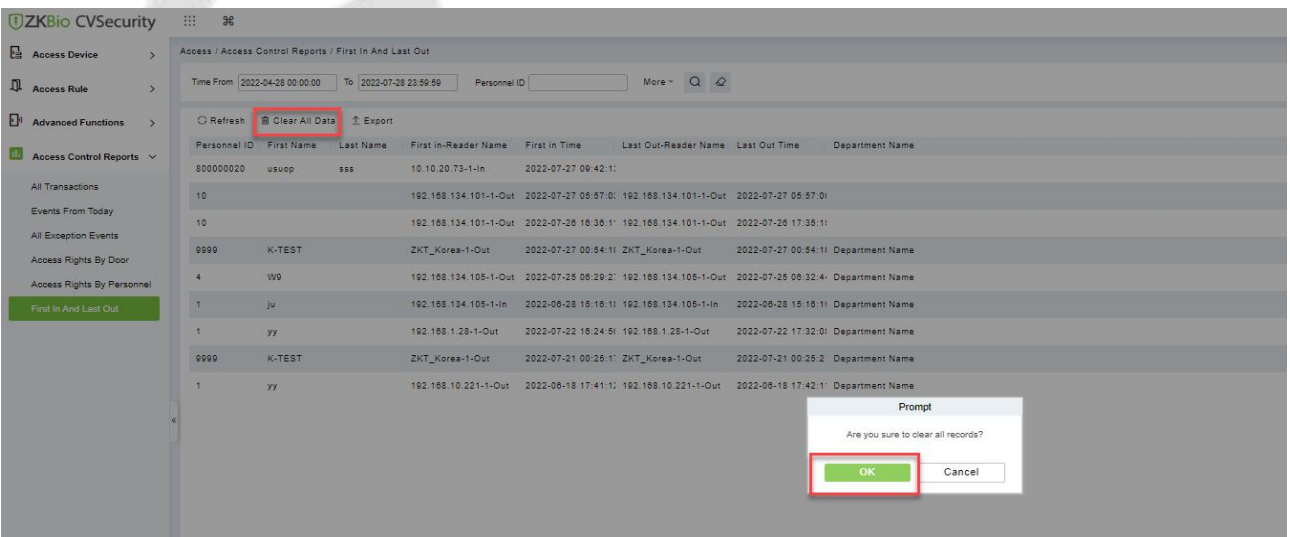

Figure 3- 155 Clear All Data

3.6.6.2 Export

On the All Records screen, click **Export**, enter the user password in the displayed security verification dialog box, and click **OK**. Select whether to encrypt the file and the file format to export, and click **OK**,

4 Video Management

4.1 Video view

Click **Video Management > Video View**.

In this module you can access the videos as **Video Preview** and **Video Playback**.

4.1.1 Video Preview

Click **Video Management > Video View > Video Preview**.

You can review recorded videos here

4.1.1.1 Live Preview

Description:

When applying video monitoring products, please strictly comply with the applicable laws and regulations for the application and maintenance of video monitoring, recording, snapping and other services. It is forbidden for enterprises or individuals to install monitoring device in office areas, monitor employees' behaviors, or use video monitoring device to snoop on other people's privacy for illegal purposes.

Single camera live preview:

Step 1: In the **Video Management** module, select **Video View > Video Preview**.

Step 2: In Full Devices, double-click the online camera to the live playback pane to open live preview.

Description:

During live preview, please do not overlap the windows, interfaces, or dialog boxes of other programs on the window that opens live, otherwise it may cause live screen or video playback to be unsmooth.

Live preview of group camera:

Step 1: In the **Video Management** module, select "**Device Management > Grouping Management**" to group the cameras.

Step 2: Click **Add** in the grouping list, enter the grouping name, and click "Confirm" to complete the addition of camera grouping.

Step 3: Select the newly created camera group and click "Add Camera" on the right side. Double-click the camera in the new interface that pops up, and click **OK** to add it to the grouping, as shown in Figure 4-1.

Step 4: In **Intelligent** module, select "**Video View > Video Preview**", and in "**Grouping Devices**", double-click the online camera to the live playback pane to open the live preview.

Description:

During live preview, please do not overlap the windows, interfaces, or dialog boxes of other programs on the window that opens live, otherwise it may cause live screen or video playback to be unsmooth.

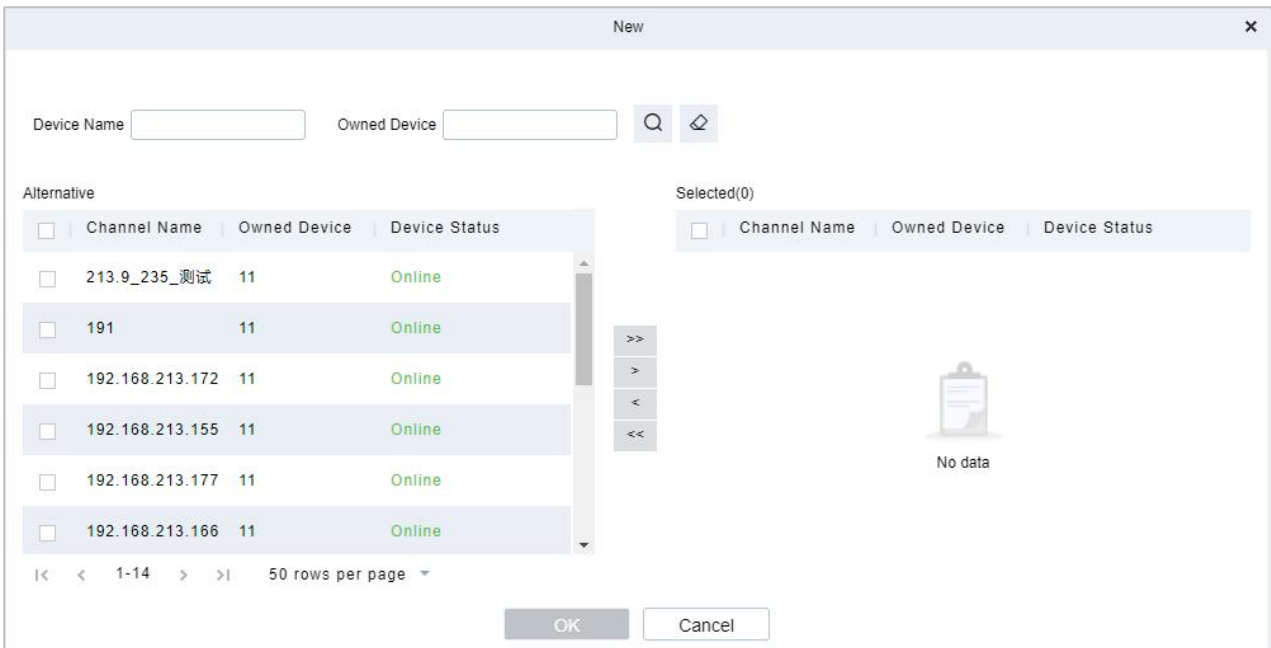

Figure 4- 1 Camera Grouping

4.1.1.2 Video Preview

Operation scenario:

Using the round patrol function, the user can switch the live pictures monitored by multiple cameras regularly. For example, there are multiple cameras in a scene, and the live situation of all cameras cannot be displayed on a live split screen interface. The administrator can automatically switch the cameras of a scene to monitor the live situation every 30 seconds by using the round patrol function and realize the live browsing of all cameras in batches and time periods.

Operating Steps:

Step 1: In the **Video Management** module, select Video View > Video Preview.

Step 2: Under the list of grouped devices or full devices, click "⏸" on the right to pop up the "Multiple Camera Operation Settings" page.

Step 3: Click "Round Tour" to open the round tour setting window and configure round tour information, as shown in Figure 4-2, and the parameter description is shown in Table 4-1.

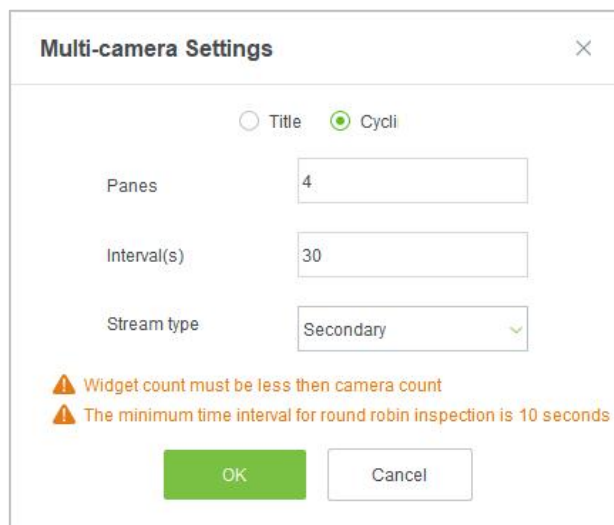



Figure 4- 2 New Rotation Training Group

Parameter	Description
Window number	The number of round-robin windows must be less than the number of round-robin cameras.
Time interval (seconds)	Set the camera rotation picture residence time under the selected main device.
Stream type	<ul style="list-style-type: none"> Main code stream: large code stream, high definition, and high bandwidth occupation. Auxiliary code stream: The code stream is small, the definition is low, and the bandwidth is small. <p>Description: When there is bandwidth limitation, it is recommended to select secondary code stream.</p>

Table 4- 1 Parameter Description of Round Patrol Configuration

Step 4: Click **OK** to start the round tour.

Step 5: End the round and click the toolbar  below to close all screens.

Fast Target Search:

Screenshot for quick target search during preview or replay:

When security guards view real-time surveillance or playback video and find a suspicious person in the screen, they can zoom in on that person and take a screenshot to support quick "target search" to jump to target search and person track mapping.

Step 1: Go to the **Video Management > Video Preview**, click  to snap a screenshot.

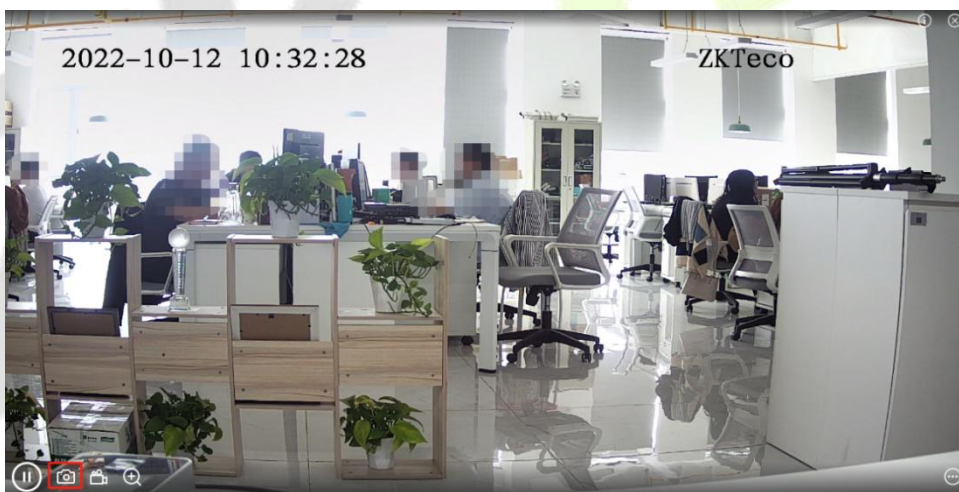

Figure 4- 3 Video Preview

Step 2: Then click **Target search**.

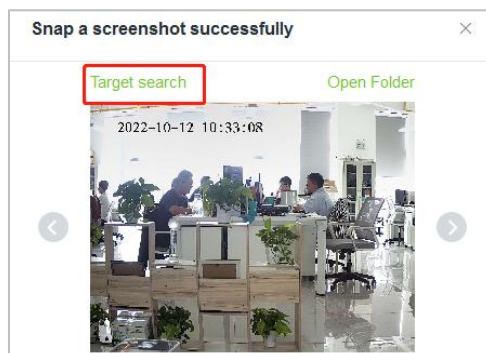

Figure 4- 4 Screenshot

Step 3: Next click Retrieval.

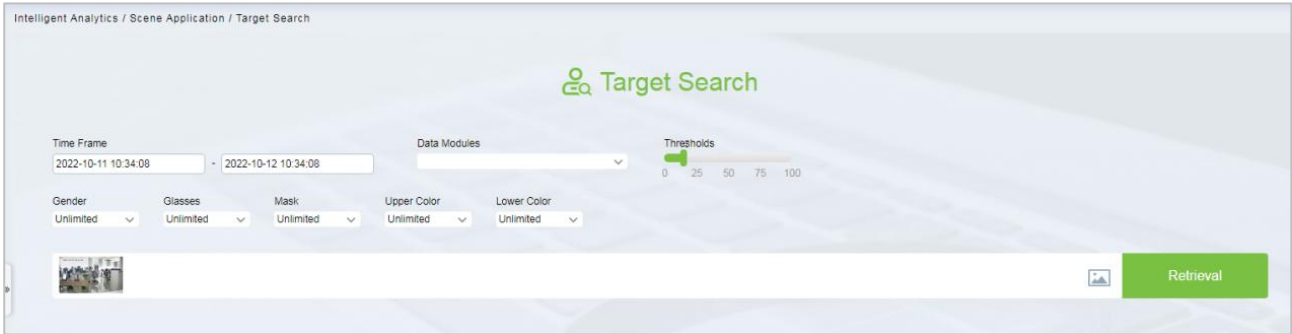

Figure 4- 5 Target search

Step 4: After the retrieval, the retrieval results appear.

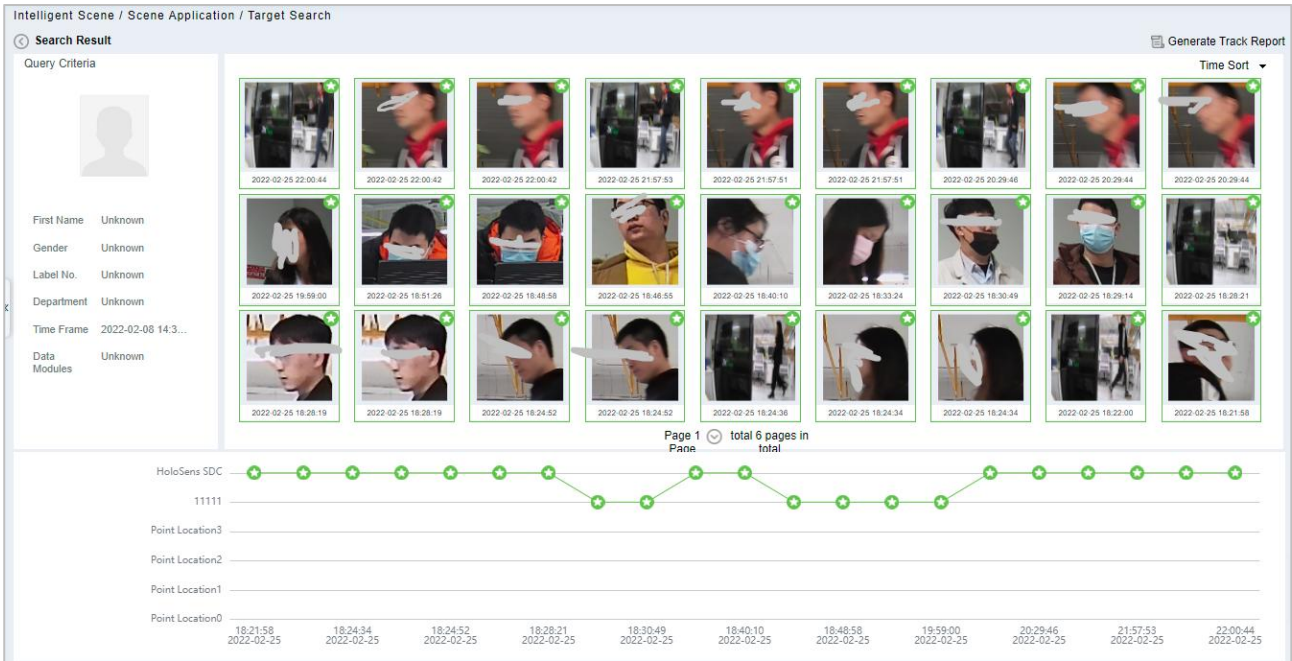

Figure 4- 6 Object Lookup Retrieval Results

Step 5: In the retrieval result, you can click Generate Trend Report in the upper right corner of the interface to export the trend report in PDF format, as shown in Figure 4-7 and Figure 4-8.

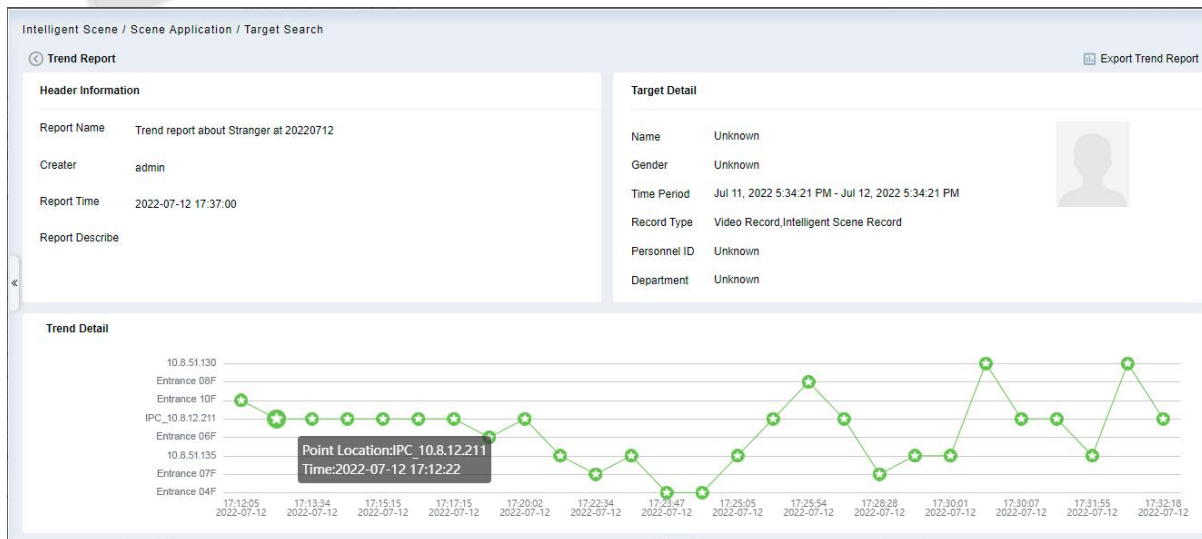

Figure 4- 7 Trend Report 1

Record Detail						
Event Time	Region	Event Source	Image	Event Name	Event Grade	
Jul 12, 2022 5:12:05 PM	Area Name	Entrance 10F		Stranger	Abnormal	
Jul 12, 2022 5:12:22 PM	Map	IPC_10.8.12.211		Face Detection Alarm	Normal	
Jul 12, 2022 5:13:34 PM	Map	IPC_10.8.12.211		Face Detection Alarm	Normal	
Jul 12, 2022 5:14:31 PM	Map	IPC_10.8.12.211		Face Detection Alarm	Normal	
Jul 12, 2022 5:15:15 PM	Map	IPC_10.8.12.211		Face Detection Alarm	Normal	
Jul 12, 2022 5:16:38 PM	Map	IPC_10.8.12.211		Face Detection Alarm	Normal	
Jul 12, 2022 5:17:15 PM	Map	IPC_10.8.12.211		Face Detection Alarm	Normal	

Figure 4- 8 Trend Report 2

4.1.2 Video Playback

Click **Video Management > Video View > Video Playback**.

4.2 Device Management

Step 1: Click **Video Management > Device Management**.

Step 2: Adding **Device, Camera and Group Management** are included.

4.2.1 Device (Add Device)

Scene Description:

This operation is used to instruct users how to connect NVR to the platform and cameras, so that the platform can manage the connected devices uniformly, such as viewing the live and video recordings of cameras.

4.2.1.1 Adding Devices (New)

Maximum supports 1024 video channels, support 64 channels prereview and 16 channels real-time playback simultaneously.

Operating Steps:

Step 1: Under the **Video Management** module, select **Device Management > Device**.

Step 2: Click **New** under the main device list to display the adding interface as shown in Figure 4-9, and the description of each parameter is shown in Table 4-2.

Figure 4- 9 New Master Device

Description:

There are 4 types you can select (AS1700/NVR800/ZKNVR/TD NVR3000) , If the purchased device is AS1700, select "AS1700" for the type.

Parameters/Buttons	Description
Type	Select the device type.
Name	Customize the device name.
Address	Configure the device address. The format is: xxx.xxx.xxx.xxx, for example: 192.168.6.5.
Port	Configure the device port.
Username and Password	The NVR'S user name and password. Note: For ZKNVR, the default account is (admin,12345678) For AS1700, you should to login the web page to add a new account.

Table 4- 2 Adding Device Parameters or Function Description

Step 3: Click **OK**.

4.2.1.2 Delete

Click **Video Management > Device Management > Device**, then select **Delete**.

4.2.1.3 Search

Click **Video Management > Device Management > Device**, then select **Search**.

Note: Search is not supported for AS1700/TD NVR3000.

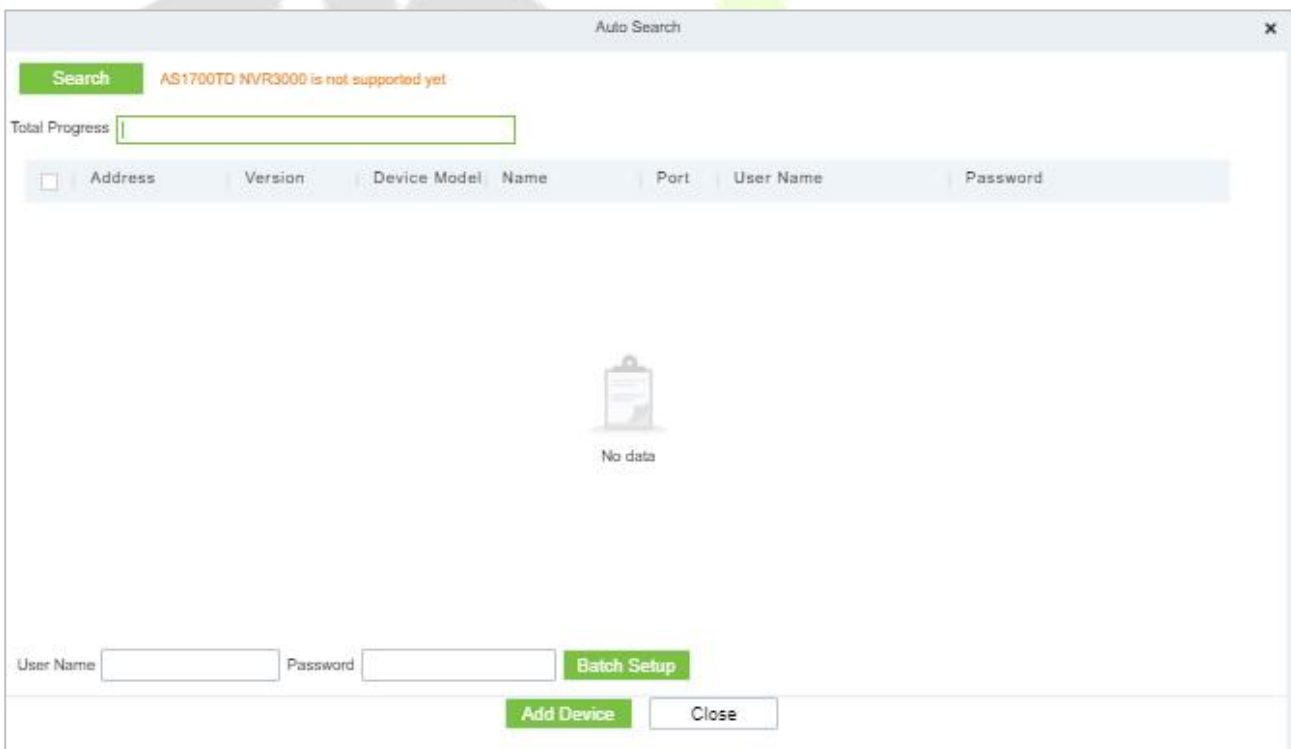

Figure 4- 10 Auto Search

4.2.1.4 Sync Camera

Click **Video Management > Device Management > Device**, then select **Sync Camera**.

4.2.1.5 More

For AS1700: It Includes options like Edit, Target Maintenance, Maintenance management, View Information, Personnel Frequency Analysis, Face Fortify, Face list library, Vehicle Fortify, Vehicle List Library, Alarm Management, Task Manage, Storage Management, Third-Party Algorithm Configuration, Email Configuration, Subscription, Unsubscribe and Sync Time.

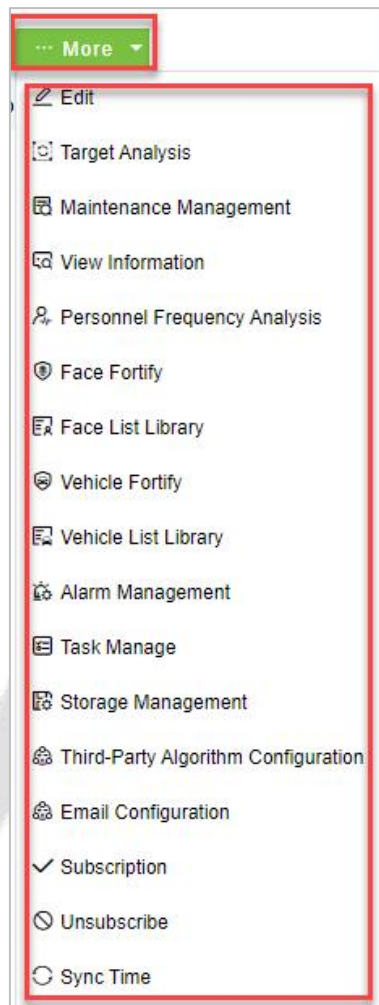

Figure 4- 11 AS1700 More (Device)

For ZKNVR: It include options like Edit, Maintenance Management, Email Configuration, Subscription, Unsubscribe, and Sync Time.

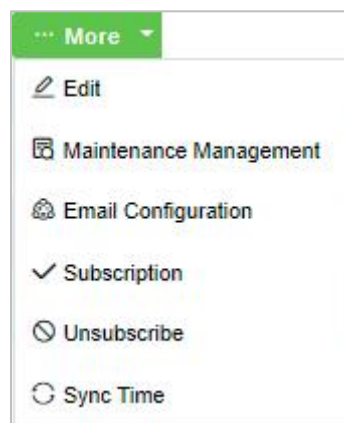

Figure 4- 12 ZKNVR More (Device)

4.2.1.6 Group Device

Click **Video Management > Device Management > Device**, then select **Grouping Device**.

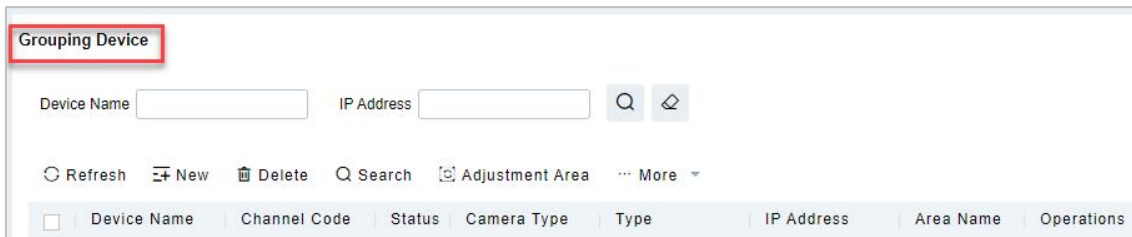

Figure 4- 13 Group Device

4.2.2 Camera

Click **Intelligent Video > Device Management > Camera**.



Figure 4- 14 Camera

4.2.2.1 Search Method Add (Recommended)

For AS1700: cameras that can be accessed to AS1700 through HWSDK and ONVIF protocol, this access method is recommended, which can complete the fast access of cameras.

Operating Steps:

Step 1: In the **Video Management** module, select **Device Management > Device**.

Step 2: Select AS1700 to add cameras under the main device list, and then click **Search** under the list of cameras on the right.

Step 3: Search the camera by IP address.

In the search interface, select the protocol type and the start and end IP address of the input device.

Description:

The protocol type supports the selection of ONVIF and HWSDK protocols

It is recommended to set the starting IP address and ending IP address accurately. If there are fewer cameras in a large IP address range, the search time will be longer.

If the start IP address and the end IP address are set, the system searches the cameras in unicast form, and the system can search the cameras in the IP address segment. If multiple IP address segments are set, the system can search for cameras in multiple VLANs.

If the starting IP address and ending IP address are not set, the system searches cameras in the form of broadcast. At this time, the system can only search cameras in the same network segment as the IP address of this server but can't search cameras in other IP address segments or other VLAN. Therefore, it is recommended to set IP address segment to search cameras or add cameras in batches.

Click **Start Search** to start searching for online cameras.

Step 4: Account verification.

For the searched camera, select a camera in the camera list, and then verify the account, as shown in Figure 4-15. Refer to Table 4-3 for parameter description.

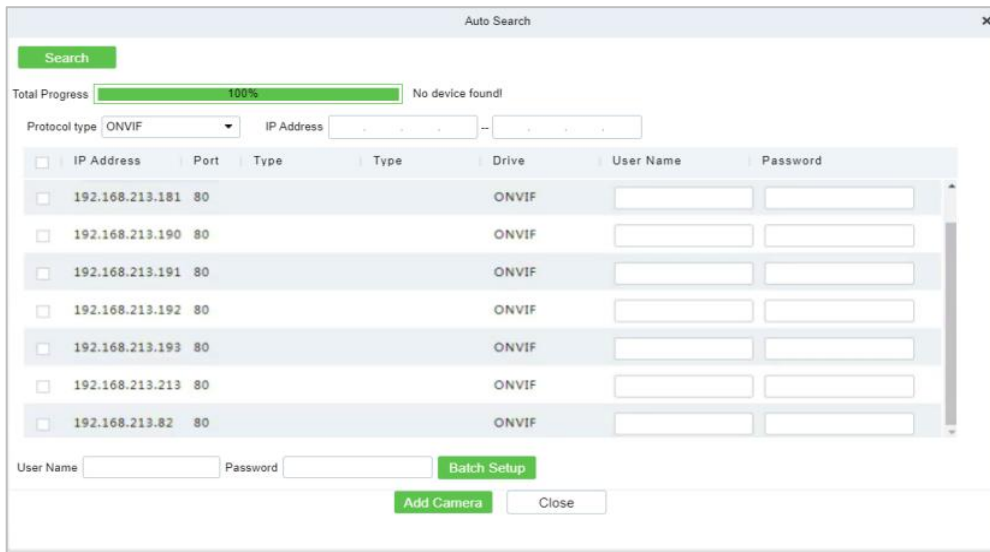

Figure 4- 15 Account Verification

Parameter	Parameter description
Port	When suggestions are added through HWSKD protocol, the default port is 6061. When recommendations are added through the ONVIF protocol, the default port is 80.
Account/ Password	Registered username and password of the camera. If all the cameras to be added have the same registered username and password, you can also use the username and password at the bottom of the search list for batch verification. Description: For Intelligent cameras, when accessing through different protocol types, the location of the registration password in the camera Web interface is different: HWSKD Protocol: The registered password is "sDK Password" in " Advanced Configuration > Network > Platform Docking Parameters > Password Management ". ONVIF protocol: The registered password is "ONVIF password" in " Advanced Configuration > Network > Platform Docking Parameters > Password Management ". GB/T 28181 Protocol: The registered password is "Password" in " Advanced Configuration > Network > Platform Docking Parameters > Second Protocol Parameters ".

Table 4- 3 Parameter Description

Description:

About port numbers:

If the camera is added through ONVIF protocol, the port does not need to be modified; If the camera is added through HWSKD protocol, it is recommended to configure port 6061. After the camera is connected, the message transmission will be encrypted, which improves the security of information transmission.

About camera registration username and registration password:

Usually, the registered username and password of the camera are the username and password of logging in to the Web interface. For some cameras, there may be inconsistency between the

two. Please use the registered username and password of the actual camera as the value of this parameter.

If the camera default password has been modified, please do not click "Verify" continuously. Clicking 5 times or more continuously will cause the platform to lock. After the platform is locked, you need to wait for the platform to be unlocked or restart the camera to add it again.

Step 5: Select the camera to add and click **Add Camera**.

The return result interface pops up to display the result of camera access.

Step 6: Close the pop-up window and complete the search and addition of cameras.

Step 7: Subsequent configurations are shown in Table 4-5.

Scene	Configuration location	Configure
Add Cameras Through ONVIF Protocol	Camera Web Interface	Configure docking parameters, see Camera Web Interface Docking Configuration-ONVIF for details.
Camera Join Grouping	Device Management > Group Management	Create groups and add cameras to facilitate the grouping management of cameras.
Adjustment Area	Device Management > Master Device > Camera Device	Under the "Camera device" list, you can check one or more cameras and click the "Adjust Area" button to adjust the area where the cameras belong.

Table 4- 4 Subsequent Configuration Instructions

4.2.2.2 Camera to ZKNVR Device

Search Method Added (Recommended):

This section describes the configuration steps for automatically adding cameras in batches in the ZKBio CVSecurity. For cameras th Step 4: In Intelligent module, select "**Video View > Video Preview**", and in "**Grouping Devices**", double-click the online camera to the live playback pane to open the live preview.

Description:

During live preview, please do not overlap the windows, interfaces, or dialog boxes of other programs on the window that opens live, otherwise it may cause live screen or video playback to be unsmooth.at can be connected to ZK NVR through ZKTeco-P, Rtsp, ZKTeco and ONVIF protocols, this access method is recommended to complete the quick access of cameras.

Steps:

Step 1: In the **Video Management** module, select "**Device Management > Main Device**".

Step 2: Select the ZKNVR whose camera is to be added under the main device list, and then click **Search** under the camera list on the right.

Step 3: Search for cameras by IP address.

In the search interface, select the protocol type, that is, the protocol type ZKTeco-P, Rtsp, ZKTeco or ONVIF (recommended to use ZKTeco) connected to the camera.

Instruction:

1. Protocol type supports the selection of zkteco-P, Rtsp, zkteco and ONVIF protocols. (recommended to use zkteco).
2. Using zkteco protocol access, all functions can be used normally.
3. The ONVIF protocol is used to access, and the IPC parameter configuration except "camera" and "image parameter" does not take effect.

- Using zkteco-P, Rtsp, protocol access, PTZ control cannot be used, and IPC parameter configuration does not take effect.

Click **Start Search** to start searching for online cameras.

Step 4: Account verification.

For the searched cameras, directly check the cameras in the camera list, and then perform account verification (the account number and password are the camera's registered user name and password), as shown in Figure 4-16, and parameter descriptions are shown in Table 4-5.

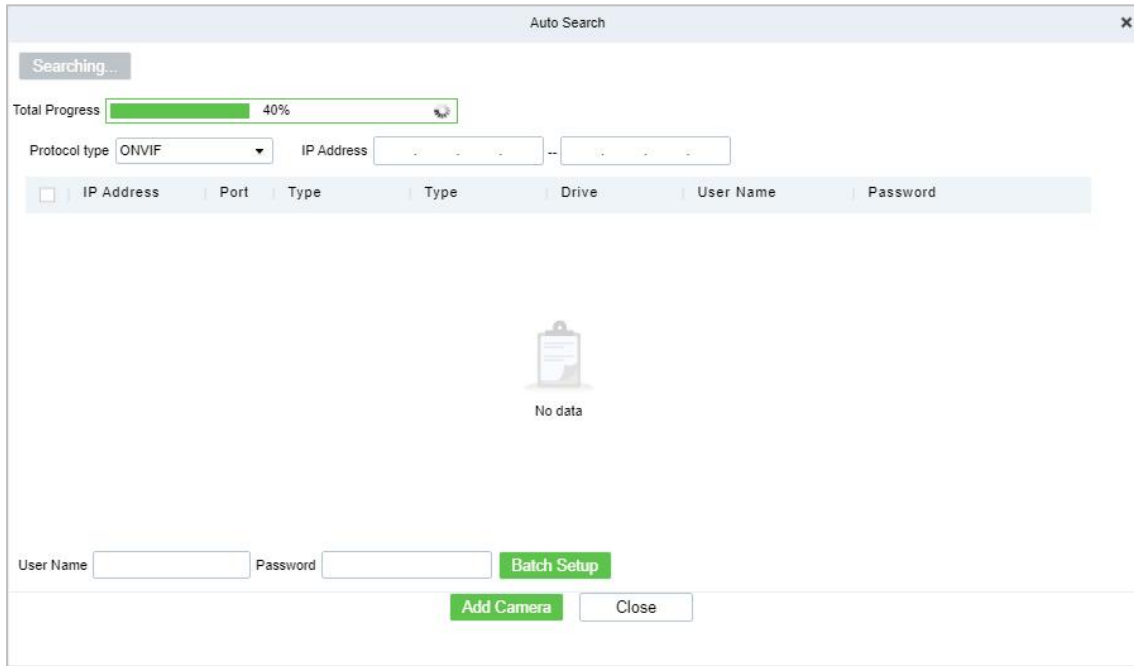

Figure 4- 16 search methods added

Parameter	Parameter Description
Port	Through zkteco-p, rtsp, zkteco, onvif protocols, the default port is 80.
Account Password	The registered username and password of the camera. If all cameras to be added have the same registered username and the same registered password, you can also use the username and password at the bottom of the search list for batch verification.

Table 4- 5 Parameter Description

Step 5: Close the pop-up window to complete the search and addition of cameras.

Step 6: The subsequent configuration is shown in Table 4-6.

Scenes	Configuration Location	Configure
Camera Grouping	"Device Management > Group Management"	On the Group Management interface, click Add to create a group, click Add Camera on the right, and check the camera to complete the camera grouping.
Adjust Area	"Device Management > Main Device > Camera Device" list	Under the Camera Device tab, you can select single or multiple cameras, and then click the Adjustment Area button to adjust the area to which the cameras belong.

Table 4- 6 Subsequent configuration instructions

4.2.2.3 Manual Add

This paper introduces the configuration Steps of adding cameras in platform by "adding".

Operation Steps:

For AS1700: In the **Video Management** module, select **Device Management > Master Device**.

Step 1: Select the AS1700 to which a camera is to be added in the main device list and Click **Add** under the camera list on the right. The add camera page is displayed.

Step 2: Set the corresponding content according to the new requirements, as shown in Figure 4-17. Please refer to Table 4-7 for parameter filling instructions.

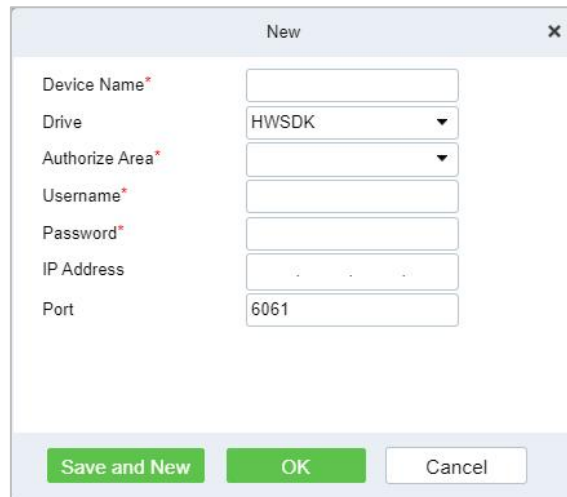

Figure 4- 17 New Camera

Parameter	Description
Device Name	The name of the device displayed on the platform. It is recommended to enter the installation location or monitoring area of the device.
Drive	Protocol type of camera access. Description: <ul style="list-style-type: none"> When Dahua camera accesses AS1700, it needs DHSDK protocol. When accessing the camera, please ensure that the corresponding plug-in has been installed, and you need to wait for 5 minutes before accessing the device, otherwise the device cannot be accessed normally. When T3B15-IS or BioX Series cameras are accessed to AS1700, it is recommended to access them by HWSDK protocol: if the cameras are accessed to AS1700 by ONVIF protocol, the front-end video occlusion, motion detection and behavior analysis functions cannot be enabled, and can only be used when accessing by HWSDK protocol.
Authorized Area	Select the area where the camera belongs. If it is not specified, the current camera belongs to the default area. The area is the area that has been configured in System Administration Module > System Administration > Regional Settings. Users with permissions on this zone can view and operate devices under the current zone.
Interconnect Coding	This parameter can be configured only when the Add Devices the system through T28181 protocol. Consistent with the "Device ID" of T3B15-IS or BioX Series Camera/Consistent with the 'sIP User Authentication ID" of Haikang Camera, in which 11 ~ 13 bits are required to be 132.

Parameter	Description
	<p>Description: Interconnection coding is required to be a 20-bit integer, and when it is less than 20 bits, it needs to be supplemented with 0.</p>
Enable RTSP	<p>This parameter can be configured only when the Add Devices the system through DHSDK protocol. After RTSP is enabled, when users browse the live picture through the platform, the live picture is directly fetched from the camera without MU processing and forwarding, which reduces the pressure of the system. Enable RTSP fetching function and require the platform and front-end device to configure the same port (default port 554).</p>
Username/ Password	<p>The registered username and password used by the camera when registering with the device. For Intelligent cameras, when accessing through different protocol types, the location of the registration password in the camera Web interface is different:</p> <ul style="list-style-type: none"> • HWSDK Protocol: The registered password is 'sDK Password' in "Advanced Configuration > Network > Platform Docking Parameters > Password Management". • ONVIF protocol: The registered password is "ONVIF password" in "Advanced Configuration > Network > Platform Docking Parameters > Password Management". • GB/T 28181 Protocol: The registered password is "Password" in "Advanced Configuration > Network > Platform Docking Parameters > Second Protocol Parameters".
IP Address	Represents the IP address of the device.
Port	<p>Represents the access port of the device. It is recommended to keep the default value of the port. If the camera side modifies the port number, please fill it in according to the actual situation.</p> <p>Instructions:</p> <ul style="list-style-type: none"> • When the camera is registered using HWSDK protocol, it is recommended to configure port 6061. After the camera is connected, the message transmission will be encrypted, which improves the security of information transmission. • After the camera is successfully accessed, if the port number is modified, the live camera will be disconnected and reconnected for about 1-5 seconds, which is related to the actual network situation.

Table 4- 7 Parameter Description for Manual Single Access

Step 3: Click **OK** to complete the addition of camera device.

Step 4: See Table 4-8 for subsequent configuration.

In the following cases, it is necessary to complete the subsequent configuration on the camera side before the camera can be used normally.

Scene	Configuration location	Configure
Adding Cameras Through T28181 Protocol	Camera Web interface	To configure docking parameters, please refer to 4.1. 2.3. 1 Camera Web Interface Docking Configuration-GB/T28181 for details
Adding Camera Via ONVIF Protocol	Camera Web interface	Configure docking parameters, see 4.1. 2.3. 2 Camera Web Interface Docking Settings-ONIVIF for details.
Camera Join Grouping	Device Management > Group	Create groups and add cameras to facilitate

Scene	Configuration location	Configure
	Management	the grouping management of cameras.
Adjustment Area	"Device Management > Master Device > Camera Device"	Under the "Camera device" list, you can check one or more cameras and click the "Adjust Area" button to adjust the area where the cameras belong.

Table 4- 8 Subsequent Configuration Instructions

4.2.2.4 Camera Connect to AS1700

● Camera Web Interface Configuration-Gb/T28181

When cameras dock the platform through GB/T28181 protocol, the corresponding docking parameters need to be configured in the camera Web interface.

Precondition:

1. GB/T28181 protocol uses MD5 digest authentication, MD5 is a weak algorithm, there are security risks. And the signaling stream and media stream are not encrypted, please use this protocol in trusted network, otherwise there may be security risks.
2. When using GB/T28181 protocol to interface with AS1700, you need to obtain the parameters when adding cameras on the platform side, such as device ID.

Set System Time:

By docking with the platform through this protocol, it is necessary to make sure that the system time of the camera is calibrated by NTP.

Step 1: Enter the IP address of the camera in the browser address bar and click **Enter**.

Step 2: Enter the camera's "username" and "password" and click **Login**.

Step 3: In the **Camera Web** interface, select the "**Advanced Configuration > System Configuration > Time Setting**" tab to enter the "Time Setting" configuration interface.

Step 4: In the **Time Setting** interface, set NTP timing and click **Save**, as shown in Figure 4-18. Please refer to Table 4-9 for parameter description.

The screenshot shows a configuration window for NTP timing. It includes a dropdown for 'Time zone' set to '(UTC+08:00) Beijing, Hong Kong', radio buttons for 'Calibration mode' with 'NTP' selected, a text input for 'NTP server' containing 'ntp.ntsc.ac.cn', a 'Detect NTP server' button, a text input for 'Synchronization interval (min)' set to '60', and a 'Device time' display showing '2021-12-20 17:36:24'. A 'Save' button is located at the bottom left.

Figure 4- 18 Configuring NTP Timing

Parameter	Description
Time zone	Select the time zone where the NTP server is located.
Timing method	Select NTP Timing.
NTP Server	IP address of AS1700.
Synchronization time interval	The interval at which time synchronization takes place.

Table 4- 9 Explanation of NTP Timing Parameters

● **Configure Gb/T28181 Protocol Parameters**

Steps:

Step 1: Log in to the camera through the Web and select “**Advanced Configuration > Network > Platform Docking Parameters**”. The system displays the interface of "Platform Docking Parameters".

Step 2: Select “**Second Protocol Parameters > T28181**” and check "GB/T28181" to enable GB/T28181 protocol.

Step 3: Configure the GB/T28181 parameters, as shown in Figure 4-19, and the parameter description is shown in Table 4-10.

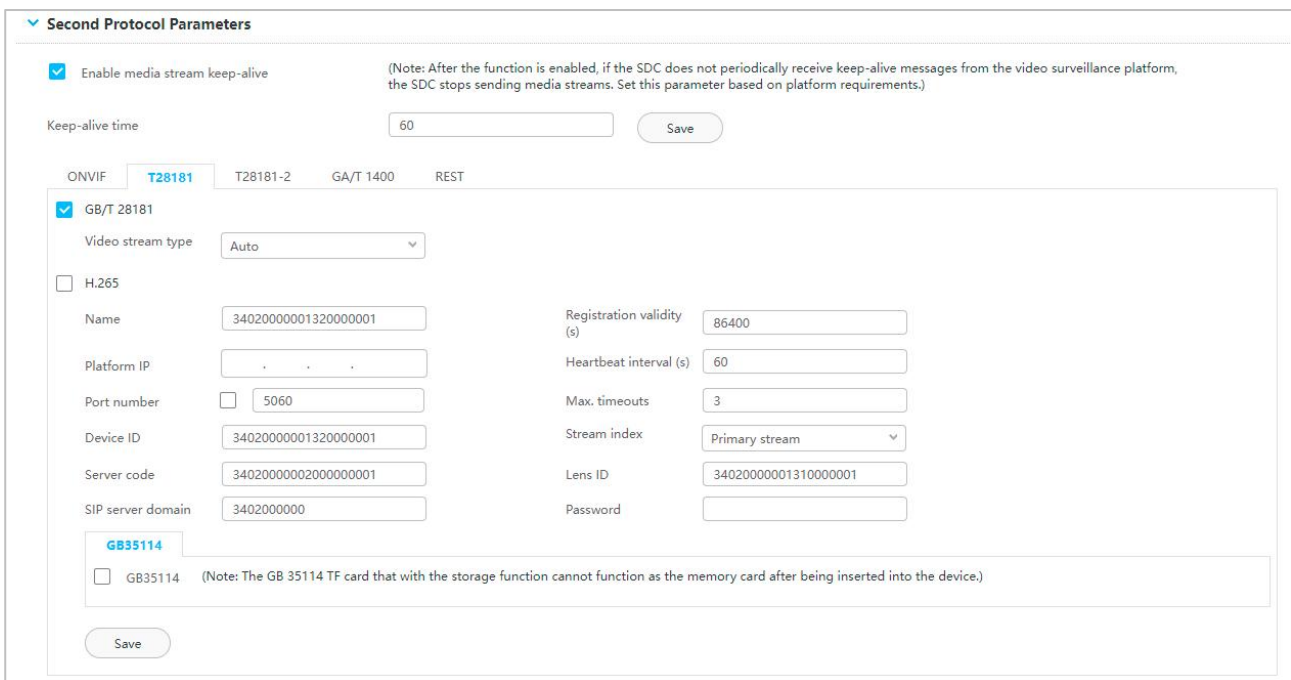

Figure 4- 19 Gb/T28181 Parameter Interface

Parameter	How to Configure
Media Streams Keep Alive Switch	Enable the "Media Stream Keep Alive Switch" and tick it to indicate that it is enabled. After the media stream keeping alive function is turned on, if the camera does not receive the media keeping alive packet sent by AS1700 within a certain period of time, the camera stops sending the media stream. When the platform supports keep-alive function, it is recommended to "enable".
Keep-alive Times	The number of keep-alive connections between the camera and AS1700 media stream is an integer in the range of 2 to 24, and the single keep-alive time is 5s. For example, when the number of keep-alive times is 2, the media stream keep-alive time is 2*5s, that is, 10s. Even if the camera does not receive the media keep-alive packet within 10s, it will not stop sending the media stream, and if it does not receive the keep-alive packet for more than 10s, it will stop sending the media stream.
Name	Customize the login name used when registering with AS1700 system.
Platform IP	Enter the IP address of the AS1700 system.
Port Number	Platform listens on GB/T28181 protocol port number. Port number 5080 is used when docking H" platform. If the server and camera are on different networks and NAT exists, it is configured as the mapped port of 5080.
Device ID	Custom setting device ID, requiring 132 bits 11 to 13 and 0 bits last, and the ID of each device must be unique.

Parameter	How to Configure
Server Code	GB/T28181 server code. Custom input 20 digits, which require the 11th to 13th digits to be 200. For cameras connected to the same AS1700 system, the server codes must be consistent.
@	Domain name, custom input 10 digits.
Password	Customize the registration password of the camera in the platform. In order to improve security, it is recommended that the password should be 8 to 20 characters in length and contain at least two letters, numbers and special characters.
Lens ID	Custom setting device lens ID number, required to be 20 digits and the 11 to 13 digits must be 131, otherwise AS1700 system cannot view the live.
Alarm Input ID	ID of the device alarm input. The platform assigns an alarm input ID to the camera according to the device ID.
Audio Output ID	ID of the device audio output. The platform assigns an audio output ID to the camera according to the device ID.

Table 4- 10 Parameter Explanation

Step 4: Click **Save**.

● Camera Web Interface Configuration-ONVIF

When the camera docks AS1700 through ONVIF protocol, the corresponding docking parameters should be configured in the camera Web interface.

Precondition:

ONVIF retains MD5 digest authentication. MD5 is a weak algorithm with security risks, and the media stream is not encrypted. Please use this protocol in a trusted network, otherwise there may be security risks.

- If the ONVIF protocol needs to use the H.265 encoding protocol, the ONVIF version of the camera and AS1700 need to support the H.265 encoding protocol. Intelligent cameras require V200R003C10 and later. Please contact the provider for AS1700 to confirm support. Otherwise, please modify the coding protocol of video stream (including main code stream and sub-code stream) to H.264 first, and then configure the parameters in the device. For specific operation, please log in to the camera Web interface, select "Advanced Configuration > Audio View > Video Stream Parameters", and set "Encoding Protocol" to "H.264".
- The ONVIF protocol defaults to the HTTP/HTTPS transport protocol type.
- ONVIF protocol only supports G711U audio coding format, and other audio coding formats will cause the functions such as accompanying voice, voice intercom and voice broadcast to be unavailable.
- When using ONVIF protocol to interface with AS1700, the default port number is "80".

Operating Steps:

Step 1: Log in to the camera's Web interface (https://IP address).

Step 2: Select **Advanced Configuration > Network > Platform Docking Parameters**. The system displays the interface of **Platform Docking Parameters**.

Step 3: Select **Second Protocol Parameters > ONVIF** to enter ONVIF Protocol Parameters Configuration Interface. Configure the ONVIF parameters, as shown in Figure 4-20, and the parameter description is shown in Table 4-11.

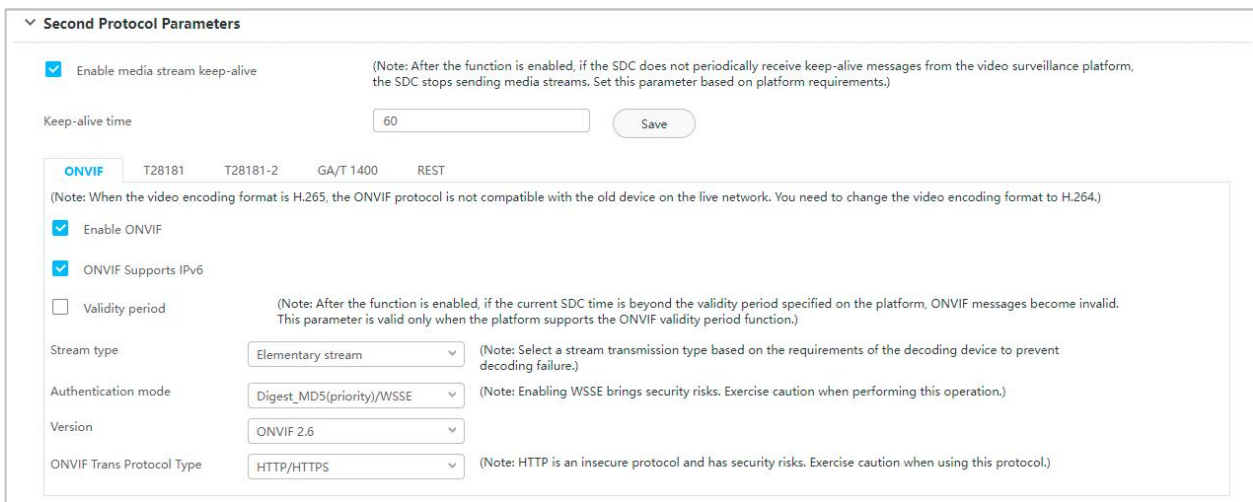

Figure 4- 20 ONVIF Parameter Interface

Parameter	How to configure
Media Streams Keep Alive Switch	Enable the "Media Stream Keep Alive Switch" and tick it to indicate that it is enabled. After the media stream keeping alive function is turned on, if the SDC does not receive the media keeping alive packet sent by AS1700 within a certain period of time, the SDC stops sending the media stream. When the platform supports keep-alive function, it is recommended to "enable".
Lifetime	Time (s) for SDC and AS1700 media streams to keep alive, an integer in the range of 10 to 120. For example, when the keep-alive time is set to 60s, the SDC will not stop sending the media stream even if it does not receive the media keep-alive packet within 60s and will stop sending the media stream if it does not receive the keep-alive packet after 60s.
Enable ONVIF	Enable ONVIF protocol, ticked to indicate enabled.
ONVIF message validity period	Enable "ONVIF message validity period" and tick it to indicate that it is enabled. After the ONVIF message expiration date function is turned on, if the expiration date set by the platform is exceeded, the ONVIF message will be invalid. Description: This function is only enabled when the platform supports ONVIF message validity function, otherwise it cannot be successfully docked with AS1700, and it is only recommended to enable it when there is a security risk, and it is turned off by default.
Onvif Metadata Flow Switch	If "ONVIF Metadata Stream Switch" is checked, the metadata stream of the camera can be obtained, otherwise, only video stream and audio stream can be obtained. "ONVIF Metadata Flow Switch" is checked by default.
ONVIF Stream Transmission Type	Please select the desired streaming type in the drop-down box after Streaming Type, and the default is Basic Stream. <ul style="list-style-type: none"> Elementary Stream: ES (Elementary Stream) packaging method is adopted. Program Stream: PS (Program Stream) packaging mode is adopted. Description: <ul style="list-style-type: none"> Please select the stream transmission type according to the requirements of decoding device, so as not to be unable to decode. The configuration of the ONVIF media stream is only valid when the SDC interfaces with the platform through the ONVIF protocol.
ONVIF Authentication	Please select the required authentication method in the drop-down box after Authentication Method.

Parameter	How to configure
Mode	<ul style="list-style-type: none"> • Digest_MD5: Digest authentication for MD5 encryption. • Digest_SHA256: Digest authentication for SHA256 encryption. • Digest_MD5/Digest_SHA256: Both Digest_MD5 and Digest_SHA256 authentication methods are supported. • Digest_MD5 (priority)/WSSE: Both Digest_MD5 and WSSE authentication modes are supported, but Digest_MD5 authentication mode is preferred. • WSSE (Web Service Security): "WSSE" authentication method. • None: Indicates no authentication. <p>Description:</p> <ul style="list-style-type: none"> • There is a security risk using ONVIF WSSE authentication. <ul style="list-style-type: none"> – It is recommended to enable Digest_MD5 (priority)/WSSE authentication when some platforms accessed by the camera do not support HTTP digest authentication and only support ONVIF WSSE authentication. – It is recommended that WSSE authentication be enabled when HTTP digest authentication is not supported on all platforms on which the camera is accessed and only ONVIF WSSE authentication is supported. – It is recommended that WSSE authentication be enabled when some platforms fail to properly handle Digest messages. • There are security risks in using None authentication, so it is only recommended to enable it when the platform does not support authentication. When using None authentication mode, the ONVIF protocol is used to drain and the RTSP protocol is used to request live, and authentication will not be carried out.
ONVIF Version Information	The ONVIF version supported by the camera needs to be consistent with the ONVIF version supported by the platform.
ONVIF Transport Protocol Type	<p>ONVIF transport uses protocol types:</p> <ul style="list-style-type: none"> • HTTP/HTTPS: It can be transmitted over HTTP or HTTPS protocols, respectively. • HTTP: Transport using the HTTP protocol. • HTTPS: Transport using the HTTPS protocol. <p>Description: HTTP protocol is not safe protocol, there are risks, please use cautiously.</p>
Modify The ONVIF Password	<p>Method 1:</p> <ol style="list-style-type: none"> 1. Select the "Password Management" tab under 'second Protocol Parameters'. 2. Select "ONVIF Password" and enter "Web User Password", "New Password" and "Confirm Password" for the ONVIF protocol. 3. Click Save. <p>Method 2:</p> <ol style="list-style-type: none"> 1. Select Advanced Configuration > System Configuration > Password Management. 2. Select Protocol Password. 3. Select "ONVIF Password" and enter "Web User Password", "New Password" and "Confirm Password" for the ONVIF protocol. 4. Click Save. <p>Description:</p> <ul style="list-style-type: none"> • To ensure the security of data information, please change the ONVIF password in time. <p>When using ONVIF protocol to dock with AS1700, the username and password used by AS1700 must be consistent with this password, otherwise the docking with AS1700 cannot be successful, and the platform will be locked for 5 minutes after 20 consecutive authentication failures. After the password is modified, please record and save it in time.</p>

Parameter	How to configure
	<ul style="list-style-type: none"> The default username is "admin," and the Web user password is the same as the user currently logged on to the Web. In order to improve security, it is recommended that the password length be 8 to 20 characters, and contain at least two uppercase letters, lowercase letters, numbers and special characters.

Table 4- 11 Explanation of ONVIF Parameters

4.2.2.5 Result

In the video device management interface, the added device status is displayed as "online", and the live broadcast can be seen at the same time, which means the addition is successful.

Operating Steps:

Step 1: Check to see if the device is online.

In the **Video Management** module, select Device Management > Master Device.

Select the master device list AS1700 devices, and in the camera device list on the right, check whether the added device status is "online" under the "device status" parameter.

Description:

If the camera is offline due to some reasons after the camera is successfully added for the first time, the offline reason reminder will not pop up in the interface at this time, so it is necessary to manually check the offline reason of the camera.

Step 2: Check the facts.

In the **Video Management** module, select **Video View > Video Preview**.

Select the preview window and double-click the added camera to the live window, which can play the live normally, indicating that the access is successful.



Figure 4- 21 View Live

Description:

To load the video preview for the first time, you need to download the video plug-in and install it before you can successfully view the video picture.

- 🔄 If the added camera does not appear in the camera list, you can click Refresh Camera List.

Users can customize the new camera grouping. Custom camera groups can be created under Device Management > Grouping Management.

Grouping device: Show all camera groups and cameras in the group and view the live cameras individually or in the whole group.

Full device: Shows all the device of AS1700 and can view the live camera individually.

4.2.3 Group Management

Click **Video Management > Device Management > Group Management**.

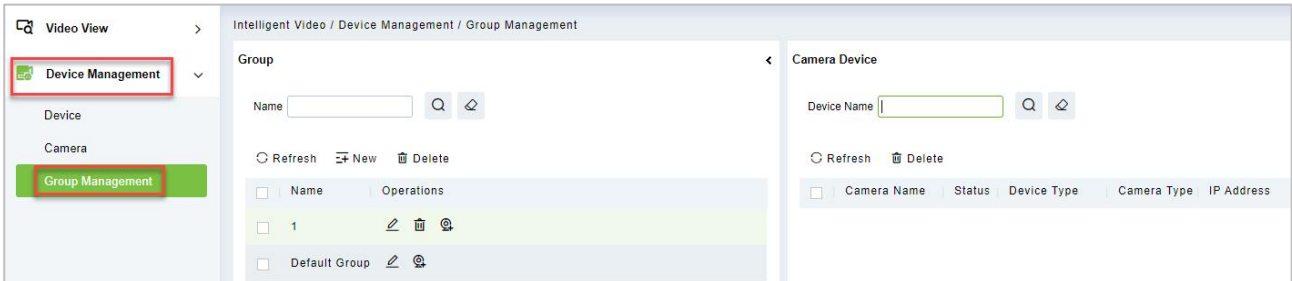

Figure 4- 22 Group Management

4.2.3.1 New

Click **Video Management > Device Management > Group Management**, then select **New**.

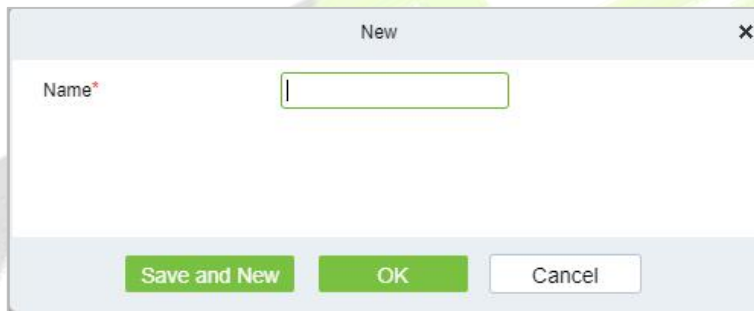

Figure 4- 23 New (Group Management)

Click **OK** to save and exit.

4.2.3.2 Delete

Click **Video Management > Device Management > Group Management**, then select **Delete**.

4.3 Decoding On the Wall

Click **Video Management > Decoding on The Wall**.



Figure 4- 24 Decoding on the Wall

4.3.1 Decoder

Click **Video Management > Decoding on the wall > Decoder**.

4.3.1.1 New (Add Decoder)

Click **Video Management > Decoding on The Wall**, then select **New**.



Figure 4- 25 New (Decoding Wall)

Parameter	Description
Decoder Name	Custom decoder name.
IP Address	IP Address of the decoder
Port	Default port 10200
Type	Select the device model to access the decoder Support PEMXP70 and DEC6109 decoder access
Username	Enter the business username
Password	Enter the business password

Table 4- 12 New

Click **OK** to save and exit, or click **Save and New** to continue.

4.3.1.2 Delete

Click **Video Management > Decoding on The Wall**, then select **Delete**.

4.3.2 TV Wall

Click **Video Management > Decoding on the wall > TV Wall**.

4.3.2.1 New (Create TV Wall)

Click **Video Management > Decoding on the wall > TV Wall**, then select **New (Create TV Wall)**.

Step 1: In the **Video Management** module, select "**Decoding Wall > TV Wall**".

Step 2: Click **Add** to enter the "**Add TV Wall**" page, as shown in Figure 4-26.

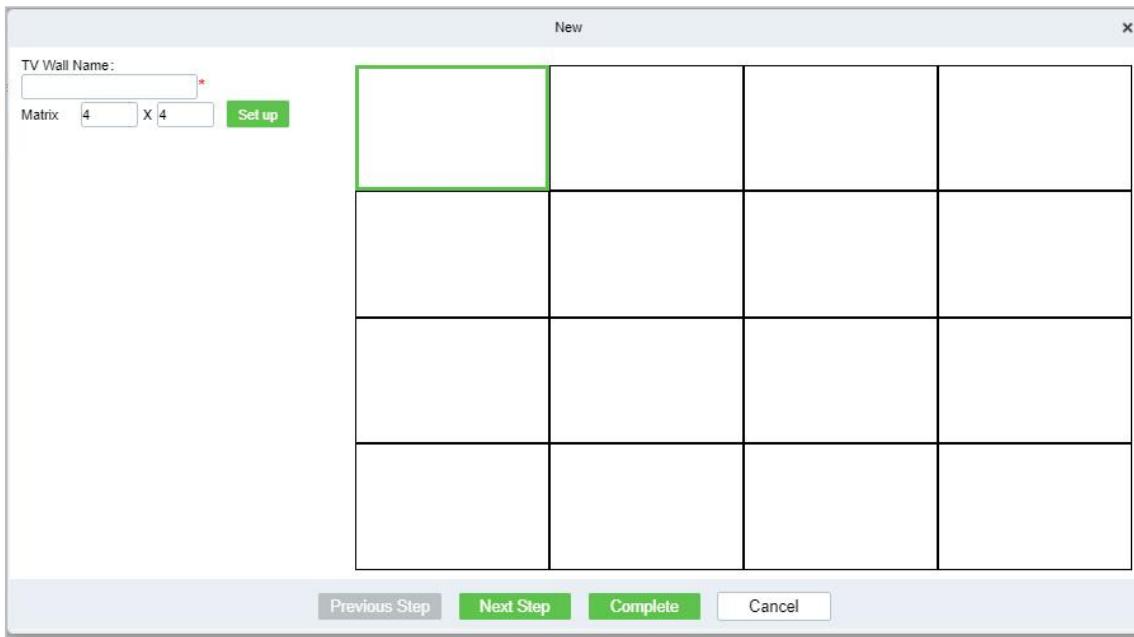

Figure 4- 26 Creating Tv Wall Layout

Step 3: Enter a custom TV Wall Name.

Step 4: In the Matrix Settings box, customize the number of rows and list of input layouts, and click **Settings** to apply the layout.

Description:

Matrix Layout pane settings, supporting a minimum of 1 * 1 and a maximum of 8 * 8.

Step 5: Click next to enter the TV wall binding decoder interface, as shown in Figure 4-27.

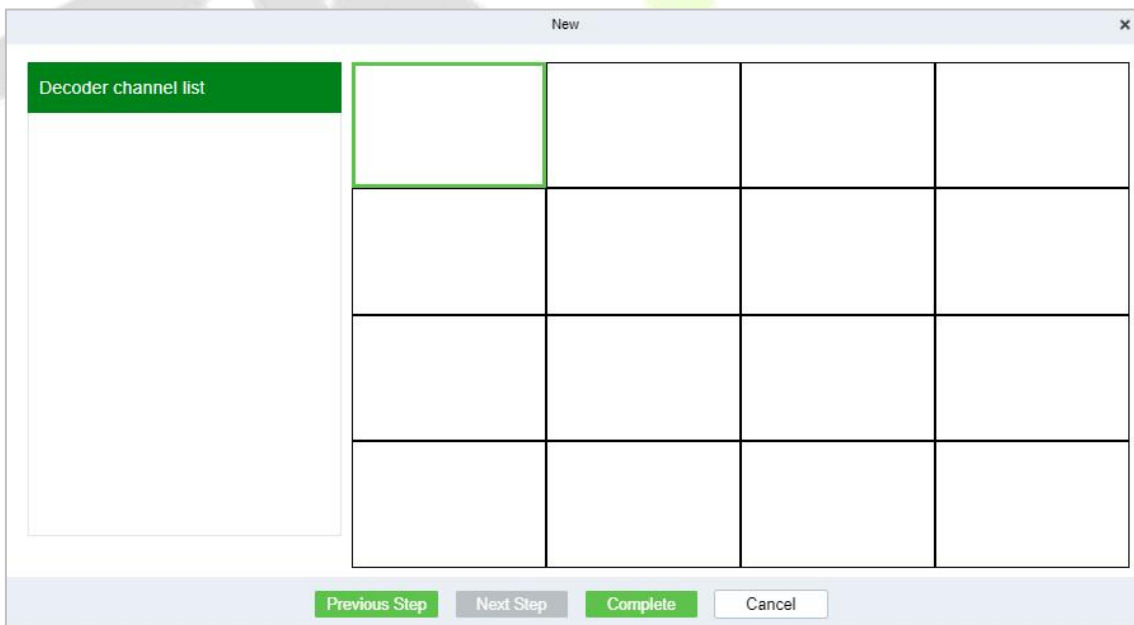

Figure 4- 27 TV Wall Binding Decoder

Step 6: Select the TV wall pane to which you want to add a decoder channel, and then click **Decoder Channel** on the left to complete the binding.

Step 7: Click **Finish** to finish adding the TV wall.

4.3.2.2 TV Wall Live

Precondition:

The TV wall layout has been created and the decoder docking has been completed. See 4.4. 1 Configuring TV Wall for details.

Operating Steps:

Step 1: In **Video Management**, select "**Decoding on the Wall > Large Screen Control**", as shown in Figure 4-28.

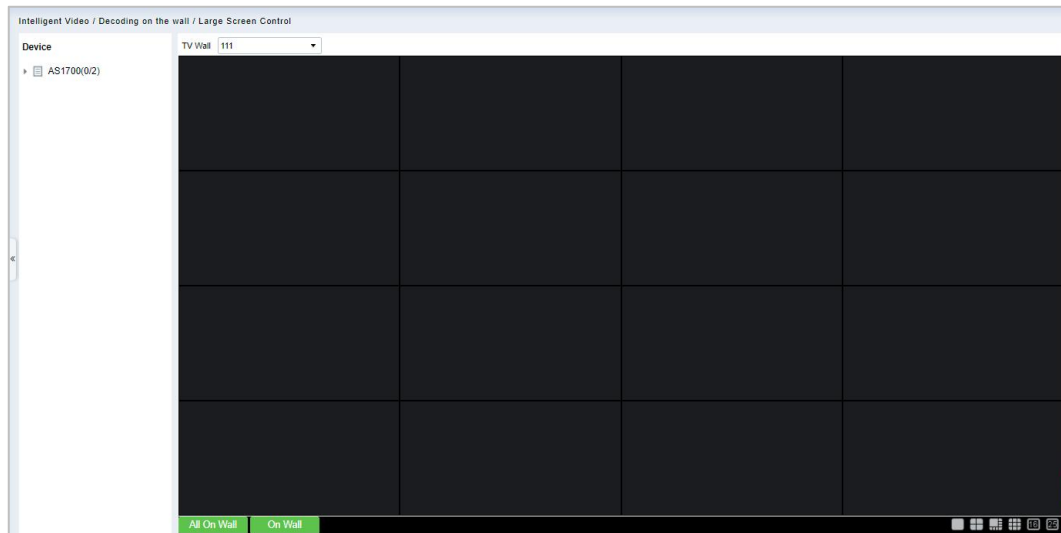

Figure 4- 28 Live Upper Wall

Step 2: Select the created TV wall layout in the TV wall drop-down box.

Step 3: Select a window bound to the decoder channel, click the camera device under the device list to realize the association between the camera and the TV wall window, and then click **Go to the wall** or **Go to the wall all** below to complete the decoder going to the wall operation, so that users can view the live situation on the TV wall screen.

Description:

"Go to the wall" is only for a single window and click "Go to the wall all" when setting split screens.

4.3.2.3 Delete

Click **Video Management > Decoding on the Wall > TV Wall**, then select **Delete**.

4.3.3 Large Screen Control

Click **Video Management > Decoding on the wall > Large Screen Control**.



Figure 4- 29 Large Screen Control

4.4 Search

Click **Video Management**, then select **Search**.

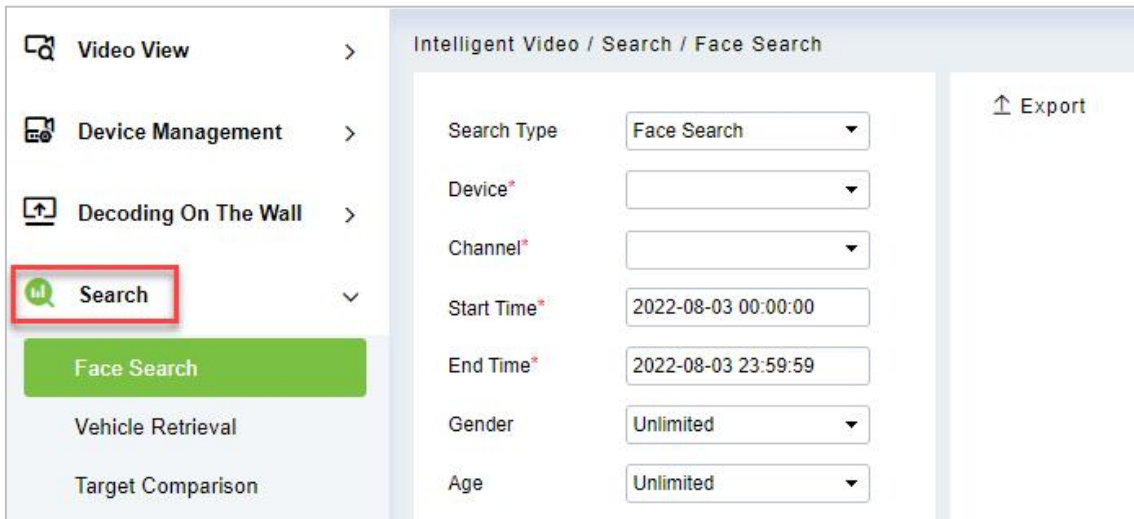

Figure 4- 30 Search

4.4.1 Face Search

Step 1: Click **Video Management** > **Search**, then select **Face Search**.

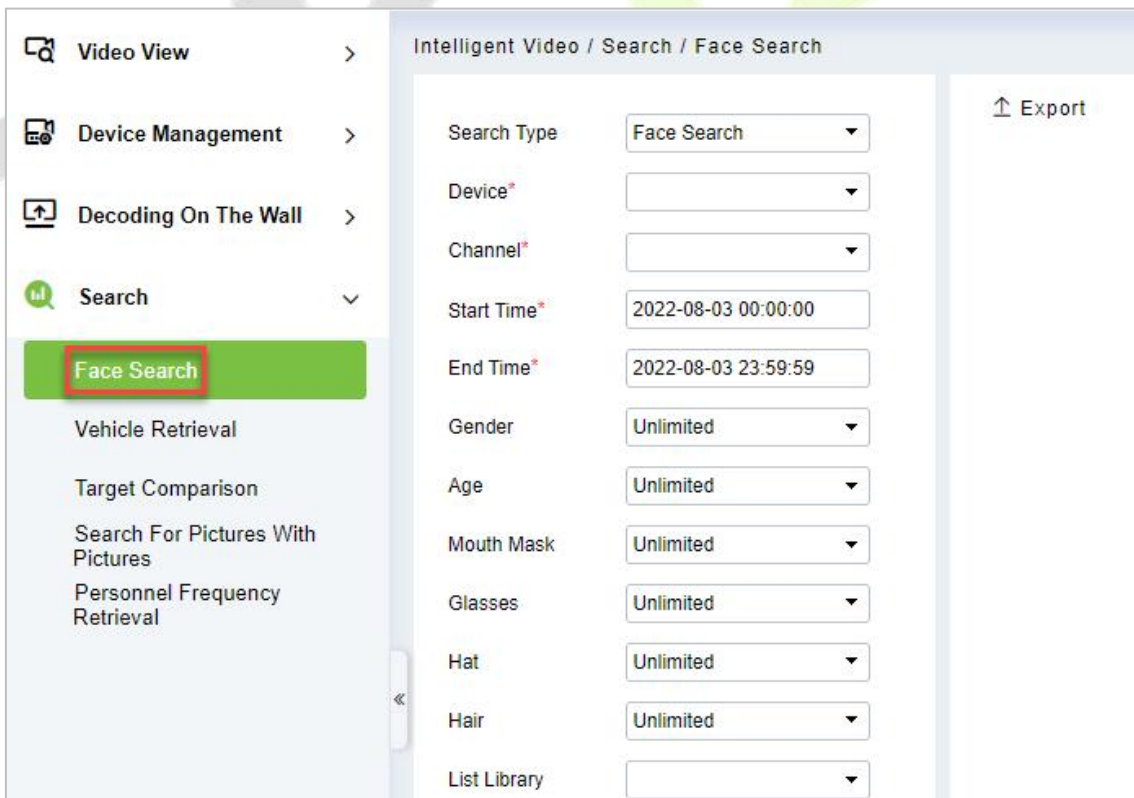

Figure 4- 31 Face Search

Parameter	Description
Search Type	Set Search type as Face Search or Target Overall Search.
Device	Select a device.
Channel	Select an option for channel from list and click Ok.
Start Time	Set start time.
End Time	Set end time.
Gender	Set gender as Unknown, Male, or Female.
Age	Set age as per list: under 18, 18 to 25 years old, 26 to 30 years old, 31 to 35 years old, 36 to 40 years old, 41 to 50 years old, and 51 years old and above.
Mouth Mask	Set to Unknown, Unlimited, Wear mask, and No.
Glasses	Set to Unlimited, Unknown, Have, and No.
Hat	Set to Unknown, Wear a Hat, and No.
Hair	Set to Unlimited, Unknown, long hair, and short hair.
List Library	Select an option from List and click OK.

Table 4- 13 Face Search

Step 2: Click **Search** to complete.

4.4.1.1 Export

Step 1: Click **Video Management > Search > Face Search**, then select **Export**.

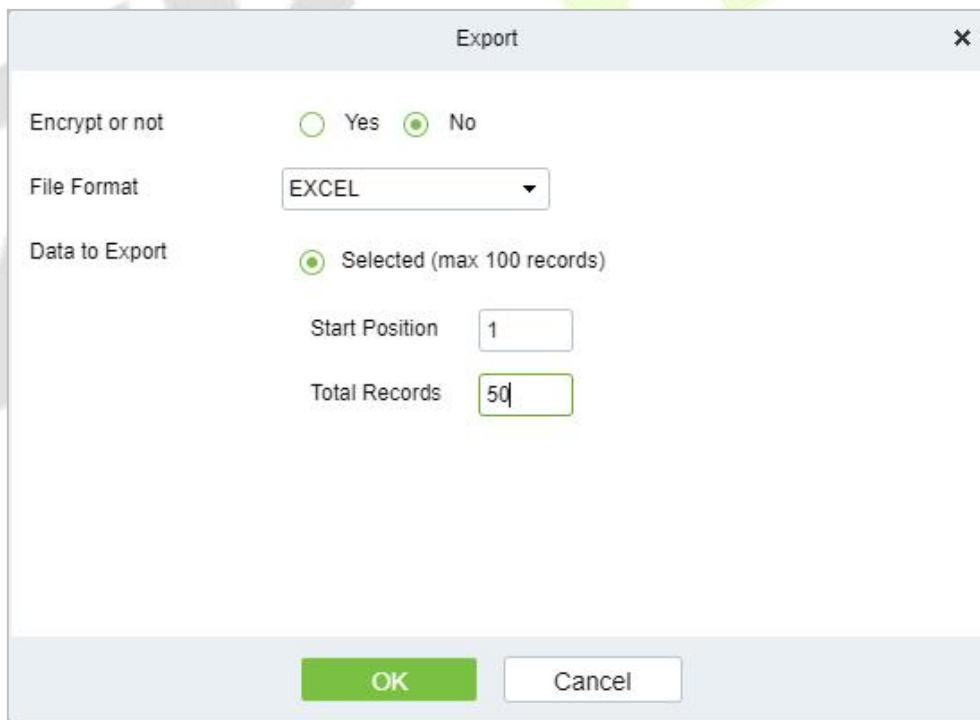

Figure 4- 32 Export

Step 2: Click **OK** to save and exit.

4.4.2 Vehicle Retrieval (AS1700)

Click **Video Management** > **Search**, then select **Vehicle Retrieval**.

The screenshot shows the 'Intelligent Video / Search / Vehicle Retrieval' interface. On the left, a sidebar contains 'Video View', 'Device Management', 'Decoding On The Wall', 'Search', 'Face Search', 'Vehicle Retrieval' (highlighted in green), 'Target Comparison', 'Search For Pictures With Pictures', and 'Personnel Frequency Retrieval'. The main area contains the following search filters:

- Device* (dropdown)
- Channel* (dropdown)
- Start Time* (text input: 2022-08-03 00:00:00)
- End Time* (text input: 2022-08-03 23:59:59)
- Search (checkbox)
- UnknownPlate (checkbox)
- Plate Number (text input)
- Vehicle Brands: (dropdown: Unlimited)
- Vehicle Sub-Model: (dropdown: Unlimited)
- Year Model (dropdown: Unlimited)
- Car Type (dropdown: Unlimited)
- Car Color (dropdown: Unlimited)
- Special Car (dropdown: Unlimited)
- Plate Color (dropdown: Unknown)
- Type Of Plate (dropdown: Unlimited)
- Plate Obscured (dropdown: Unlimited)
- Annual Logo (dropdown: Unlimited)

An 'Export' button is located in the top right corner.

Figure 4- 33 Vehicle Retrieval

Parameter	Description
Device	Select Device.
Channel	Select an option from the list and click OK.
Start/ End Time	Set Start/End Time.
Search Unknown Plate	Select Search Unknown Plate as requirement.
Plate Number	Mention Plate Number.
Vehicle Brands	Select Unlimited.
Vehicle Sub-Model	Select Unlimited.
Year Model	Set year as Unlimited, Unknown and 2013 to 2021.
Car type	Mention Car type as Unknown, Van, Car, Medium Bus, Motorcycle, SUV, Bus, Unlimited, Small truck, and Truck.
Car Color	Set Car color from list as: Unlimited, Unknown, Red, Green, Black, Purple, White, Brown, blue, Pink, Yellow, and Gray.
Special Car	Set as Unlimited, Not Special car, and School Bus.
Plate Color	Set as Unlimited, White, Yellow, Green, Blue, Black, Gradient green, Yellow and Green, Red and Gray.

Parameter	Description
Type of Plate	Set Type of plate as: Personalized License Plate, Single Yellow Card, Single-Layer Military Card, Single Layer Blue card, Double-Decker Military Card, Double Yellow card, Single Layer Black Card, White Armed Police, White Police Sign, Unknown, and Unlimited.
Plate Obscured	Set as Unlimited, Unobstructed License Plate, and Hide the License Plate.
Annual Logo	Set as Unlimited, None, and Yes.

Table 4- 14 Vehicle retrieval

4.4.2.1 Export

Click **Video Management > Search > Vehicle Retrieval**, then select **Export**.

4.4.3 Target Comparison (AS1700)

Step 1: Click **Video Management > Search**, then select **Target Comparison**.

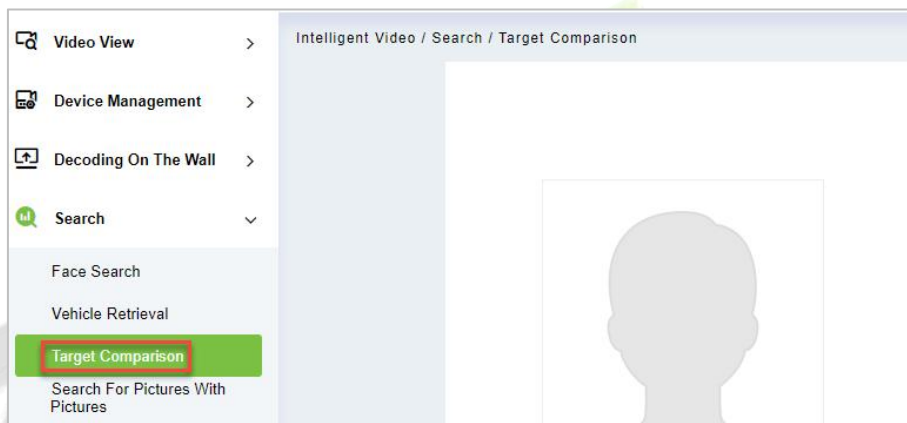

Figure 4- 34 Target Comparison

Step 2: Upload the personnel photos to be compared and click **Compare**.

4.4.4 Search for Pictures with Pictures

Step 1: Click **Video Management > Search**, then select **Search for Pictures with Pictures**.

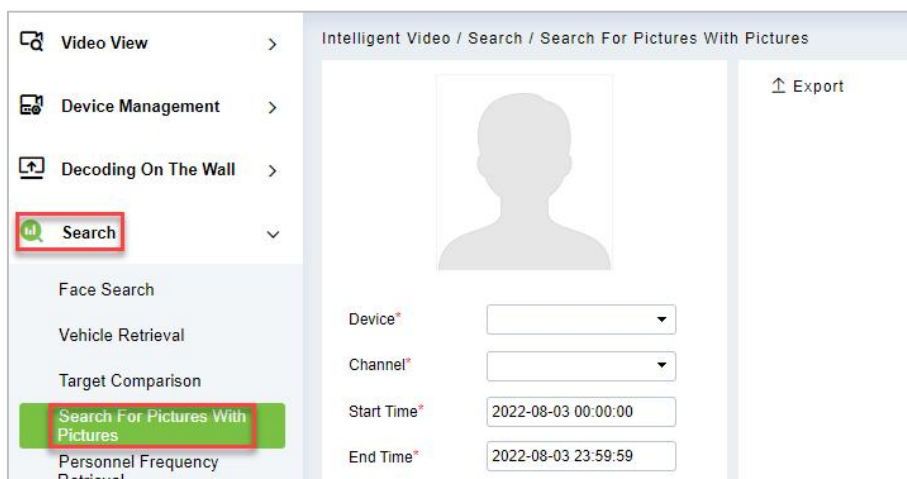

Figure 4- 35 Search for Pictures with Pictures

Step 2: Fill the parameters like **Device, Channel, Start/End Time, and Similarity**, click **Search** to finish.

4.4.4.1 Export

Click **Video Management > Search > Search for Pictures with Pictures**, then select **Export**.

4.4.5 Personnel Frequency Retrieval (NVR800)

Step 1: Click **Video Management > Search**, then select **Personnel Frequency Retrieval**.

Figure 4- 36 Personnel Frequency Retrieval

Parameter	Description
NVR800	Select the device.
Channel	Select Channel as all or single and click OK.
List Library	Select list library from list either all or in single and click OK.
Start Time	Set start time.
End Time	Set end time.
Min Interval(s)	Set the Min Intervals(s).
Similarity	Enter or Set the Similarity.
Gender	Set gender as Unknown, Male, or Female.
Age	Set age as per list: under 18, 18 to 25 years old, 26 to 30 years old, 31 to 35 years old, 36 to 40 years old, 41 to 50 years old, and 51 years old and above.
Mouth Mask	Set to Unknown, Unlimited, Wear mask, and No.
Hair Style	Set to Unlimited, Unknown, long hair, and short hair.

Parameter	Description
Glasses	Set to Unlimited, Unknown, Have, and No.
Hat	Set to Unknown, Wear a Hat, and No.
Maximum Display Quantity	Set a Maximum Display Quantity.

Table 4- 15 Personnel Frequency Retrieval

Step 2: Click **Search** to complete.

4.5 Intelligent

Click **Video Management**, then select **Intelligent**.

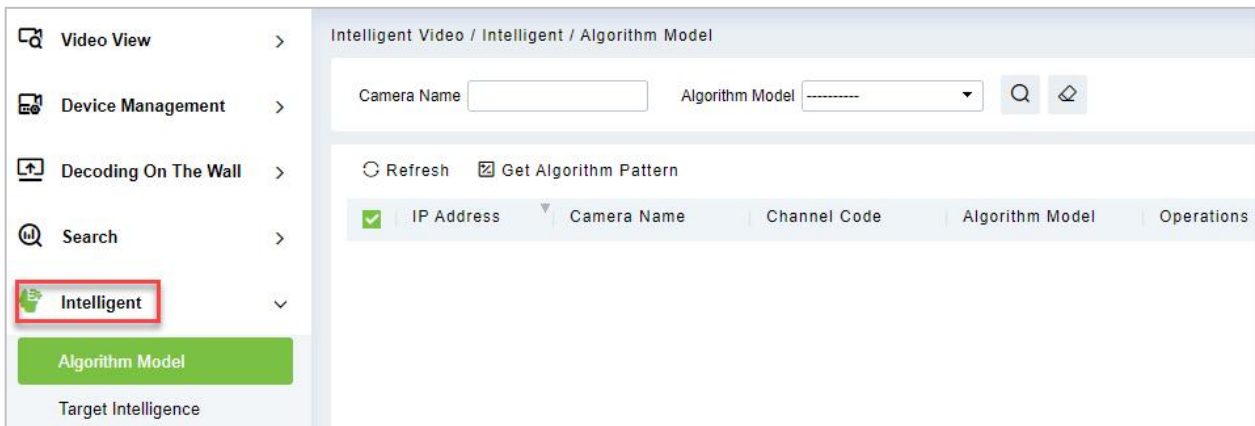

Figure 4- 37 Intelligent

4.5.1 Algorithm Model (AS1700 Supported)

Click **Video Management**> **Intelligent**, then select **Algorithm Model**.

4.5.1.1 Get Algorithm Pattern

Click **Video Management**> **Intelligent** > **Algorithm Model**, then select **Get Algorithm Model**.

4.5.2 Target Intelligence

Click **Video Management**> **Intelligent**, then select **Target Intelligence**.

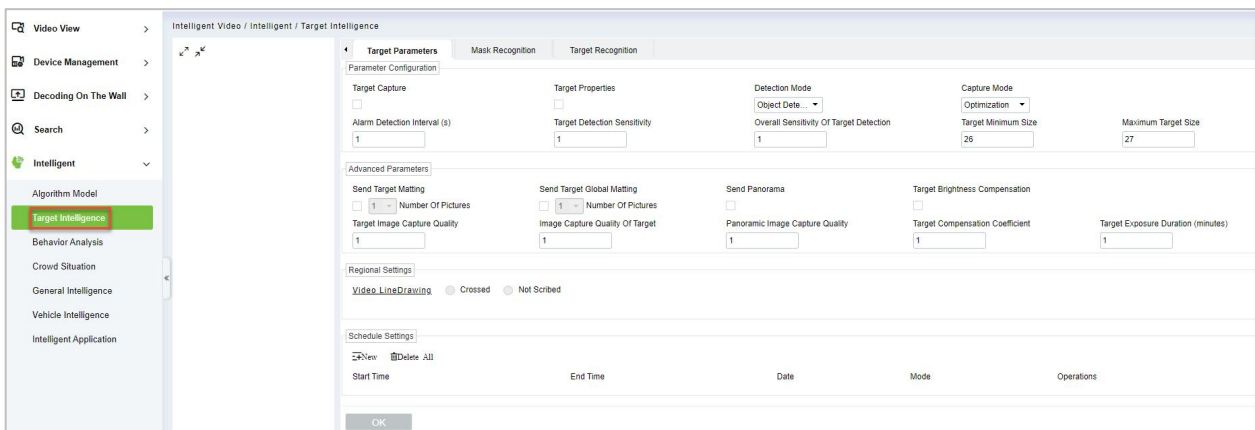

Figure 4- 38 Target Intelligence

4.5.2.1 Target Parameters

In this, parameters like **Parameter Configuration**, **Advanced Parameter**, **Regional Settings**, and **Schedule Settings** are included and can be operated according to requirement.

- Parameter Configuration**

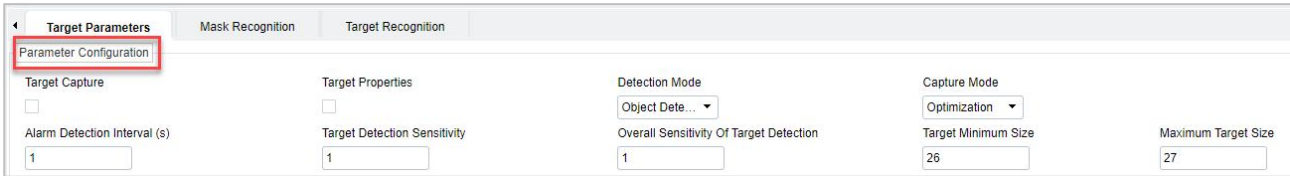

Figure 4- 39 Parameter Configuration

Parameter	Description
Target Capture	Select Target capture as requirement.
Target Properties	Select Target properties as requirement.
Detection Mode	Set Detection mode to Object detection, Overall Target Detection, and Target and Overall Target detection.
Capture Mode	Set Capture Mode to Optimization, Speed, and Timing.
Alarm Detection Interval	Set a number to Alarm detection as requirement.
Target Detection Sensitivity	Set a Target Detection Sensitivity.
Overall Sensitivity of Target Detection	Set an Overall Sensitivity of Target Detection.
Target Minimum Size	Set a range to Target Minimum Size.
Maximum Target Size	Set a range to Maximum Target Size.

Table 4- 16 Parameter Configuration

- Advanced Parameters**

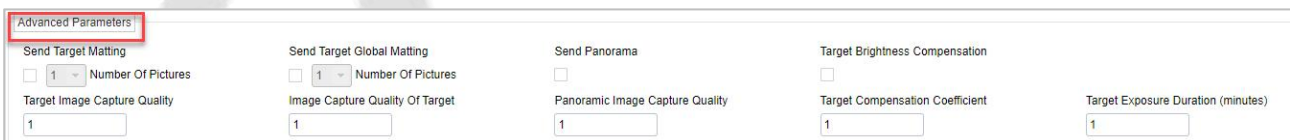

Figure 4- 40 Advanced Parameter

Parameter	Description
Send Target Matting	Set Send Target Matting by selecting Number of Pictures.
Send Target Global Matting	Select Number of pictures to Send Target Global Matting.
Send Panorama	Select panorama as requirement.
Target Brightness Compensation	Select Target Brightness Compensation as requirement.
Target Image Capture Quality	Set Target Image Capture Quality.
Image Capture Quality of Target	Set Image Capture Quality of Target.
Panoramic Image Capture Quality	Set Panoramic Image Capture Quality.
Target Compensation Coefficient	Set Target Compensation Coefficient.
Target Exposure Duration (minutes)	Set Target Exposure Duration (minutes).

Table 4- 17 Advanced Parameter

- **Regional Settings**



Figure 4- 41 Regional Settings

In Regional Settings select **Video Line Drawing** as **Crossed** or **Not Scribed**.

- **Schedule Setting**

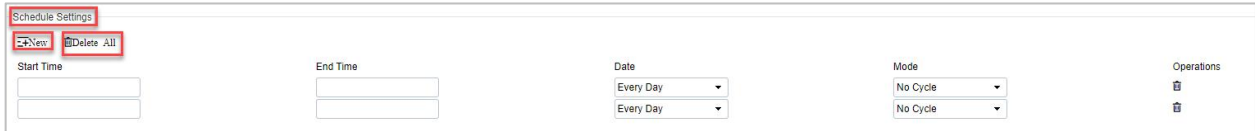



Figure 4- 42 Schedule Setting

- **New**

Click New to add new schedule for Start time, End Time, Date, Mode, and Operations.

- **Delete All**

Click **Delete All** to delete all schedule, if to delete individual one click  to complete delete option.

4.5.2.2 Mask Recognition

- **Parameter Configuration**

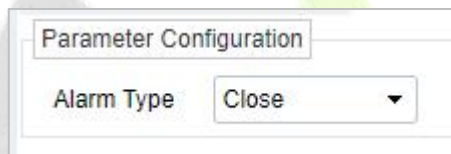

Figure 4- 43 Parameter Configuration

Set **Alarm Type** to **Close**, **No Mask**, and **Have a Mask**.

- **Audible Alert**

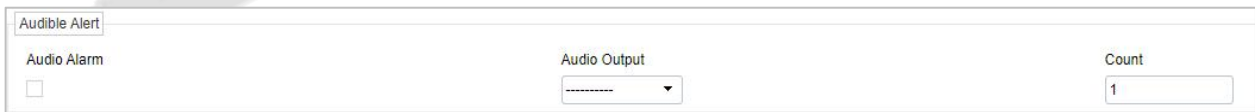

Figure 4- 44 Audible Alert

Set **Audible Alert** in options like **Audio Alarm**, **Audio Output**, and **Count**.

- **Light Flashing Alarm**

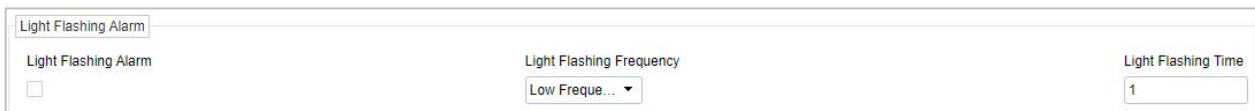

Figure 4- 45 Light Flashing Alarm

Parameter	Description
Light Flashing Alarm	Set Light Flashing Alarm if require.
Light flashing Frequency	Set Light flashing Frequency as Low Frequency, Hight Frequency, Medium Frequency, and Steady On.

Parameter	Description
Light flashing time	Set Light flashing time if require.

Figure 4- 46 Light Flashing Alarm

● **Schedule Settings**

Figure 4- 47 Schedule Settings

● **New**

Click **New** to add new schedule for Start time, End Time, Date, Mode, and Operations.

● **Delete All**

Click **Delete All** to delete all schedule, if to delete individual one Click  to complete delete option.

4.5.2.3 Target Recognition

● **Parameter Configuration**

It includes Enable Target recognition, Target Parameter Model, Target Recognition Model, and Usage Mode.

Figure 4- 48 Parameter Configuration

Click **OK** to save and exit.

4.5.3 Behavior Analysis (AS1700 Supported)

4.5.3.1 IGT Alarm Config

Setting	Enable	Disable
Enable Behavioural	<input type="radio"/>	<input checked="" type="radio"/>
Send Metadata	<input type="radio"/>	<input checked="" type="radio"/>
Perimeter Enhance	<input type="radio"/>	<input checked="" type="radio"/>
Alert Inhibition	<input type="radio"/>	<input checked="" type="radio"/>
Alarm Pic AiInfo	<input type="radio"/>	<input checked="" type="radio"/>
Shadow Removal Mode	Weak Shadow	
Detection Sensitivity	Low Sensitivity	
Background Update Rate	Low	
Min Target Size	5	5
Max Target Size	5	5

Figure 4- 49 IGT Alarm Configuration

4.5.3.2 Intrusion Detection

● Parameter Configuration

Target Detect:	<input type="checkbox"/> Pedestrian	<input type="checkbox"/> Motor Vehicles	<input type="checkbox"/> Non-motorized Vehicles
Alarm Detection Interval (s)	Recognize Mode		Sensitivity
1	Center		1

Figure 4- 50 Parameter Configuration

Set **Target Detect** as **Pedestrian, Motor vehicles, and Non-motorized Vehicles.**

Set **Alarm Detection Interval(s).**

Set **Recognize Mode** as **Center, Bottom, and Top.**

Set **Sensitivity** as **requirement.**

● Audible Alert

Audio Alarm	Audio Output	Count
<input checked="" type="radio"/> Enable <input type="radio"/> Disable		1

Figure 4- 51 Audible Alert

Set Audio Alarm to **Enable** or **Disable.**

Set **Audio Output.**

Set **Count** for Audible Alert.

● **Light Flashing Alarm**

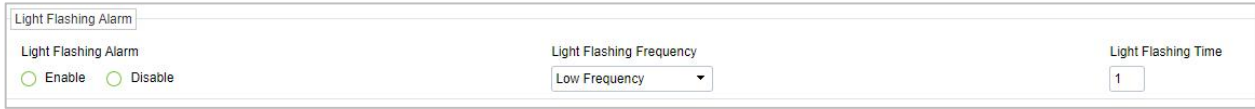

Figure 4- 52 Light Flashing Alarm

Set Light Flashing Alarm to **Enable** or **Disable**.

Set Light Flashing Frequency to **Low Frequency, Medium frequency, High frequency, and Steady On**.

Set **Light Flashing time** as required.

● **Regional Settings**

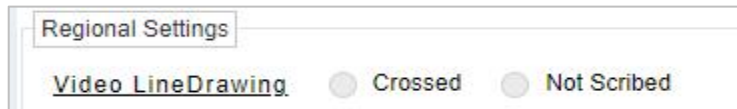

Figure 4- 53 Regional Settings

Set **Video Line Drawing** as **Crossed** or **Not Scribed**.

● **Schedule Settings**

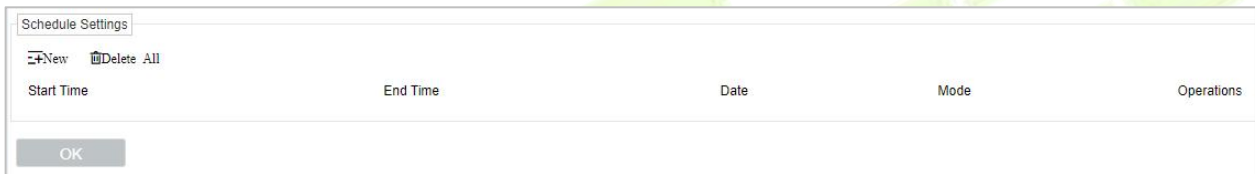



Figure 4- 54 Schedule Settings

● **New**

Click New to add new schedule for Start time, End Time, Date, Mode, and Operations.

● **Delete All**

Click **Delete All** to delete all schedule, if to delete individual one-click  to complete delete option.

4.5.3.3 Perimeter Line

● **Parameter Configuration**

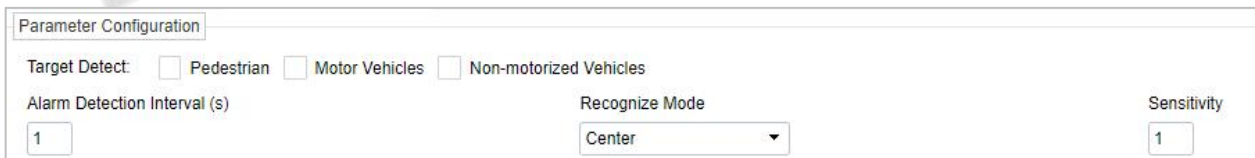

Figure 4- 55 Parameter Configuration

Set **Target Detect** as **Pedestrian, Motor vehicles, and Non-motorized Vehicles**.

Set **Alarm Detection Interval(s)**.

Set **Recognize Mode** as **Center, Bottom, and Top**.

Set **Sensitivity** as **requirement**.

● **Audible Alert**

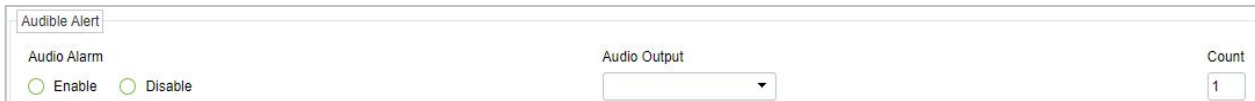

Figure 4- 56 Audible Alert

Set Audio Alarm to **Enable** or **Disable**.

Set **Audio Output**.

Set **Count** for Audible Alert.

● **Light Flashing Alarm**



Figure 4- 57 Light Flashing Alarm

Set Light Flashing Alarm to **Enable** or **Disable**.

Set Light Flashing Frequency to **Low Frequency, Medium frequency, High frequency, and Steady On**.

Set **Light Flashing time** as required.

● **Regional Settings**

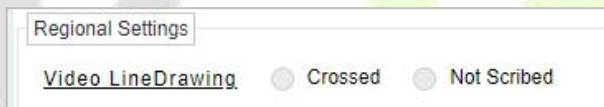

Figure 4- 58 Regional Settings

Set **Video Line Drawing** as **Crossed** or **Not Scribed**.

● **Schedule Settings**



Figure 4- 59 Schedule Settings

● **New**

Click New to add new schedule for Start time, End Time, Date, Mode, and Operations.

● **Delete All**

Click **Delete All** to delete all schedule, if to delete individual one Click  to complete delete option.

4.5.3.4 Region Entrance Detection

● Parameter Configuration

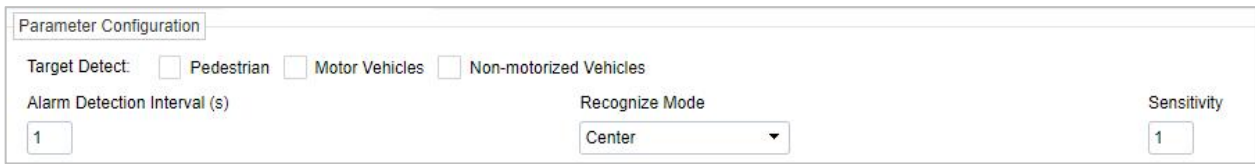

Figure 4- 60 Parameter Configuration

Set **Target Detect** as **Pedestrian**, **Motor vehicles**, and **Non-motorized Vehicles**.

Set **Alarm Detection Interval(s)**.

Set **Recognize Mode** as **Center**, **Bottom**, and **Top**.

Set **Sensitivity** as requirement.

● Audible Alert

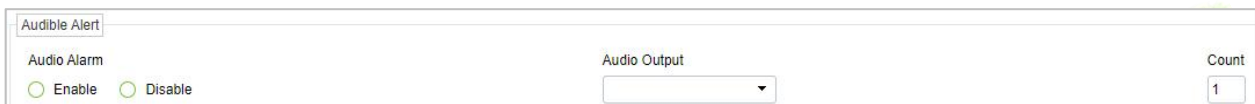

Figure 4- 61 Audible Alert

Set Audio Alarm to **Enable** or **Disable**.

Set **Audio Output**.

Set **Count** for Audible Alert.

● Light Flashing Alarm

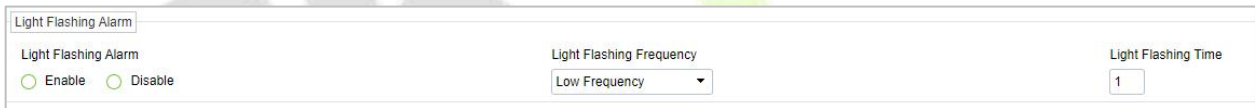

Figure 4- 62 Light Flashing Alarm

Set Light Flashing Alarm to **Enable** or **Disable**.

Set Light Flashing Frequency to **Low Frequency**, **Medium frequency**, **High frequency**, and **Steady On**.

Set **Light Flashing time** as required.

● Regional Settings

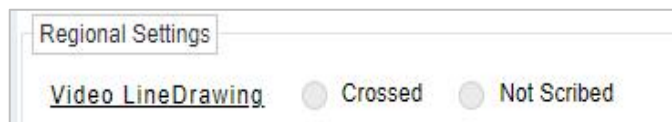

Figure 4- 63 Regional Settings

Set **Video Line Drawing** as **Crossed** or **Not Scribed**.

● Schedule Settings



Figure 4- 64 Schedule Settings

● **New**

Click **New** to add new schedule for Start time, End Time, Date, Mode, and Operations.

● **Delete All**

Click **Delete All** to delete all schedule, if to delete individual one Click  to complete delete option.

4.5.3.5 Region Exiting

● **Parameter Configuration**

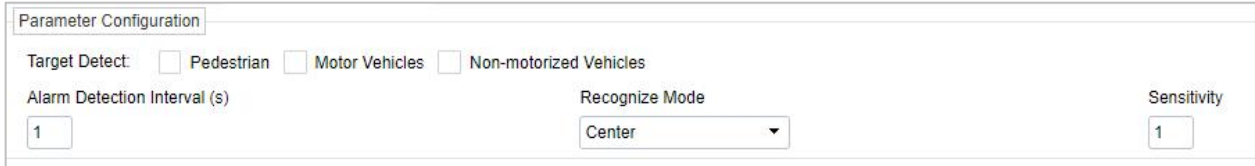

The screenshot shows a 'Parameter Configuration' window with the following settings:

- Target Detect: Pedestrian Motor Vehicles Non-motorized Vehicles
- Alarm Detection Interval (s):
- Recognize Mode:
- Sensitivity:

Figure 4- 65 Parameter Configuration

Set **Target Detect** as **Pedestrian, Motor vehicles, and Non-motorized Vehicles.**

Set **Alarm Detection Interval(s).**

Set **Recognize Mode** as **Center, Bottom, and Top.**

Set **Sensitivity** as **requirement.**

● **Audible Alert**

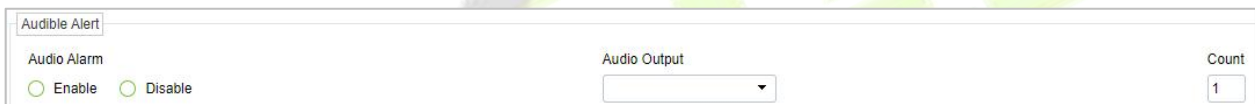

The screenshot shows an 'Audible Alert' window with the following settings:

- Audio Alarm: Enable Disable
- Audio Output:
- Count:

Figure 4- 66 Audible Alert

Set Audio Alarm to **Enable** or **Disable.**

Set **Audio Output.**

Set **Count** for Audible Alert.

● **Light Flashing Alarm**



The screenshot shows a 'Light Flashing Alarm' window with the following settings:

- Light Flashing Alarm: Enable Disable
- Light Flashing Frequency:
- Light Flashing Time:

Figure 4- 67 Light Flashing Alarm

Set **Light Flashing Alarm** to **Enable** or **Disable.**

Set Light Flashing Frequency to **Low Frequency, Medium frequency, High frequency, and Steady On.**

Set **Light Flashing time** as required.

● **Regional Settings**

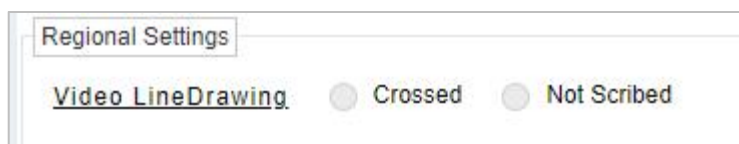

The screenshot shows a 'Regional Settings' window with the following settings:

- Video LineDrawing: Crossed Not Scribed

Figure 4- 68 Regional Settings

Set **Video Line Drawing** as **Crossed** or **Not Scribed.**

● **Schedule Settings**



Figure 4- 69 Schedule Settings

● **New**

Click **New** to add new schedule for Start time, End Time, Date, Mode, and Operations.

● **Delete All**

Click **Delete All** to delete all schedule, if to delete individual one Click  to complete delete option.

4.5.3.6 Object Left

● **Parameter Configuration**



Figure 4- 70 Parameter Configuration

Set **Alarm Detection Interval(s)**.

Set **Recognize Mode** as **Center, Bottom, and Top**.

Set **Sensitivity** as requirement.

Set **Alarm Tolerance Time(second)**.

● **Audible Alert**

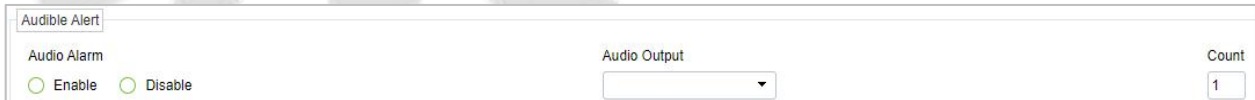

Figure 4- 71 Audible Alert

Set Audio Alarm to **Enable** or **Disable**.

Set **Audio Output**.

Set **Count** for Audible Alert.

● **Light Flashing Alarm**

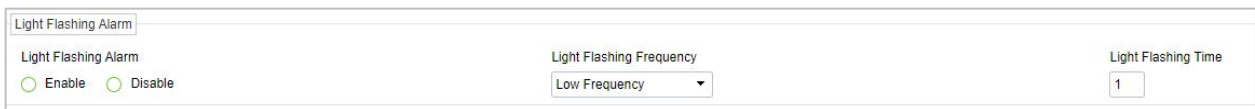

Figure 4- 72

Figure 4-64 Light Flashing Alarm

Set Light Flashing Alarm to **Enable** or **Disable**.

Set Light Flashing Frequency to **Low Frequency, Medium frequency, High frequency, and Steady On**.

Set **Light Flashing time** as required.

● **Regional Settings**

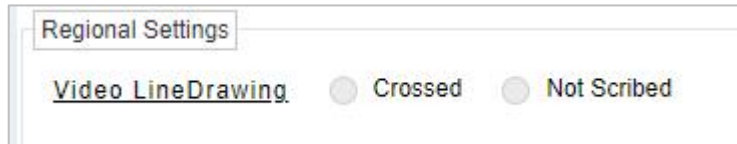

Figure 4- 73 Regional Settings.

Set **Video Line Drawing** as **Crossed** or **Not Scribed**.

● **Schedule Settings**



Figure 4- 74 Schedule Settings

● **New**

Click New to add new schedule for Start time, End Time, Date, Mode, and Operations.

● **Delete All**

Click **Delete All** to delete all schedule, if to delete individual one-click  to complete delete option.

4.5.3.7 Object Remove

● **Parameter Configuration**

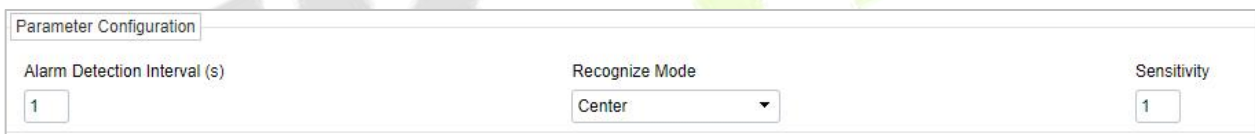

Figure 4- 75 Parameter Configuration

Set **Alarm Detection Interval(s)**.

Set **Recognize Mode** as **Center, Bottom, and Top**.

Set **Sensitivity** as **requirement**.

● **Audible Alert**

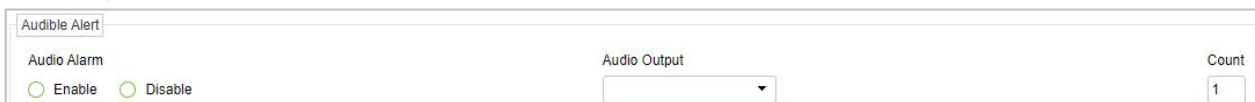

Figure 4- 76 Audible Alert

Set Audio Alarm to **Enable** or **Disable**.

Set **Audio Output**.

Set **Count** for Audible Alert.

● **Light Flashing Alarm**



Figure 4- 77 Light Flashing Alarm

Set Light Flashing Alarm to **Enable** or **Disable**.

Set Light Flashing Frequency to **Low Frequency, Medium frequency, High frequency, and Steady On**.

Set **Light Flashing time** as required.

● **Regional Settings**

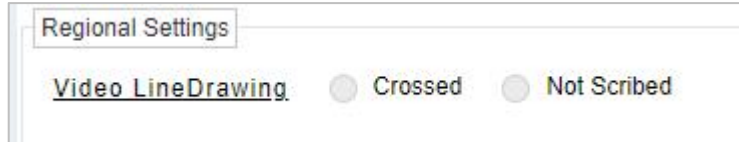

Figure 4- 78 Regional Settings.

Set **Video Line Drawing** as **Crossed** or **Not Scribed**.

● **Schedule Settings**

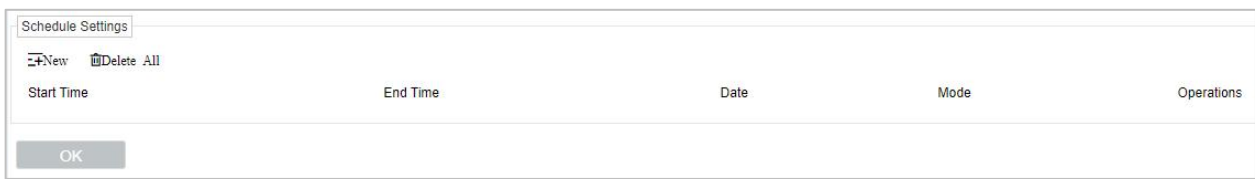



Figure 4- 79 Schedule Settings

● **New**

Click New to add new schedule for Start time, End Time, Date, Mode, and Operations.

● **Delete All**

Click **Delete All** to delete all schedule, if to delete individual one Click  to complete delete option.

4.5.3.8 Loitering

● **Parameter Configuration**



Figure 4- 80 Parameter Configuration

Set **Target Detect** as **Pedestrian, Motor vehicles, and Non-motorized Vehicles**.

Set **Alarm Detection Interval(s)**.

Set **Recognize Mode** as **Center, Bottom, and Top**.

Set **Sensitivity** as **requirement**.

Set **Alarm Tolerance Time(second)**.

● **Audible Alert**

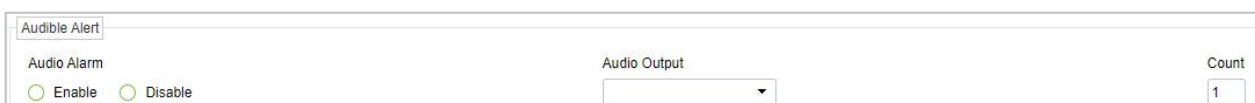

Figure 4- 81 Audible Alert

Set Audio Alarm to **Enable** or **Disable**.

Set **Audio Output**.

Set **Count** for Audible Alert.

● **Light Flashing Alarm**

Figure 4- 82 Light Flashing Alarm

Set Light Flashing Alarm to **Enable** or **Disable**.

Set Light Flashing Frequency to **Low Frequency, Medium frequency, High frequency, and Steady On**.

Set **Light Flashing time** as required.

● **Regional Settings**

Figure 4- 83 Regional Settings

Set **Video Line Drawing** as **Crossed** or **Not Scribed**.

● **Schedule Settings**

Figure 4- 84 Schedule Settings

● **New**

Click **New** to add new schedule for Start time, End Time, Date, Mode, and Operations.

● **Delete All**

Click **Delete All** to delete all schedule, if to delete individual one Click  to complete delete option.

4.5.3.9 Fast Move

● **Parameter Configuration**

Figure 4- 85 Fast Move

Set **Alarm Detection Interval(s)**.

Set **Recognize Mode** as **Center, Bottom, and Top**.

Set **Sensitivity** as **requirement**.

● Audible Alert

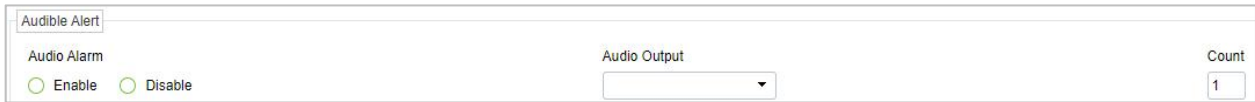

Figure 4- 86 Audible Alert

Set Audio Alarm to **Enable** or **Disable**.

Set **Audio Output**.

Set **Count** for Audible Alert.

● Light Flashing Alarm



Figure 4- 87 Light Flashing Alarm

Set Light Flashing Alarm to **Enable** or **Disable**.

Set Light Flashing Frequency to **Low Frequency, Medium frequency, High frequency, and Steady On**.

Set **Light Flashing time** as required.

● Regional Settings

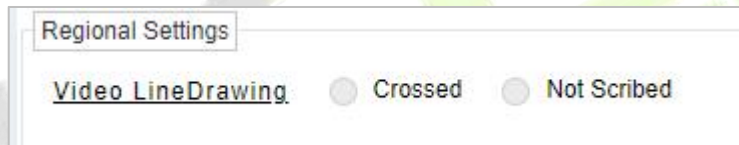

Figure 4- 88 Regional Settings

Set **Video Line Drawing** as **Crossed** or **Not Scribed**.

● Schedule Settings



Figure 4- 89 Schedule Settings

● New

Click New to add new schedule for Start time, End Time, Date, Mode, and Operations.

● Delete All

Click **Delete All** to delete all schedule, if to delete individual one Click  to complete delete option.

4.5.3.10 Electric Bike

● Parameter Configuration

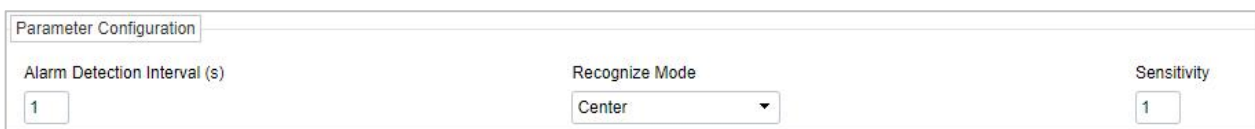

Figure 4- 90 Parameter Configuration

Set **Alarm Detection Interval(s)**.

Set **Recognize Mode** as **Center, Bottom, and Top**.

Set **Sensitivity** as requirement.

● **Audible Alert**

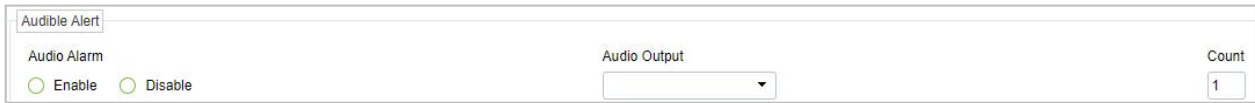

Figure 4- 91 Audible Alert

Set Audio Alarm to **Enable** or **Disable**.

Set **Audio Output**.

Set **Count** for Audible Alert.

● **Light Flashing Alarm**



Figure 4- 92 Light Flashing Alarm

Set Light Flashing Alarm to **Enable** or **Disable**.

Set Light Flashing Frequency to **Low Frequency, Medium frequency, High frequency, and Steady On**.

Set **Light Flashing time** as required.

● **Regional Settings**

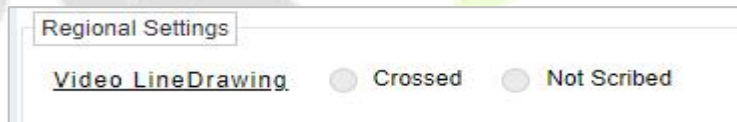

Figure 4- 93 Regional Settings

Set **Video Line Drawing** as **Crossed** or **Not Scribed**.

● **Schedule Settings**

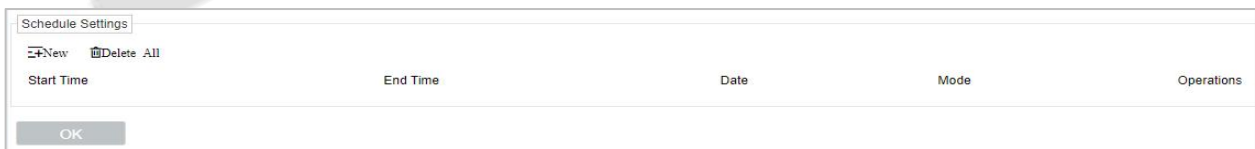



Figure 4- 94 Schedule Settings

● **New**

Click New to add new schedule for Start time, End Time, Date, Mode, and Operations.

● **Delete All**

Click **Delete All** to delete all schedule, if to delete individual one Click  to complete delete option.

4.5.4 Crowd Situation

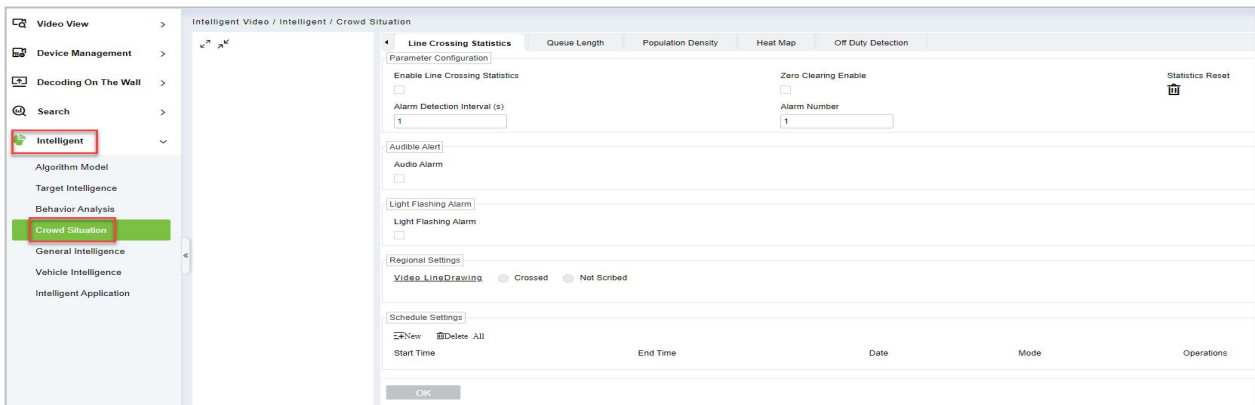

Figure 4- 95 Crowd Situation

4.5.4.1 Line Crossing Status

- **Parameter Configuration**

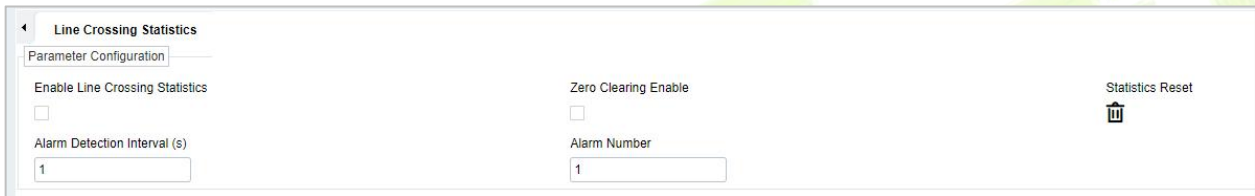

Figure 4- 96 Parameter Configuration

Set Parameters like **Enable Line Crossing Statistics, Zero Cleaning Enable, Statistics Reset, Alarm Detection Interval(s),** and **Alarm Number.**

- **Audible Alert**



Figure 4- 97 Audio Alert

- **Light Flashing Alarm**

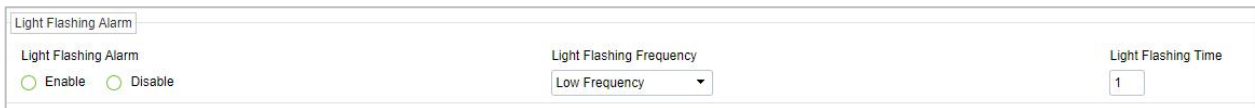

Figure 4- 98 Light Flashing Alarm

Set Light Flashing Alarm to **Enable** or **Disable**.

Set Light Flashing Frequency to **Low Frequency, Medium frequency, High frequency,** and **Steady On.**

Set **Light Flashing time** as required.

- **Regional Settings**

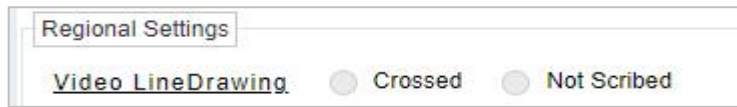

Figure 4- 99 Regional Settings.

Set **Video Line Drawing** as **Crossed** or **Not Scribed**.

● **Schedule Settings**



Figure 4- 100 Schedule Settings

● **New**

Click **New** to add new schedule for Start time, End Time, Date, Mode, and Operations.

● **Delete All**

Click **Delete All** to delete all schedule, if to delete individual one-click  to complete delete option.

4.5.4.2 Queue Length

● **Parameter Configuration**

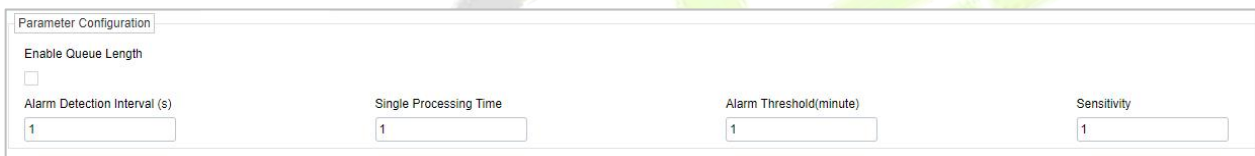

Figure 4- 101 Queue Length

Set Parameters like **Enable Queue Length**, **Alarm Detection Interval(s)**, **Single Processing Time**, **Alarm Threshold(minute)**, and **Sensitivity**.

● **Audible Alert**



Figure 4- 102 Audio Alert

● **Light Flashing Alarm**



Figure 4- 103 Light Flashing Alarm

Set Light Flashing Alarm to **Enable** or **Disable**.

Set Light Flashing Frequency to **Low Frequency**, **Medium frequency**, **High frequency**, and **Steady On**.

Set **Light Flashing time** as required.

● **Regional Settings**

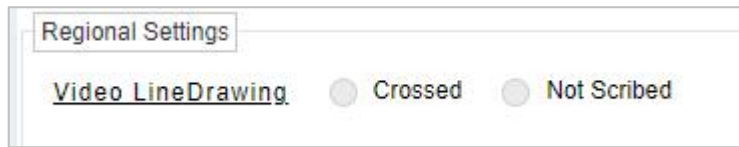

Figure 4- 104 Regional Settings

Set **Video Line Drawing** as **Crossed** or **Not Scribed**.

● **Schedule Settings**



Figure 4- 105 Schedule Settings

● **New**

Click **New** to add new schedule for Start time, End Time, Date, Mode, and Operations.

● **Delete All**

Click **Delete All** to delete all schedule, if to delete individual one Click  to complete delete option.

4.5.4.3 Population Density

● **Parameter Configuration**



Figure 4- 106 Parameter Configuration

Set Parameters like **Enable Population Density**, **Alarm Detection Interval(s)**, **Alarm Threshold(people)**, and **Sensitivity**.

● **Audible Alert**



Figure 4- 107 Audible Alert

● **Light Flashing Alarm**

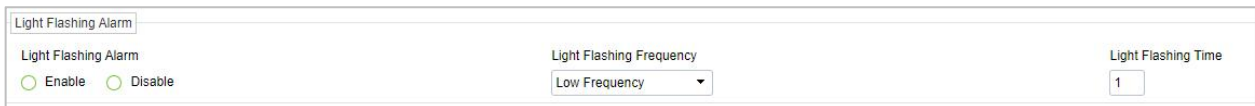

Figure 4- 108 Light Flashing Alarm

Set Light Flashing Alarm to **Enable** or **Disable**.

Set Light Flashing Frequency to **Low Frequency**, **Medium frequency**, **High frequency**, and **Steady On**.

Set **Light Flashing time** as required.

● **Regional Settings**



Figure 4- 109 Regional Settings

Set **Video Line Drawing** as **Crossed** or **Not Scribered**.

● **Schedule Settings**



Figure 4- 110 Schedule Settings

● **New**

Click New to add new schedule for Start time, End Time, Date, Mode, and Operations.

● **Delete All**

Click **Delete All** to delete all schedule, if to delete individual one Click  to complete delete option.

4.5.4.4 Heat Map

● **Parameter Configuration**



Figure 4- 111 Parameter Configuration

Set Parameters Like **Enable Heat Map** and **Send Metadata**.

● **Regional Settings**

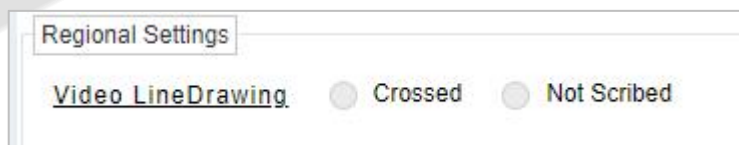

Figure 4- 112 Regional Settings

Set **Video Line Drawing** as **Crossed** or **Not Scribered**.

4.5.4.5 Off Duty Detection

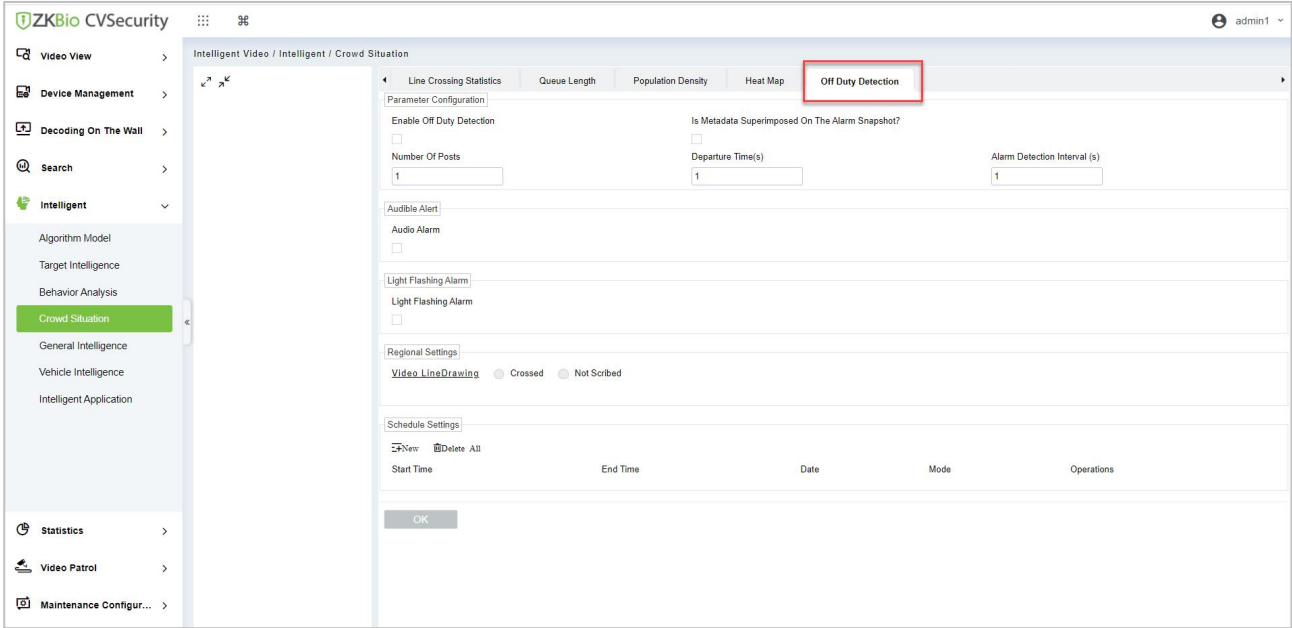

Figure 4- 113 Regional Settings

- **Parameter Configuration**

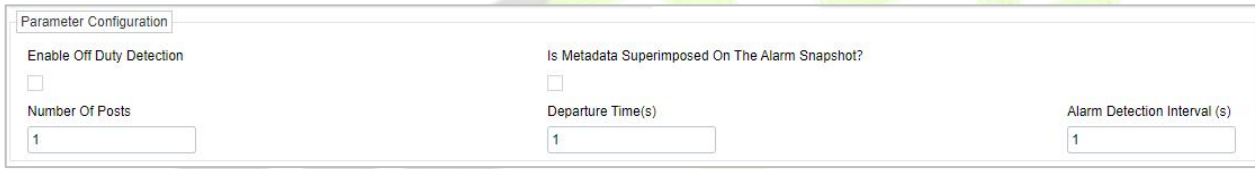

Figure 4- 114 Parameter Configuration

Set Parameters like **Enable Off Duty Detection**, **Is Metadata Superimposed on The Alarm Snapshot**, **Number of Posts**, **Departure Time**, and **Alarm Detection Interval(s)**.

- **Audible Alert**



Figure 4- 115 Audio Alert

- **Light Flashing Alarm**



Figure 4- 116 Light Flashing Alarm

Set Light Flashing Alarm to **Enable** or **Disable**.

Set Light Flashing Frequency to **Low Frequency**, **Medium frequency**, **High frequency**, and **Steady On**.

Set **Light Flashing time** as required.

● **Regional Settings**

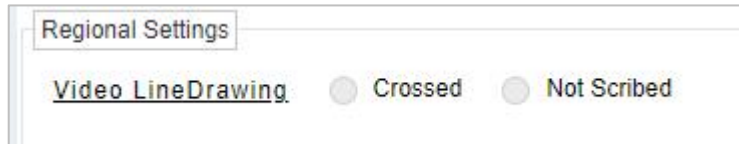

Figure 4- 117 Regional Settings

Set **Video Line Drawing** as **Crossed** or **Not Scribed**.

● **Schedule Settings**



Figure 4- 118 Schedule Settings

● **New**

Click New to add new schedule for Start time, End Time, Date, Mode, and Operations.

● **Delete All**

Click **Delete All** to delete all schedule, if to delete individual one Click  to complete delete option.

Click **OK** to save and exit.

4.5.5 General Intelligence (AS1700/ZKNVR Supported)

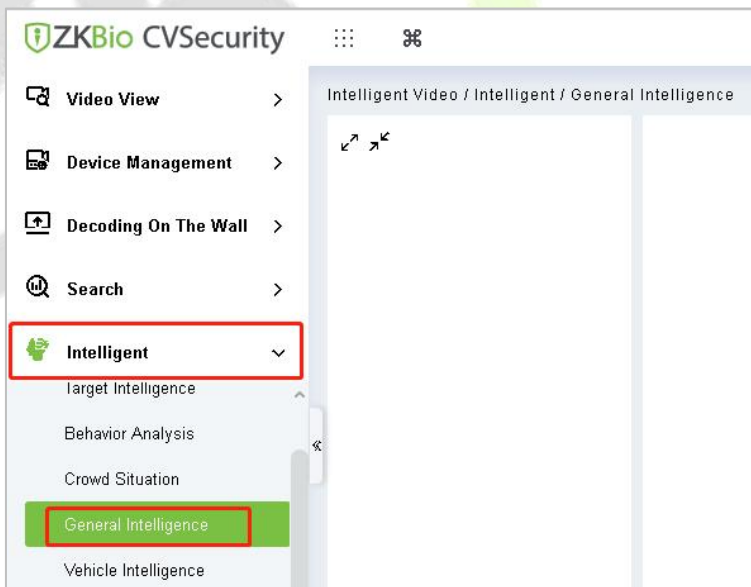

Figure 4- 119 General Intelligence

● **Privacy Protection Setting**

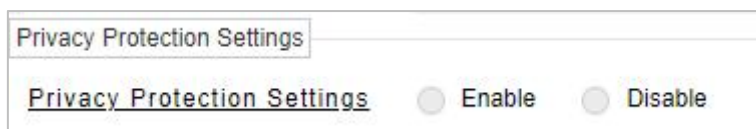

Figure 4- 120 Privacy Protection Setting

Set Privacy Protection Setting as **Enable** or **Disable**.

● **Parameter Configuration**

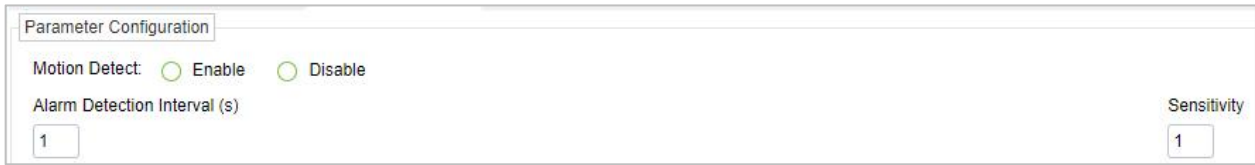

Figure 4- 121 Parameter Configuration

● **Audible Alert**



Figure 4- 122 Audible Alert

● **Light Flashing Alarm**

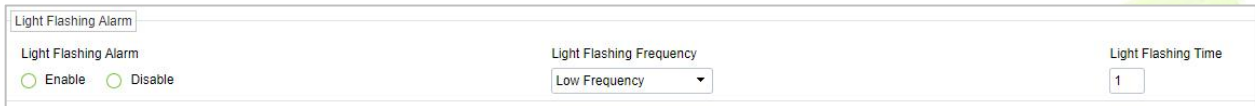

Figure 4- 123 Light Flashing Alarm

Set Light Flashing Alarm to **Enable** or **Disable**.

Set Light Flashing Frequency to **Low Frequency, Medium frequency, High frequency, and Steady On**.

Set **Light Flashing time** as required.

● **Regional Settings**

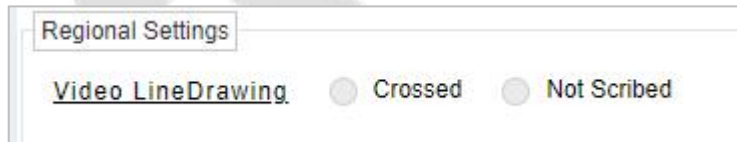

Figure 4- 124 Regional Settings

Set **Video Line Drawing** as **Crossed** or **Not Scribed**.

● **Schedule Settings**

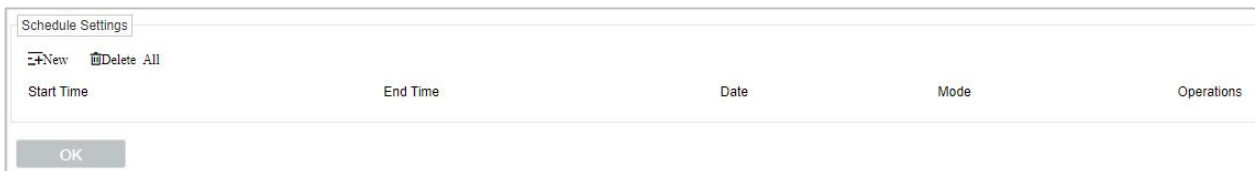



Figure 4- 125 Schedule Settings

● **New**

Click **New** to add new schedule for Start time, End Time, Date, Mode, and Operations.

● **Delete All**

Click **Delete All** to delete all schedule, if to delete individual one Click  to complete delete option.

4.5.5.1 Lens Blocking

● Parameter Configuration

Figure 4- 126 Parameter Configuration

Set Parameters like **Enable** or **Disable Lens Blocking**, **Alarm Detection Interval(s)**, and **Sensitivity**.

● Audible Alert

Figure 4- 127 Audible Alert

Set Audio Alarm to **Enable** or **Disable**.

Set **Audio Output**.

Set **Count** for Audible Alert.

● Light Flashing Alarm

Figure 4- 128 Light Flashing Alarm

Set Light Flashing Alarm to **Enable** or **Disable**.

Set Light Flashing Frequency to **Low Frequency**, **Medium frequency**, **High frequency**, and **Steady On**.

Set **Light Flashing time** as required.

● Regional Settings

Figure 4- 129 Regional Settings

● Schedule Settings

Start Time	End Time	Date	Mode	Operations

Figure 4- 130 Schedule Settings

● New

Click **New** to add new schedule for Start time, End Time, Date, Mode, and Operations.

● Delete All

Click **Delete All** to delete all schedule, if to delete individual one Click  to complete delete option.

4.5.5.2 Sound Detect

- **Rise Audio**

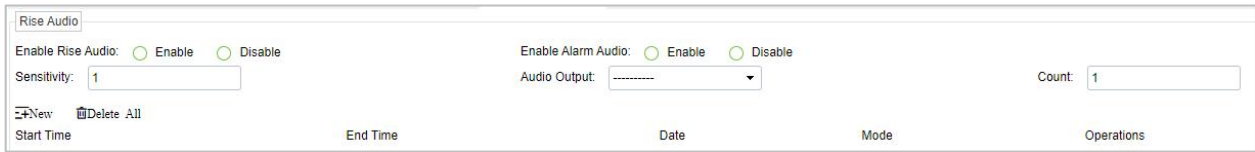

Figure 4- 131 Rise Audio

Set Rise Audio and Alarm Audio as **Enable** or **Disable**.

Set **Sensitivity, Audio Output** and **Count**.

- **New**

Click New to add new schedule for Start time, End Time, Date, Mode, and Operations.

- **Delete All**

Click **Delete All** to delete all schedule, if to delete individual one Click  to complete delete option.

- **Decline Audio**

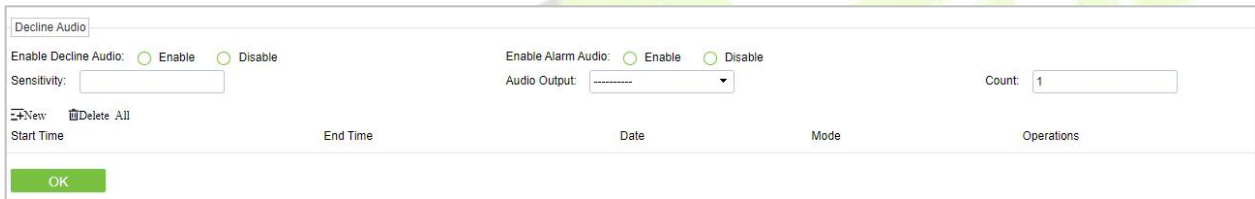

Figure 4- 132 Decline Audio

Set Decline Audio and Alarm Audio as **Enable** or **Disable**.

Set **Sensitivity, Audio Output** and **Count**.

- **New**

Click New to add new schedule for Start time, End Time, Date, Mode, and Operations.

- **Delete All**

Click **Delete All** to delete all schedule, if to delete individual one Click  to complete delete option.

Click **OK** to save and exit.

4.5.6 Vehicle Intelligence (AS1700 Supported)



Figure 4- 133 Vehicle Intelligence

4.5.7 Intelligent Application

It Includes Mixed Detection and Live Alarm.

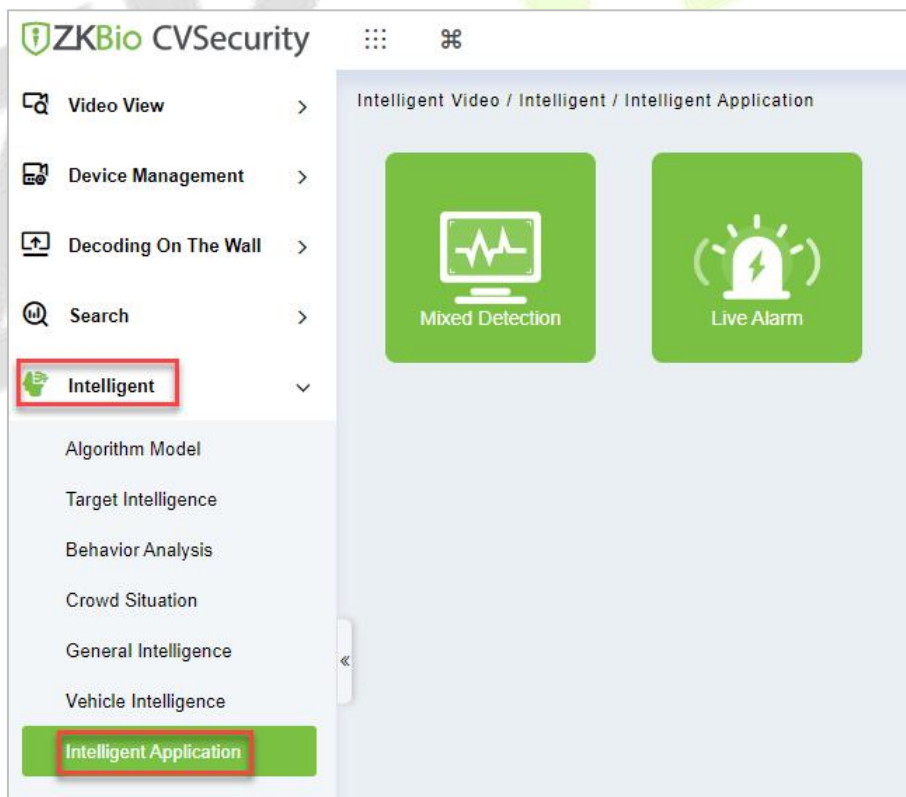

Figure 4- 134 Intelligent Application

- **Mixed Detection**

Click on **Mixed Detection**.

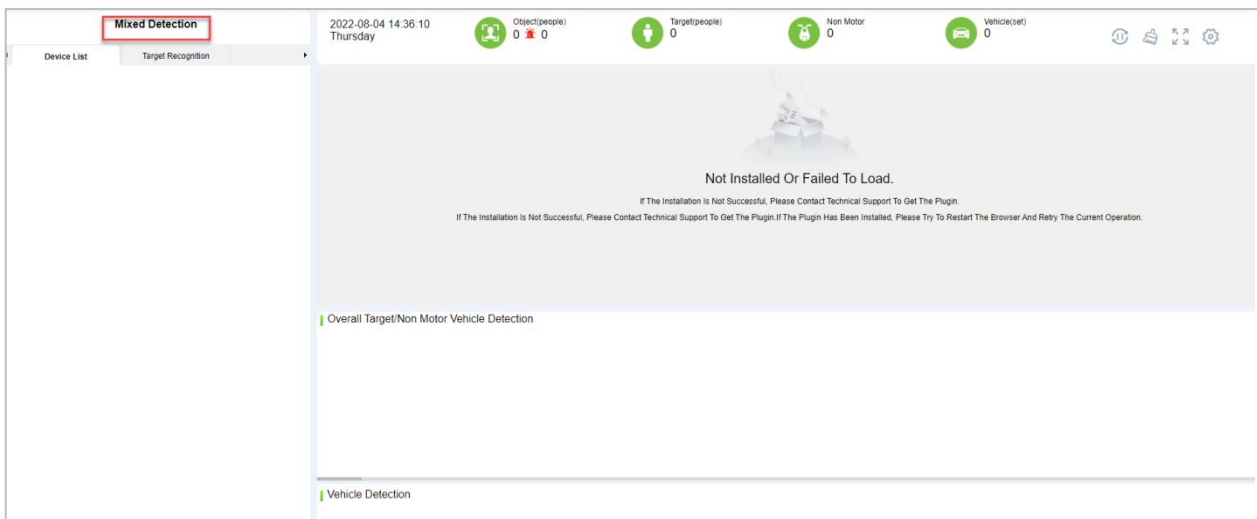

Figure 4- 135 Mixed Detection

- **Device List**

It will displays the list of devices which are connected to the software.

- **Target Recognition**

This function will help you to recognition of the seleted target parking vehicles.

- **Live Alarm**

Click **On Live Alarm**.

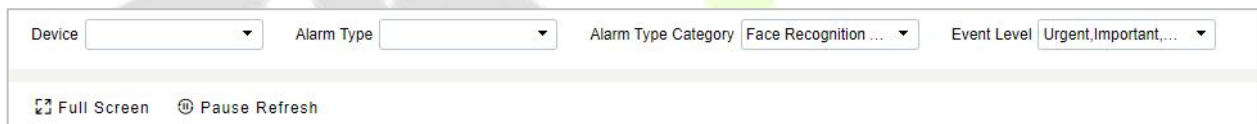

Figure 4- 136 Live Alarm

- **Full Screen**

View the video in the full screen.

- **Pause Alarm.**

This function will help you to pause the alarm.

4.6 Statistics

4.6.1 Face Analysis

Click **Statistics > Face Analysis**, then select **Statistical Period** as Daily, Weekly, Monthly, or Quarterly.

In this module, you can access the data for the type of personnel or person as dd, aa, VIP, or VIP, Forbidden list, pass list, and Stranger to get data to follow the options.

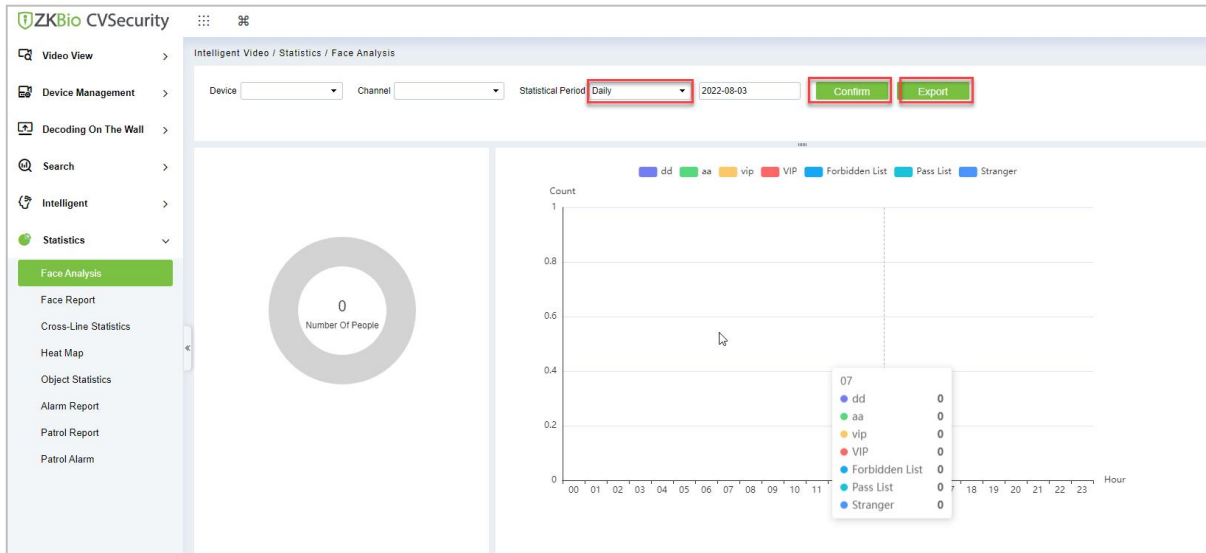

Figure 4- 137 Face Analysis

Parameters	Description
Device	Select the desired device.
Channel	Select the channel.
Statistical Period	Choose your required statistical time period.
Confirm	Click confirm to view a detailed copy of the types of people or persons.

Table 4- 18 Face Analysis

4.6.1.1 Export

Export selected personnel information in the area, you can export Excel, PDF, CSV format.

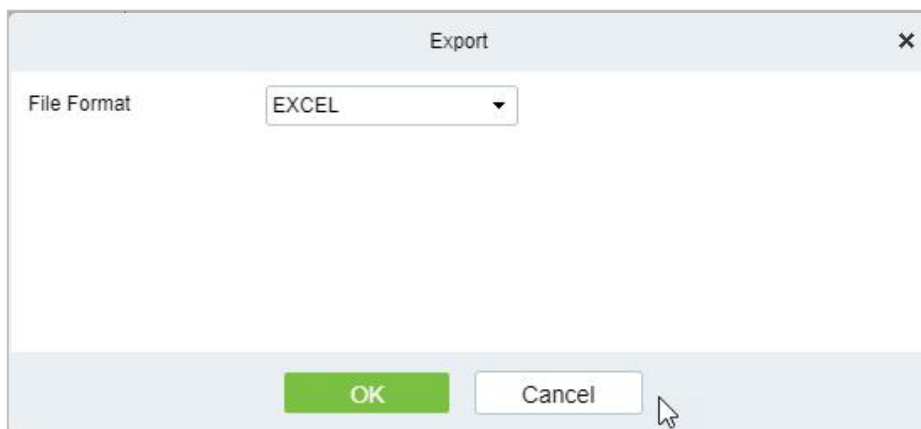

Figure 4- 138 Export

4.6.2 Face Report

Click **Statistics > Face Report**, then select **Statistical Period** as Daily, Weekly, Monthly, or Quarterly.

In this module, you can access the data for the type of personnel or person as Unknown, Juvenile (17 years old and below), Youth (18 to 35 years old), Middle Aged (36 to 59 years old), or Elderly (Over 60 years old) to get data to follow the options.

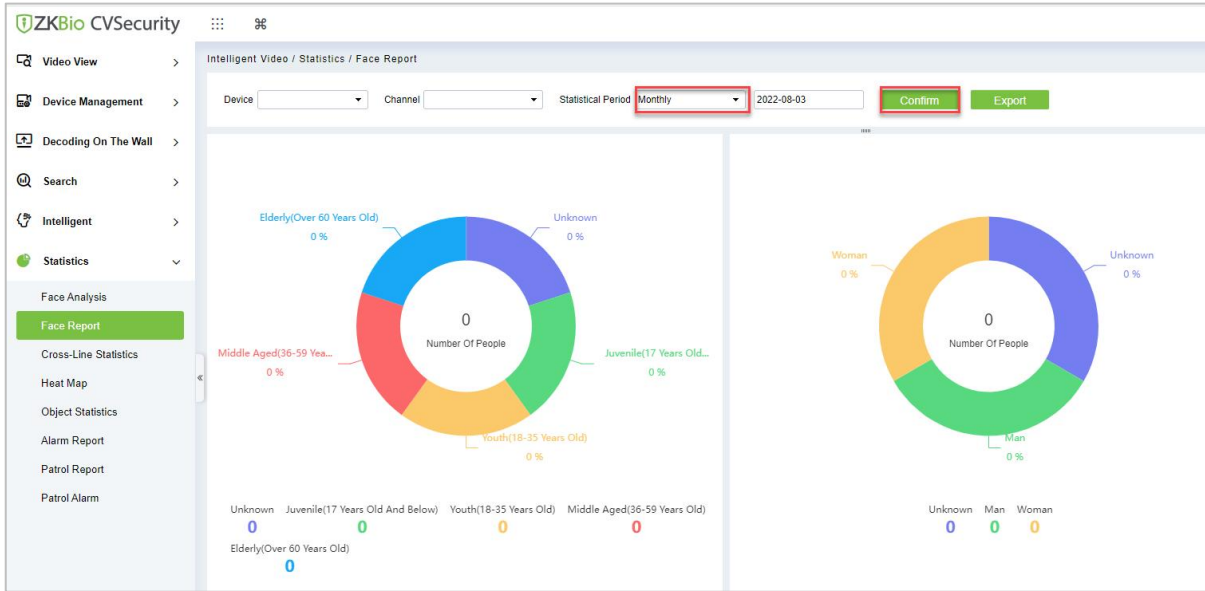

Figure 4- 139 Face Report

Parameters	Description
Device	Select the desired device.
Channel	Select the channel.
Statistical Period	Choose your required statistical time period.
Confirm	Click confirm to view a detailed copy of the types of people or persons.
Start Time	Select the desired time.

Table 4- 19 Face Report

4.6.2.1 Export

Export selected personnel information in the area; you can export Excel, PDF, CSV format.

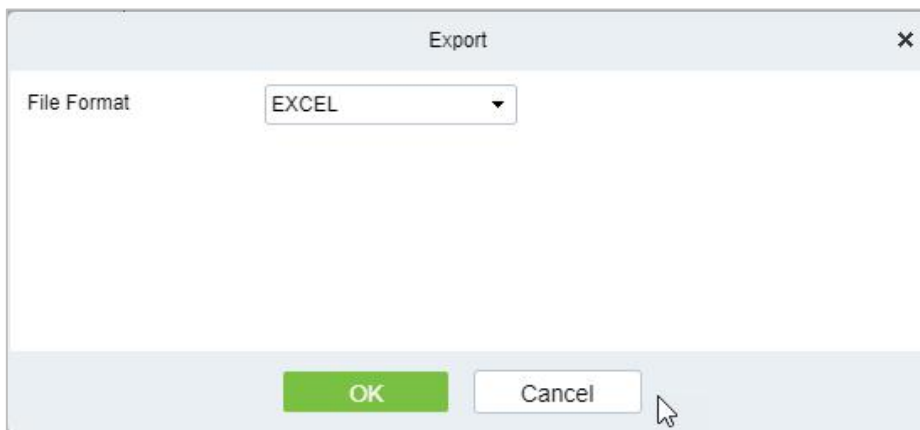

Figure 4- 140 Export

4.6.3 Cross-Line Statistics

Click **Statistics > Cross Line Statistics** then select **Statistical Period** as Daily, Weekly, Monthly, or Quarterly.

In this module, you can access the data for the type of personnel or person as the number of people entering or leaving starting time to get data to follow the options.

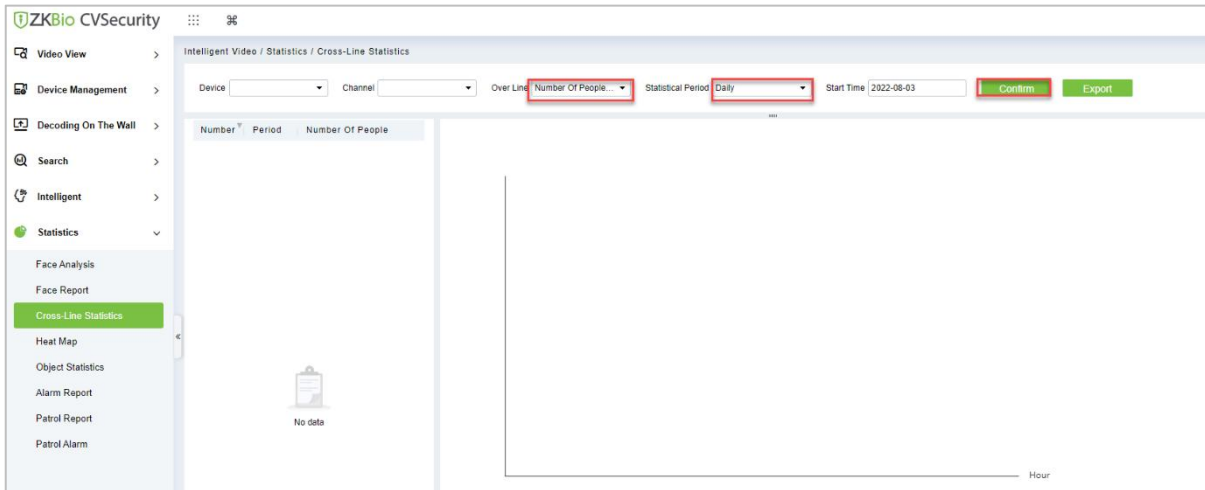

Figure 4- 141 Cross-Line Statistics

Parameters	Description
Device	Select the desired device.
Channel	Select the required channel.
Statistical Period	Choose your required statistical time period.
Confirm	Click confirm to view a detailed copy of the types of people or persons.
Over Line	Select the number of people entering or leaving.
Start Time	Select the desired time.

Table 4- 20 Cross-Line Statistics

4.6.3.1 Export

Export selected personnel information in the area; you can export Excel, PDF, CSV format.

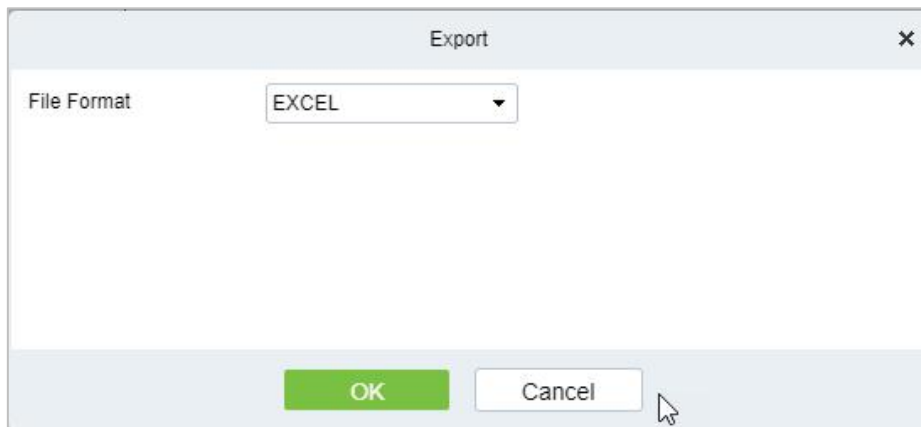

Figure 4- 142 Export

4.6.4 Heat Map

Click **Statistics > Heat Map** then select **Statistical Period** as Daily, Weekly, Monthly, or Quarterly.

In this module, you can access the data for the type of personnel or person as Time Heat Map and image Heat Map to follow the options.

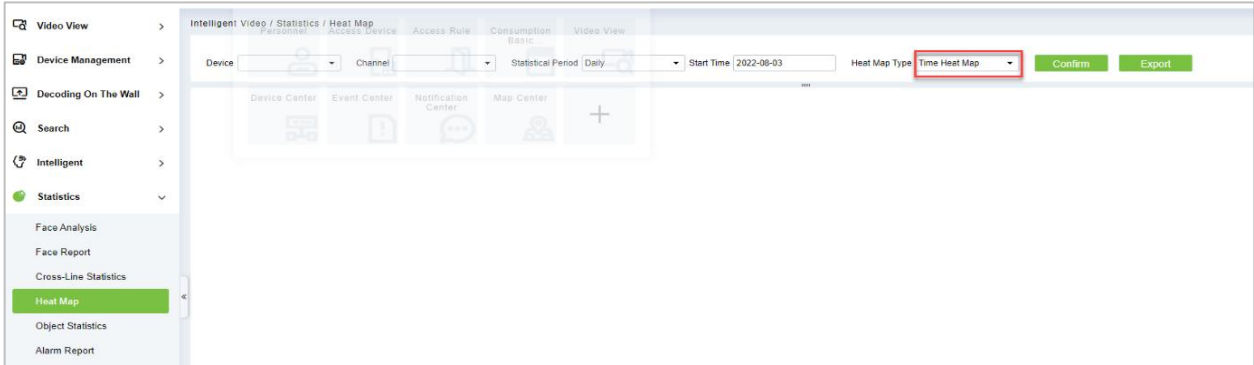

Figure 4- 143 Heat Map

Parameters	Description
Device	Select the desired device.
Channel	Select the required channel.
Statistical Period	Choose your required statistical time period.
Confirm	Click confirm to view a detailed copy of the types of Maps.
Heat Map Type	Select the list of Heat Map types.
Start Time	Select the desired time.

Table 4- 21 Heat Map

4.6.4.1 Export

Export selected personnel information in the area, you can export Excel, PDF, CSV format.

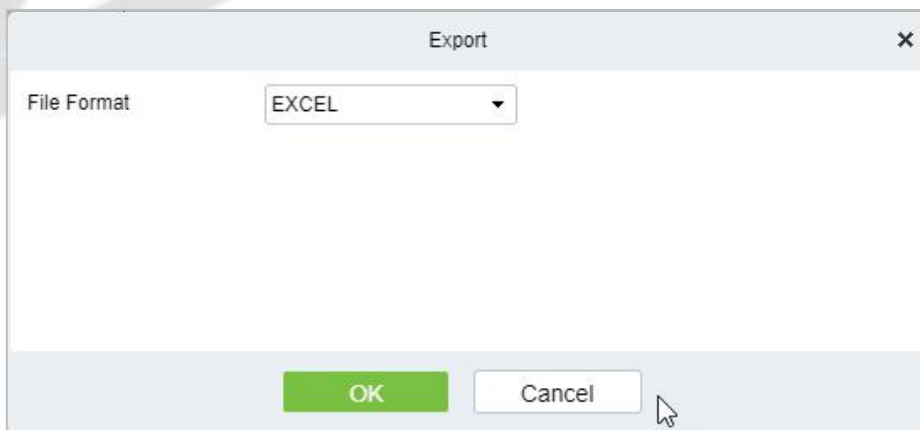

Figure 4- 144 Export

4.6.5 Object Statistics

Click **Statistics > Face Report**, then select **Statistical Period** as Daily, Weekly, Monthly, or Quarterly.

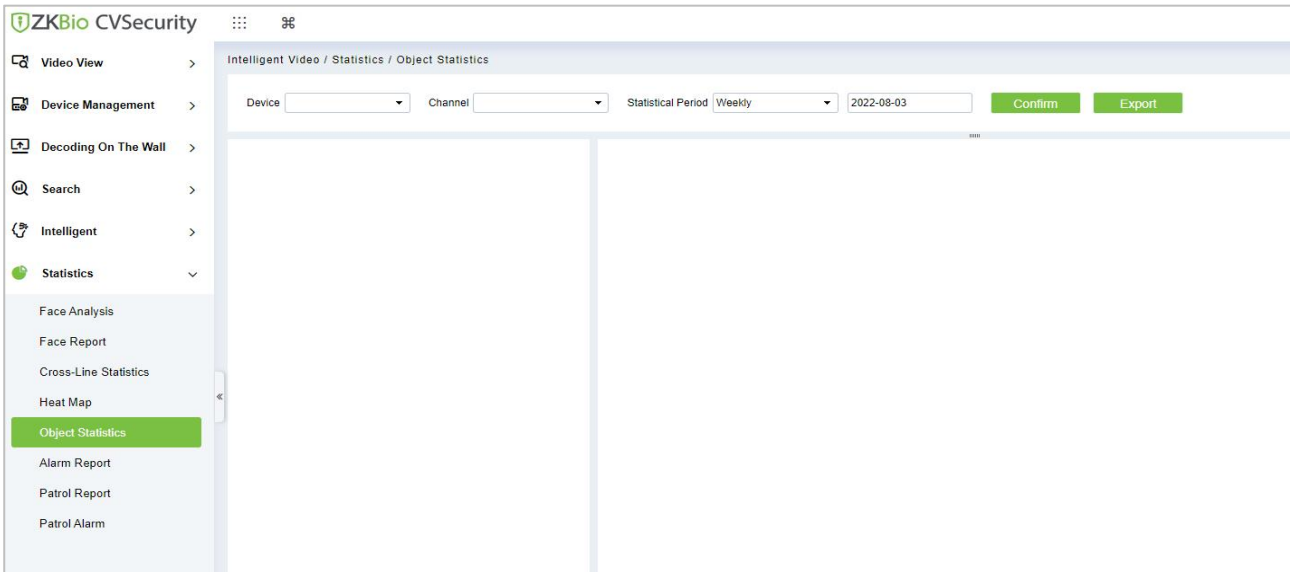

Figure 4- 145 Object Statistics

Parameters	Description
Device	Select the desired device.
Channel	Select the channel.
Statistical Period	Choose your required statistical time period.
Confirm	Click confirm to view a detailed copy of the types of people or persons.

Table 4-22 Object Statistics

4.6.5.1 Export

Export selected personnel information in the area, you can export Excel, PDF, CSV format.

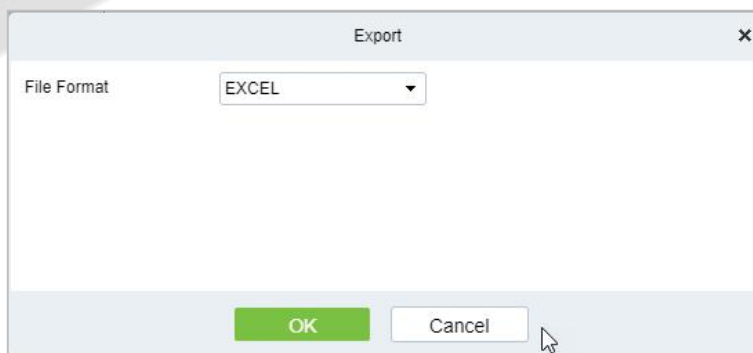

Figure 4- 146 Export

4.6.6 Alarm Report

Click **Statistics > Alarm Report** then select **Alarm Type**.

In this module, you can access the data for the type of personnel or person can select the start time and end time the serial number of the video channel, and different alarm types to filter the report.

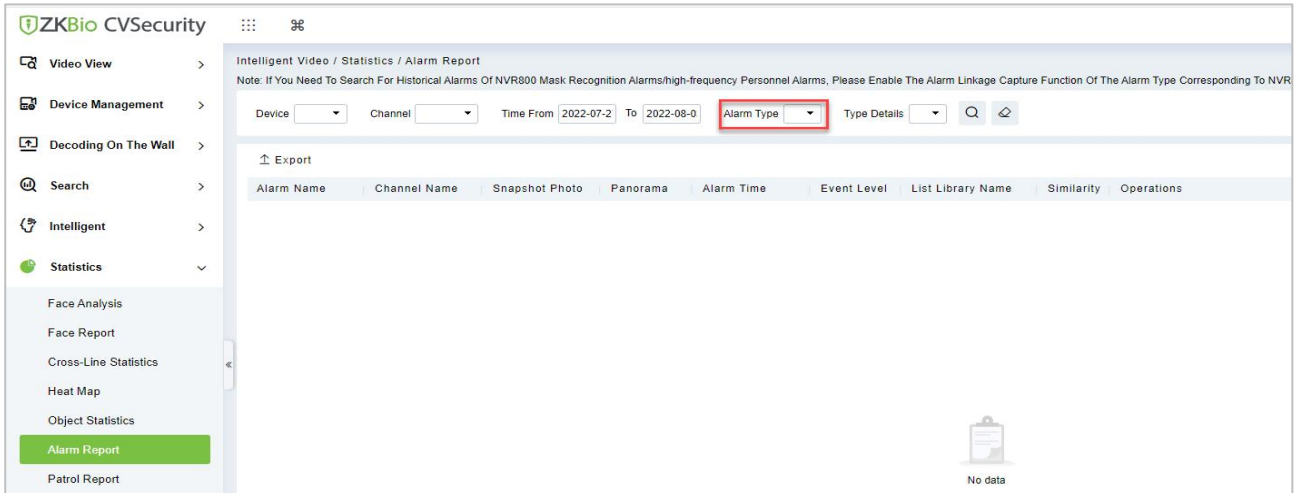

Figure 4- 147 Alarm Report

4.6.6.1 Export

Export selected personnel information in the area; you can export Excel, PDF, or CSV format.

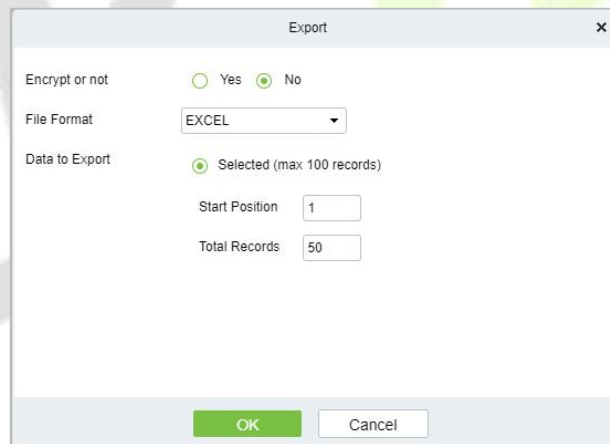

Figure 4- 148 Export

4.6.7 Patrol Report

Click **Statistics > Patrol Report**, then select **Plan Name**.

In this module, you can access the data for the type of personnel or person as dd, aa, vip, or VIP, Forbidden list, pass list, and Stranger to get data to follow the options.

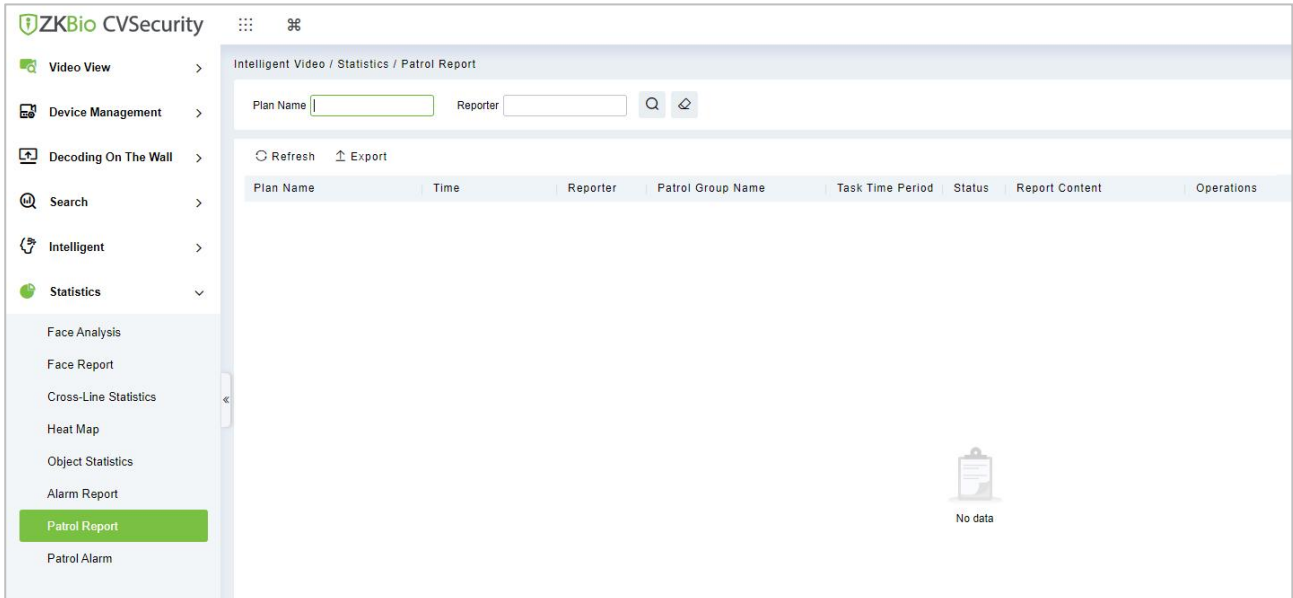

Figure 4- 149 Patrol Report

4.6.7.1 Export

Export selected personnel information in the area; you can export Excel, PDF, CSV format.

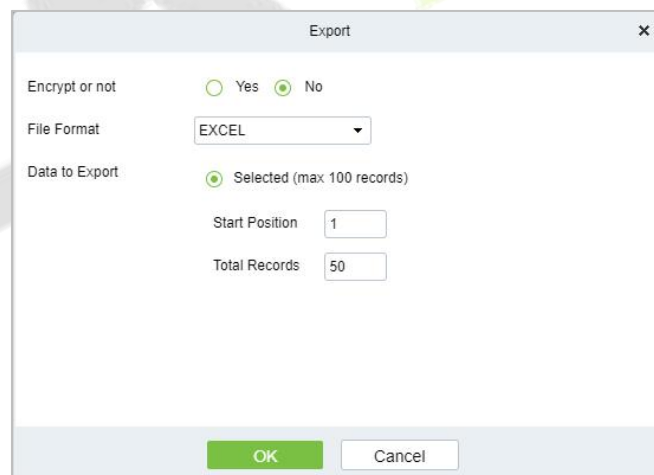

Figure 4- 150 Export

4.6.8 Patrol Alarm

Click **Statistics > Face Analysis**, then select **Statistical Period** as Daily, Weekly, Monthly, or Quarterly.

In this module, you can access the data for the type of personnel or person as dd, aa, vip, or VIP, Forbidden list, pass list, and Stranger to get data to follow the options.

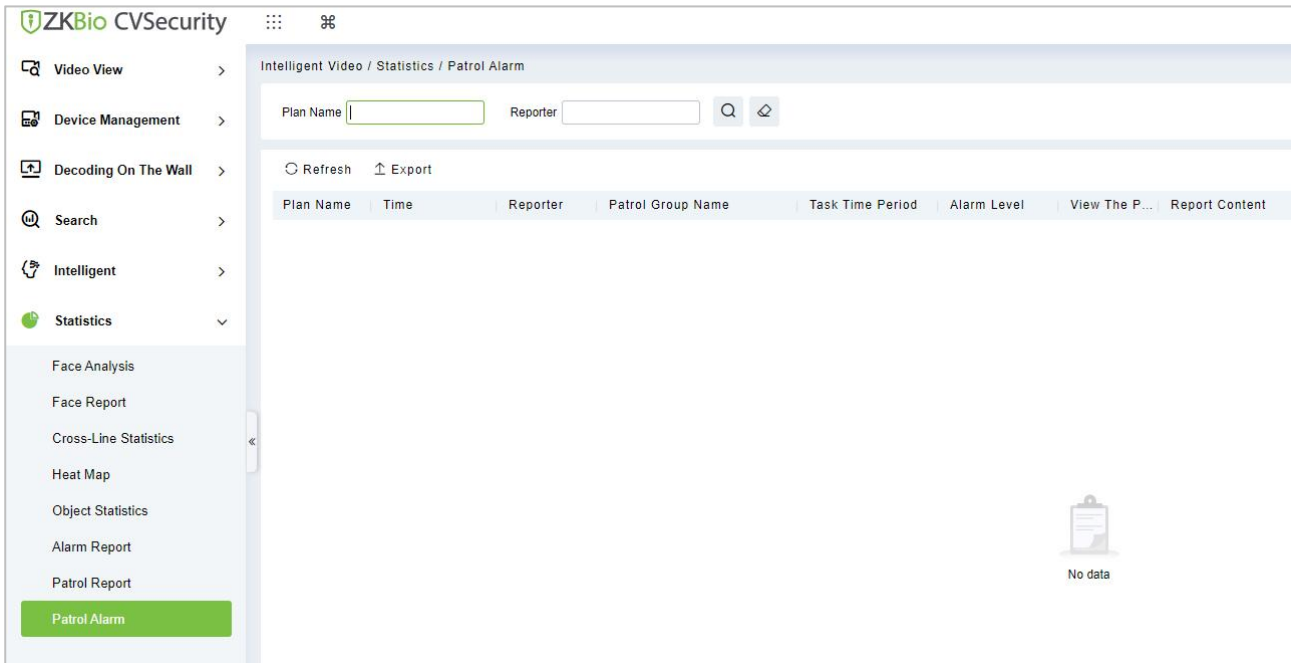

Figure 4- 151 Patrol Alarm

4.6.8.1 Export

Export selected personnel information in the area; you can export Excel, PDF, CSV format.

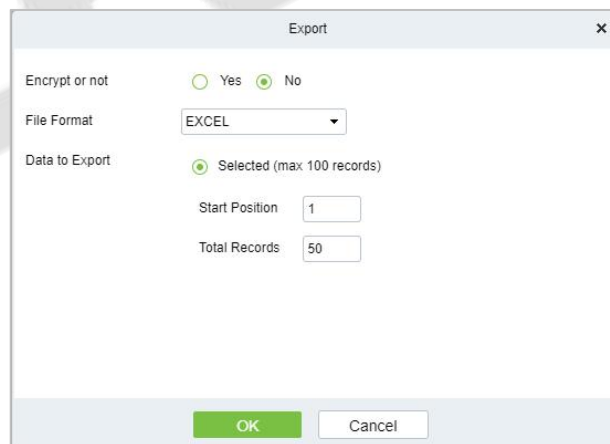

Figure 4- 152 Export

4.7 Video Patrol

Click > **Video Patrol** > **Patrol Group**

On the preset path, you can check the punch-in by a real-time preview of the camera remotely to achieve the same patrol task as the traditional punch-in effect.

4.7.1 Patrol Group

Create a patrol group to add patrol personnel.

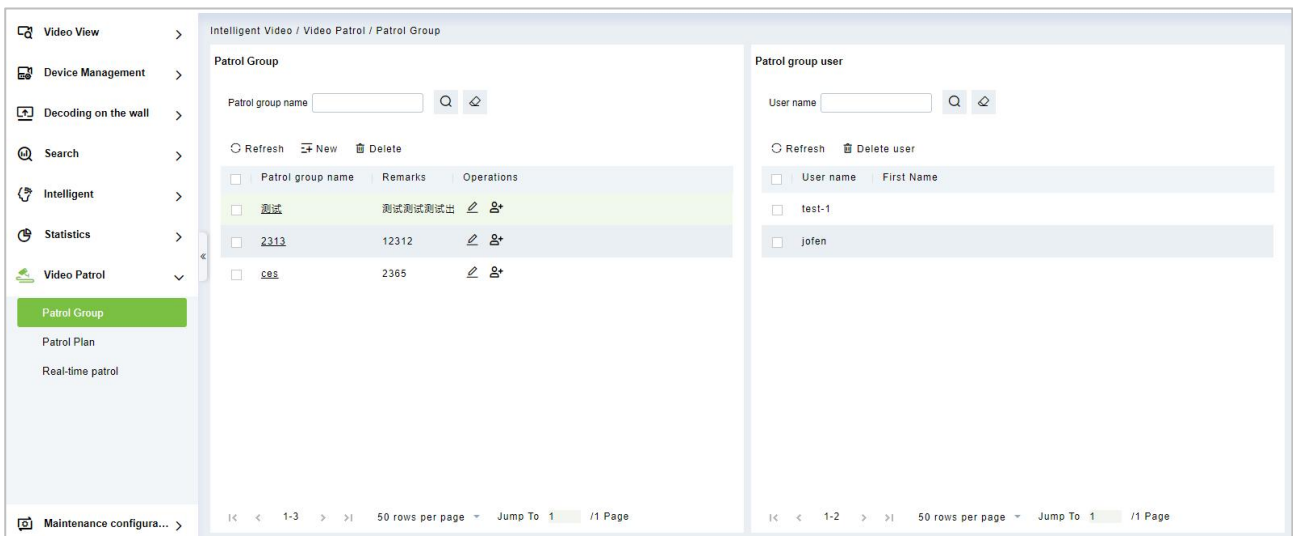

Figure 4- 153 Patrol Group

4.7.1.1 New

Click Video Patrol> patrol group> New to enter the new editing interface:

Figure 4- 154 New Patrol Group

Patrol Group Name: Enter the name of the patrol group for easy searching and management non-repeatable.

Remarks: Text notes of the patrol group.

4.7.1.2 Delete

Select the patrol group name and click this button to delete it.

4.7.1.3 Add Patrol Group User

In the patrol group list, click Add User to enter and select to add group members.

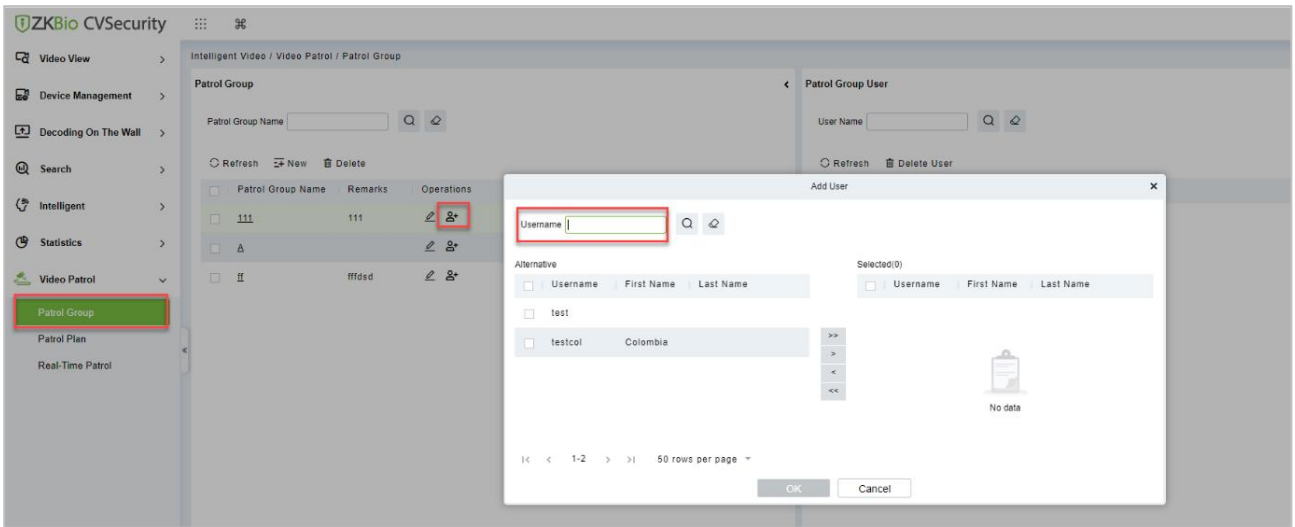

Figure 4- 155 Add Patrol Group User

Select the required patrol users and click the OK button to complete the addition. The added users will be displayed in the group member list on the right.

Note: Patrol users are groups of system users. For adding users to the system, please refer to Adding Users.

4.7.1.4 Delete User

Select the Username and click this button to delete it.

4.7.2 Patrol Plan

Set a patrol plan for the patrol team.

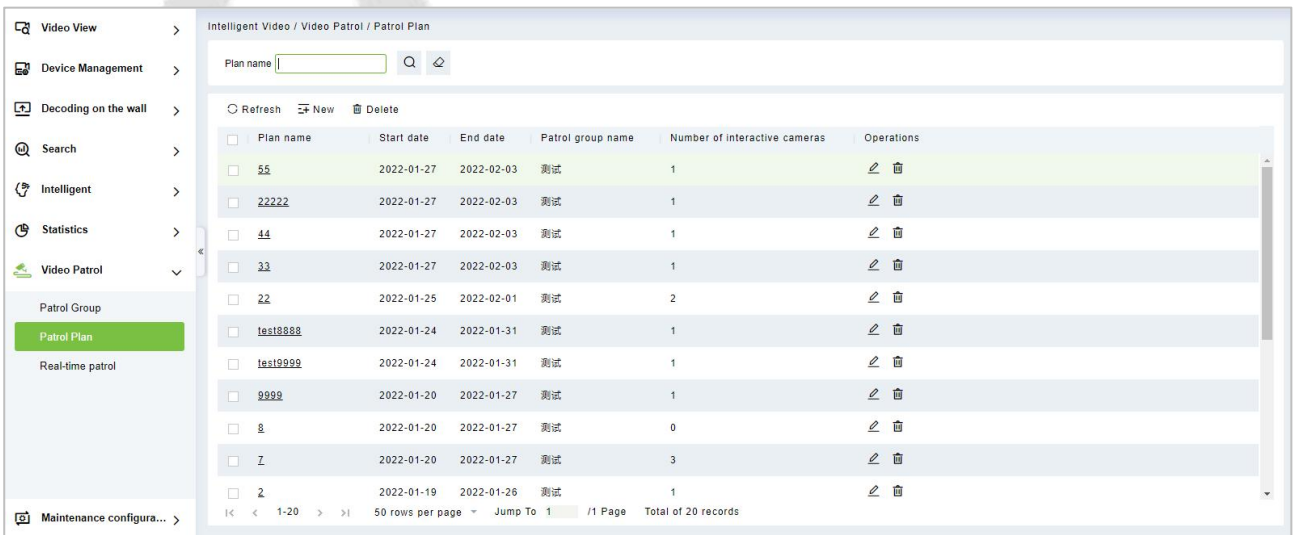

Figure 4- 156 Patrol Plan

4.7.2.1 New

Click **Video Patrol > patrol plan > New** to enter the new editing interface:

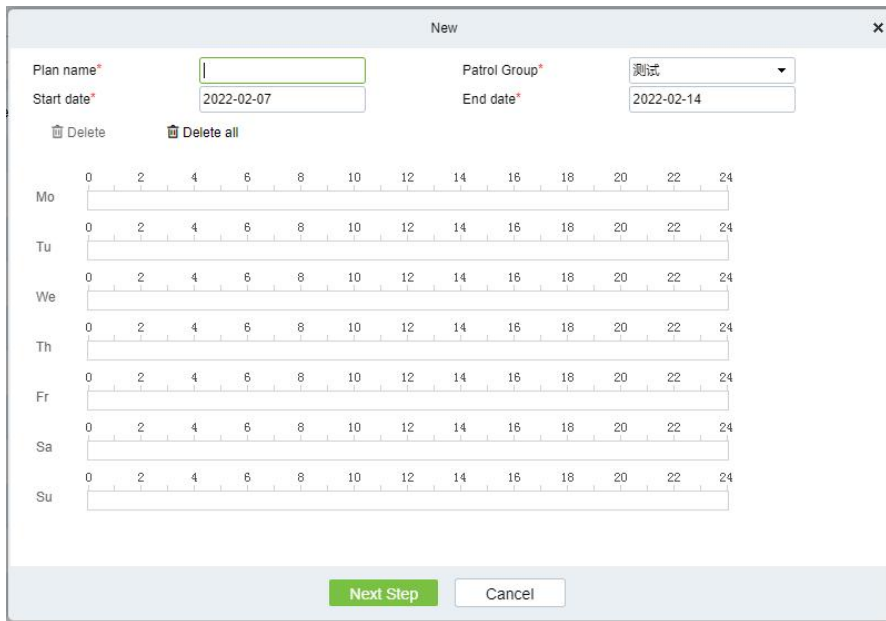

Figure 4- 157 New

The fields are described as follows:

Parameters	Instructions
Plan Name	Give the plan a name, make it easy to view and find, not repeatable
Patrol Group	Optional created patrol group.
Start Date	Set the start date of the patrol. The start date must not be less than the end date.
End Date	Set the end date of the patrol. The start date must not be less than the end date.
Patrol Time	Drag the time bar to select the time period that needs to be patrolled. Multiple copies are supported.

Table 4- 22 New

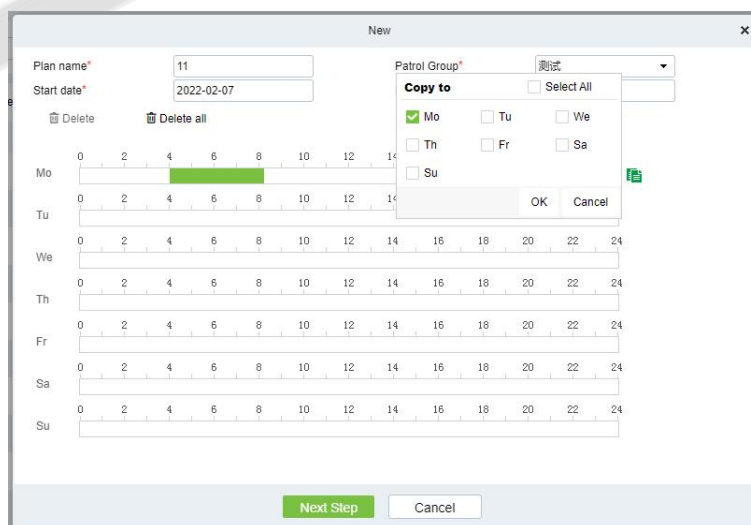

Figure 4- 158 New

After editing this page, click Next to enter the camera selection interface:

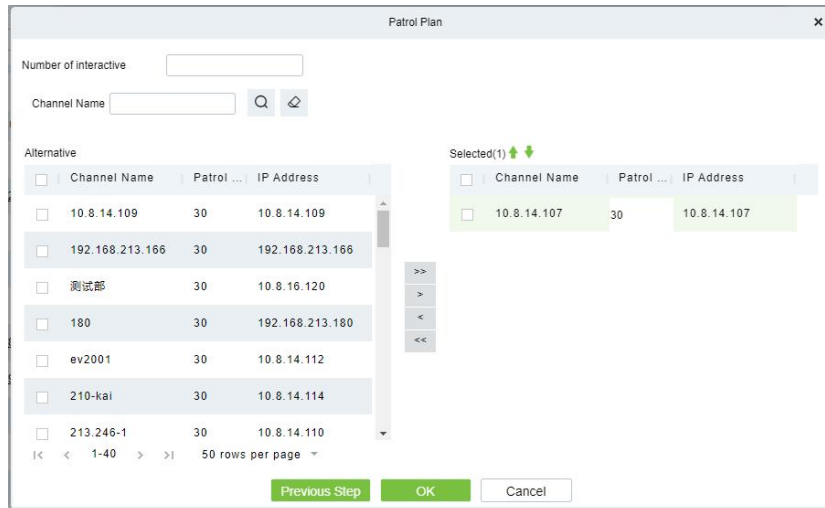

Figure 4- 159 New

Number of interactive Cameras: Set the number of cameras that need to be chick-in, (like "5" means that Chick-in must be completed on 5 cameras during this patrol plan, this number must be less than or equal to the number of cameras you have chosen)

Channel Name: Search the channel

Device List: Select the equipment on the map that needs to be patrolled. The device list shows only the devices that have been added to the current map, if you want to add a device, go to Device Add

Note: You can set the length of time you need to watch each camera by clicking on the cruise time, which is 30 seconds by default

4.7.2.2 Delete

Select the Patrol Plan to be deleted and click the Delete button

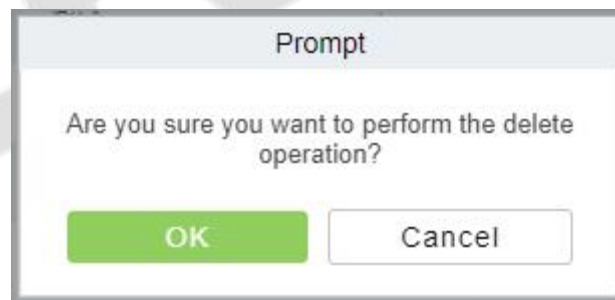

Figure 4- 160 Prompt

Note: Ongoing or pause plans cannot be deleted, please complete the plan first.

4.7.3 Real-Time Patrol

Online patrols are only available if the patrolman is logged into the system.

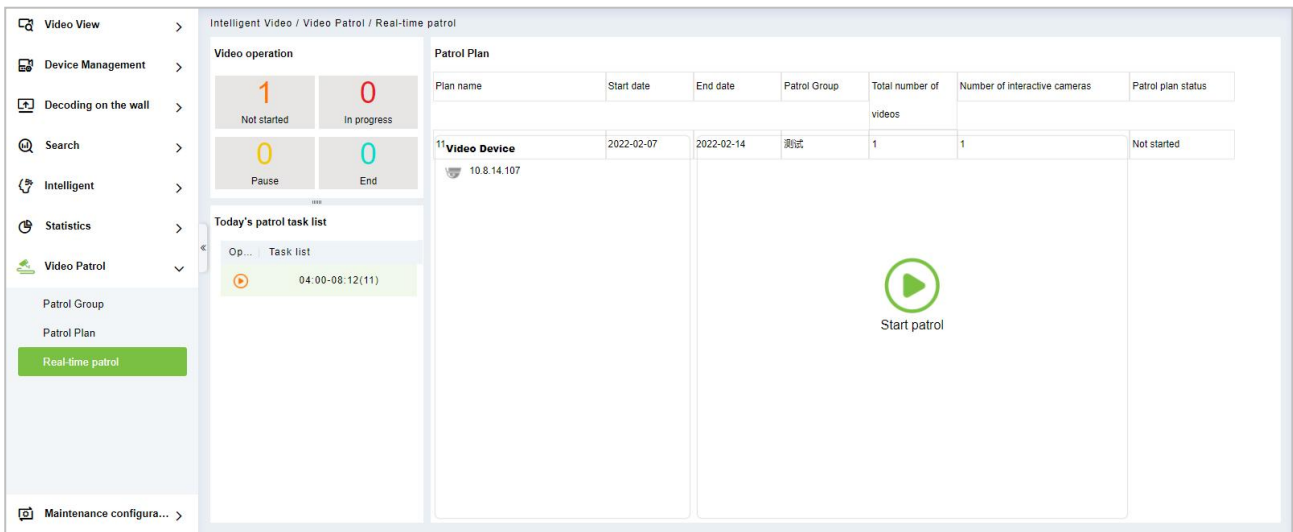

Figure 4- 161 Real-Time Monitoring

Video Operation:

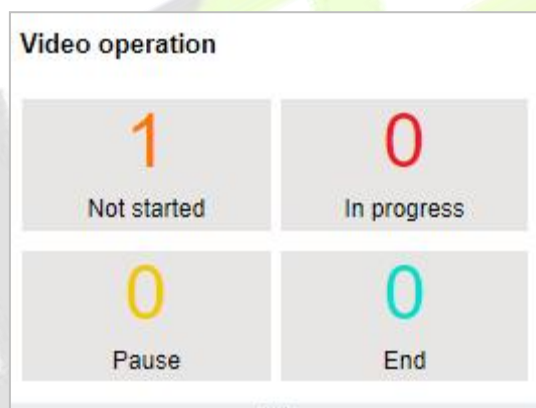

Figure 4- 162 Video Operation

View different states of the Patrol plan

Today's Patrol Task List:

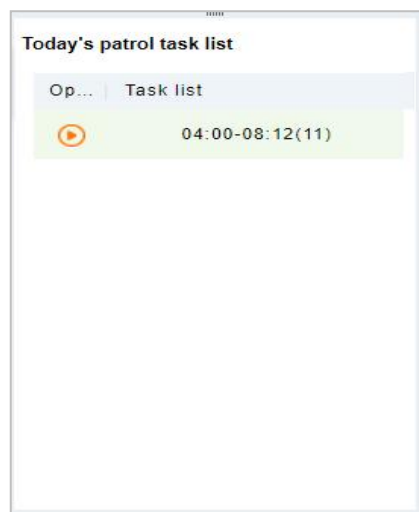

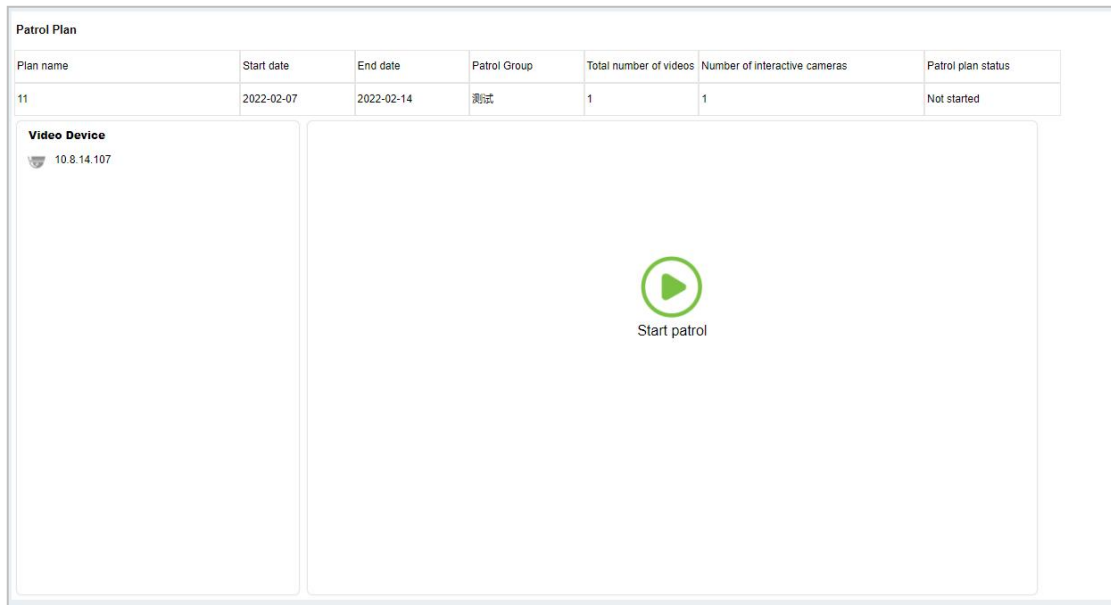

Figure 4- 163 Today's Patrol Task List

Displaying the patrol plan, click  to patrol

Patrol Plan:



Plan name	Start date	End date	Patrol Group	Total number of videos	Number of interactive cameras	Patrol plan status
11	2022-02-07	2022-02-14	测试	1	1	Not started

Video Device
10.8.14.107

Start patrol

Figure 4- 164 Patrol Plan

Show patrol plan, video device, and patrol window in this area.

Patrol Window:

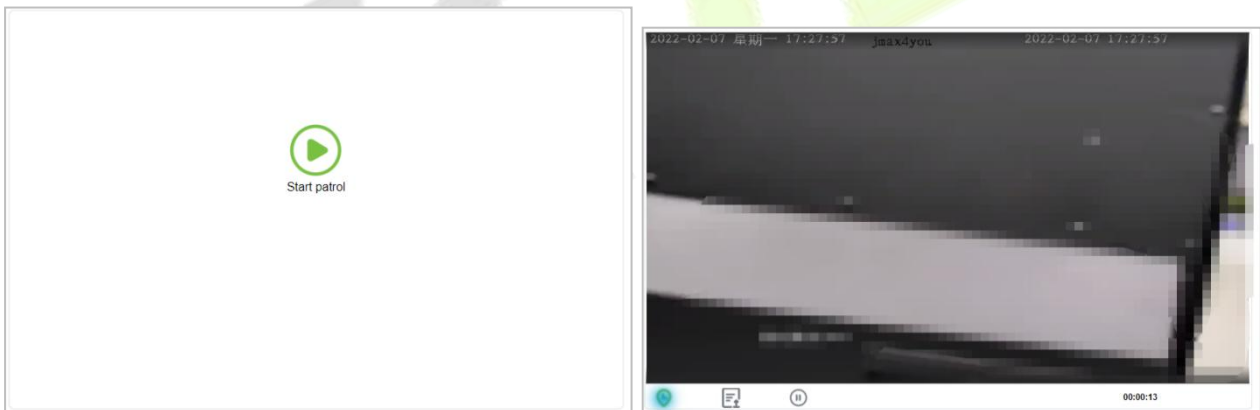

Start patrol

2022-02-07 星期一 17:27:57 jmax4you 2022-02-07 17:27:57

00:00:13

Figure 4- 165 Patrol Window

At cruising time patrolman should Check-in if required.

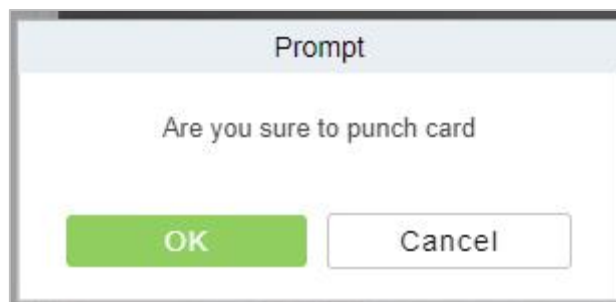

Prompt

Are you sure to punch card

OK Cancel

Figure 4- 166

Figure 4-156 Patrol Window

The check-in button blinks continuously when the check-in point is required.

Click  to report the alarm.

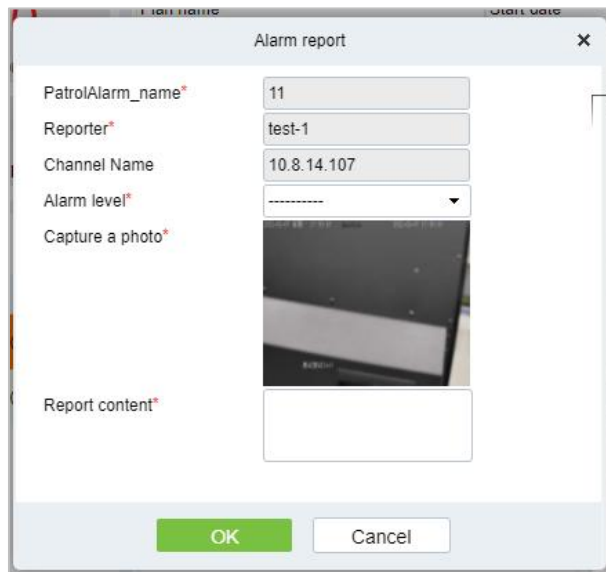

The 'Alarm report' dialog box contains the following fields and controls:

- PatrolAlarm_name*: 11
- Reporter*: test-1
- Channel Name: 10.8.14.107
- Alarm level*: -----
- Capture a photo*: 
- Report content*:
- Buttons: OK, Cancel

Figure 4- 167 Alarm Report

Click  to Pause the plan

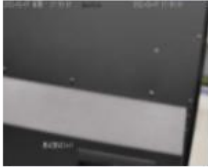
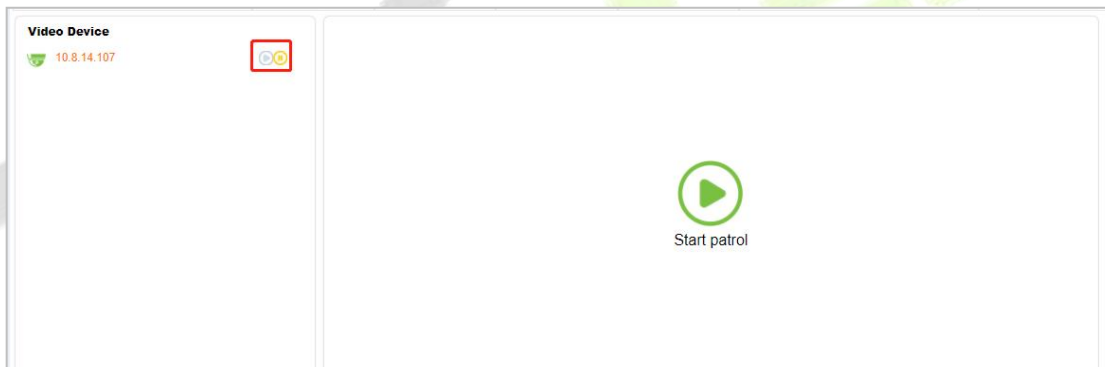

The 'Video Device' interface shows a video feed area on the left with a red box around the camera icon and a 'Start patrol' button with a play icon on the right.

Figure 4- 168 Video Device

After that, it automatically switches to the next camera.

When all the cameras have been cruised, a Report Window will pop up.



The 'Report patrol report' dialog box contains the following fields and controls:

- PatrolAlarm_name*: 11
- Reporter*: test-1
- Report content*:
- Buttons: OK, Close

Figure 4- 169 Report Patrol Report

Submit the report to finish the patrol plan.

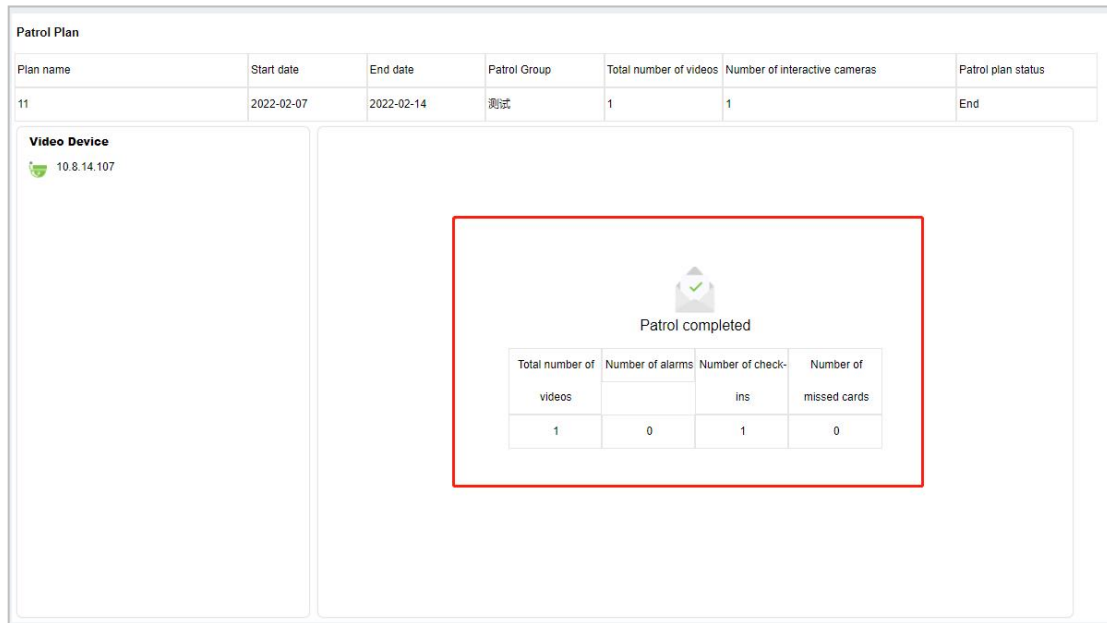

Figure 4- 170 Patrol Completed

4.8 Maintenance Configuration (AS1700 Supported)

4.8.1 Developer Log

Click **Intelligent Video > Maintenance Configuration**, then select **One-Click Collection**.

Users can download all system logs and system information to get Click on the **One-Click Collection** option.



Figure 4- 171 One-Click Collection

4.8.2 Client Request Log

4.8.2.1 Clear All Data

Click **Clear All Data** to pop up the prompt and click **OK** to clear all Data Operations.

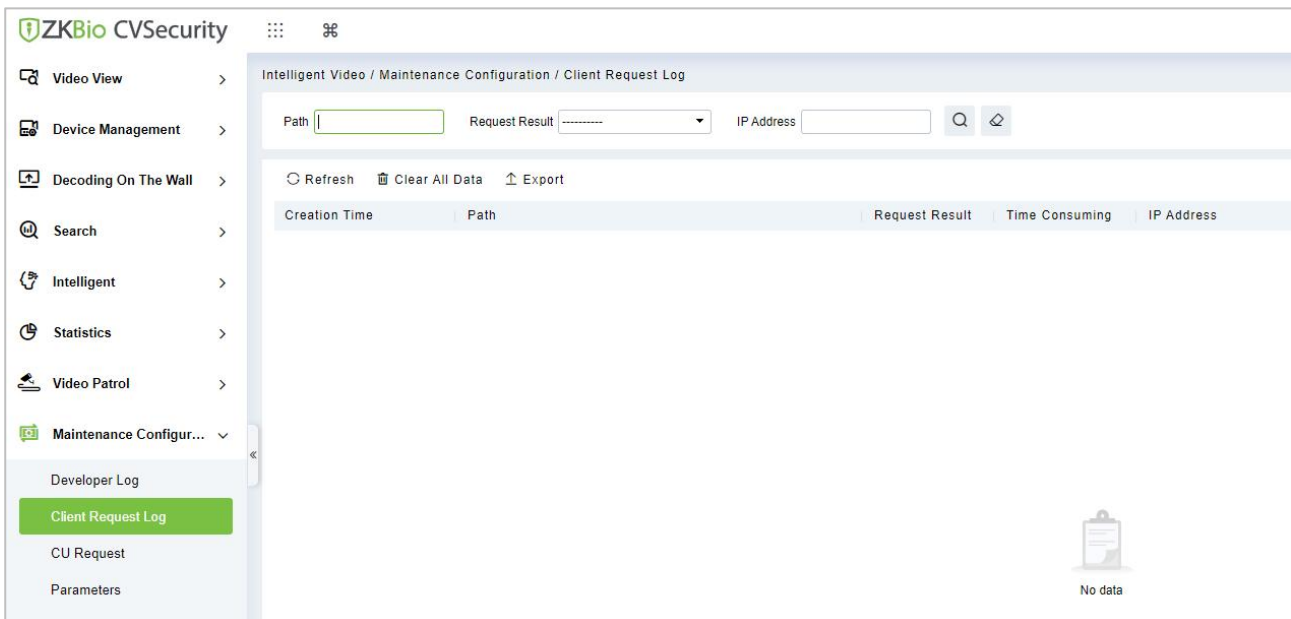

Figure 4- 172 Client Request Log

4.8.2.2 Export

Export selected personnel information in the area; you can export Excel, PDF, CSV format.

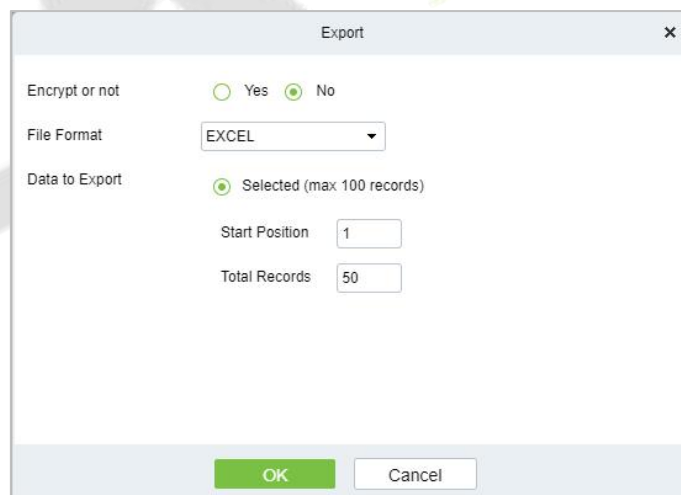

Figure 4- 173 Export

4.8.3 CU Request

4.8.3.1 Clear All Data

Click **Intelligent Video > Clear All Data** to pop up the prompt and click **OK** to clear all Data Operations.

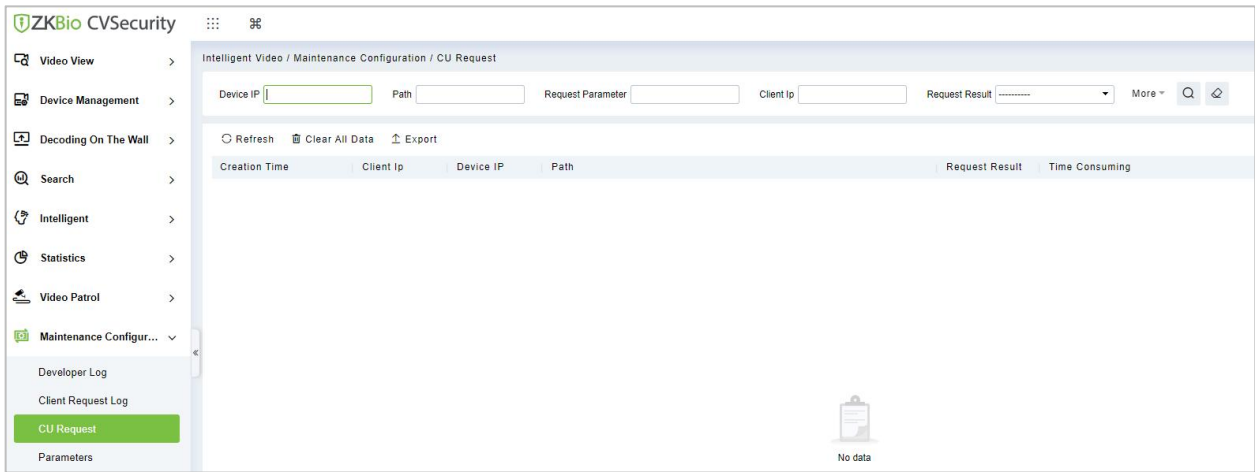

Figure 4- 174 Clear all Data

4.8.3.2 Export

Export selected personnel information in the area; you can export Excel, PDF, CSV format.

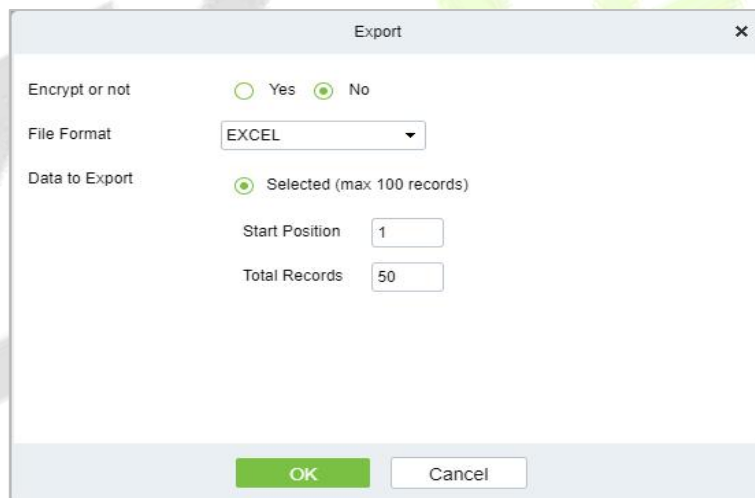

Figure 4- 175 Export

4.8.4 Parameters

Click **Intelligent Video > Parameters**, then Set up all the **settings**, then Click **OK**.

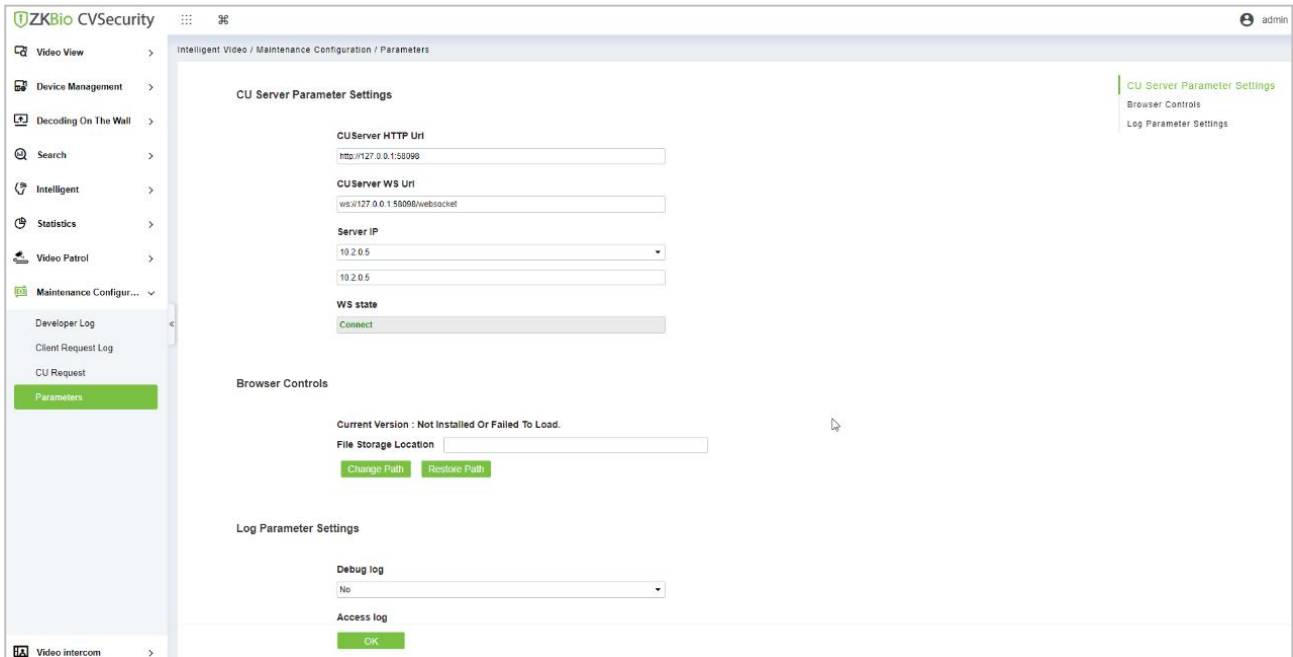

Figure 4- 176 Parameters

Parameters	Instructions
CU Server Parameter Settings	Set Up CU server HTTP Url and WS Url and enter Server IP address then can view WS state.
Browser Controls	Set up the File Storage location and change and restore the path
Log Parameter Settings	Set Up the debug log and Access log, and select Yes/No.

Table 4- 23 Parameters

4.9 Video Intercom

4.9.1 Video Intercom equipment

It mainly introduces the visual intercom application of the platform and the **Access Control** machine, mainly used for offices, and the front desk can realize the opening of the door and other applications through the visual intercom.

Operation Guide:

Step1: Add access control devices. Go to **Access Control** Module, Search, and add devices.

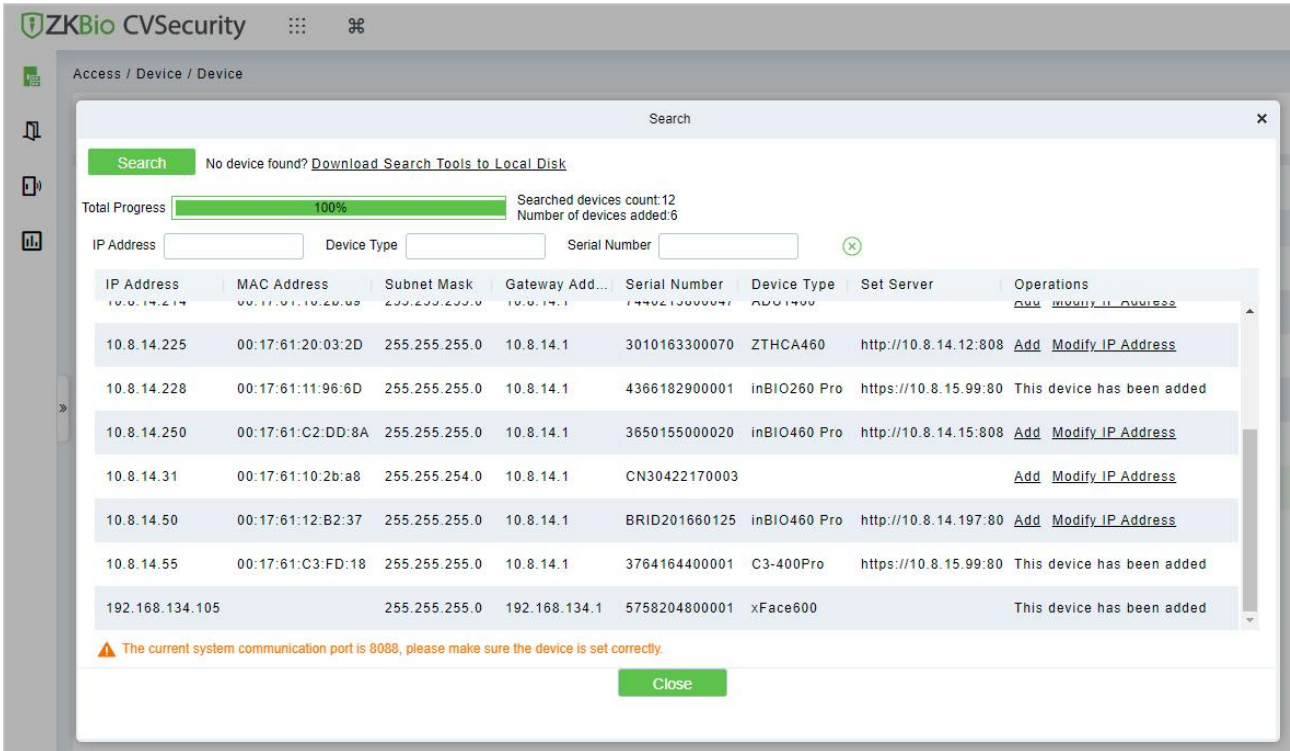

Figure 4- 177 Add AC Devices

Step 2: After adding, the device will automatically add to **Video Management**-Video Intercom, and you can do a Preview.

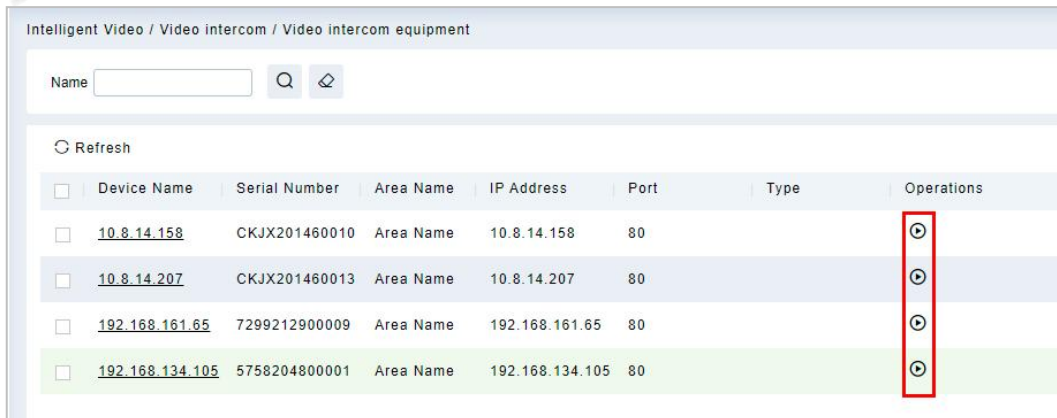

Figure 4- 178 Video Intercom Devices

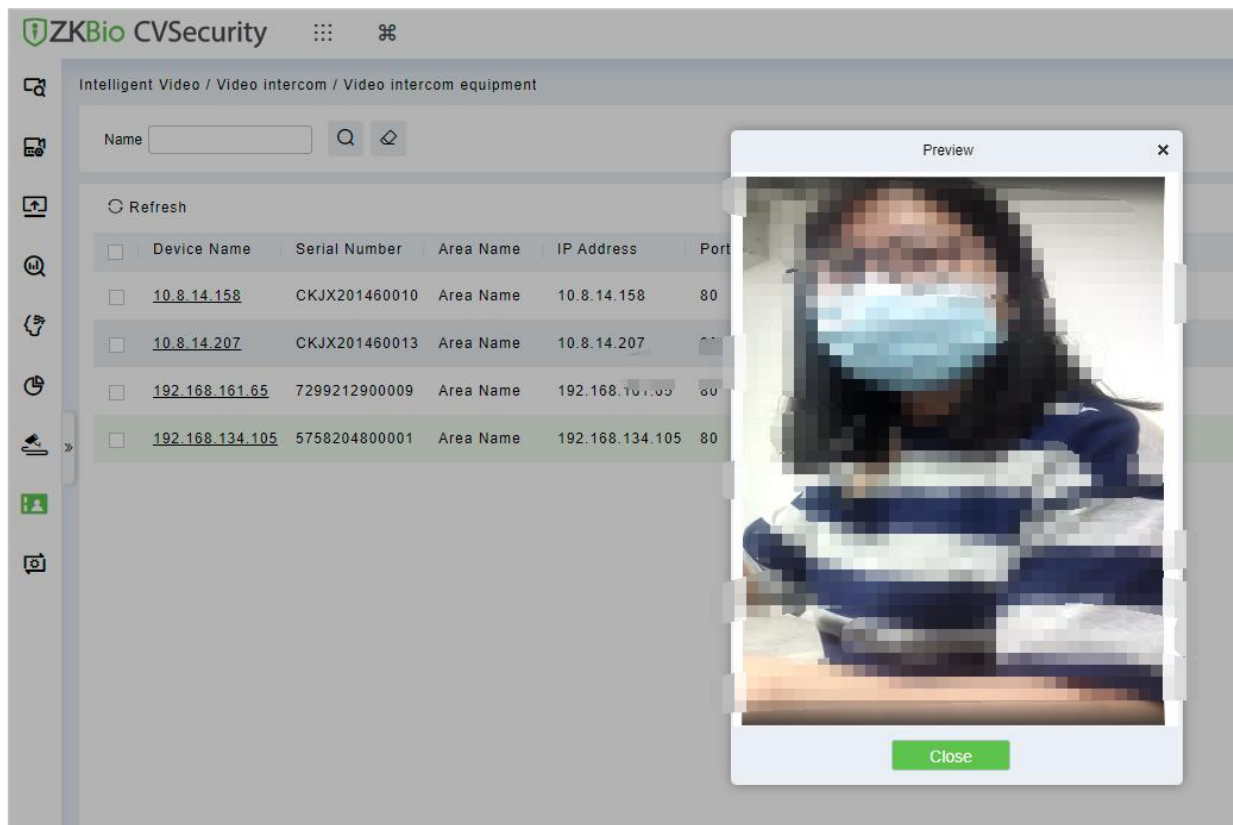

Figure 4- 179 Video Preview

Step 3: When someone presses the doorbell button on the device, the platform automatically pops up the call interface. You can click  to answer.



Figure 4- 180 Incoming Call

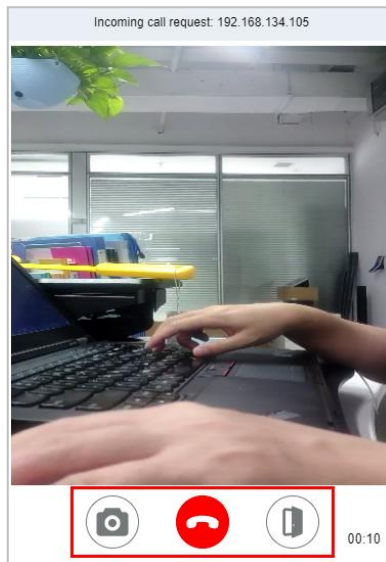



Figure 4- 181 Answering

 : Capture a screenshot and will pop up the notification below.

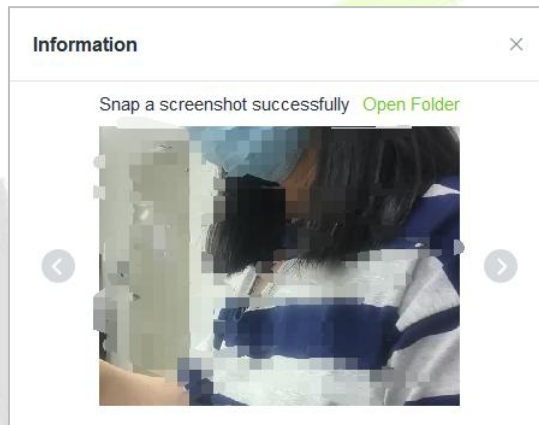



Figure 4- 182 Snapshot

 : End the call

 : Open the door.

4.9.2 Call records

Go to Video Intercom-Call records, you can view the report and see a record of all the answers, you can export the reports via excel/pdf/cvs/txt.

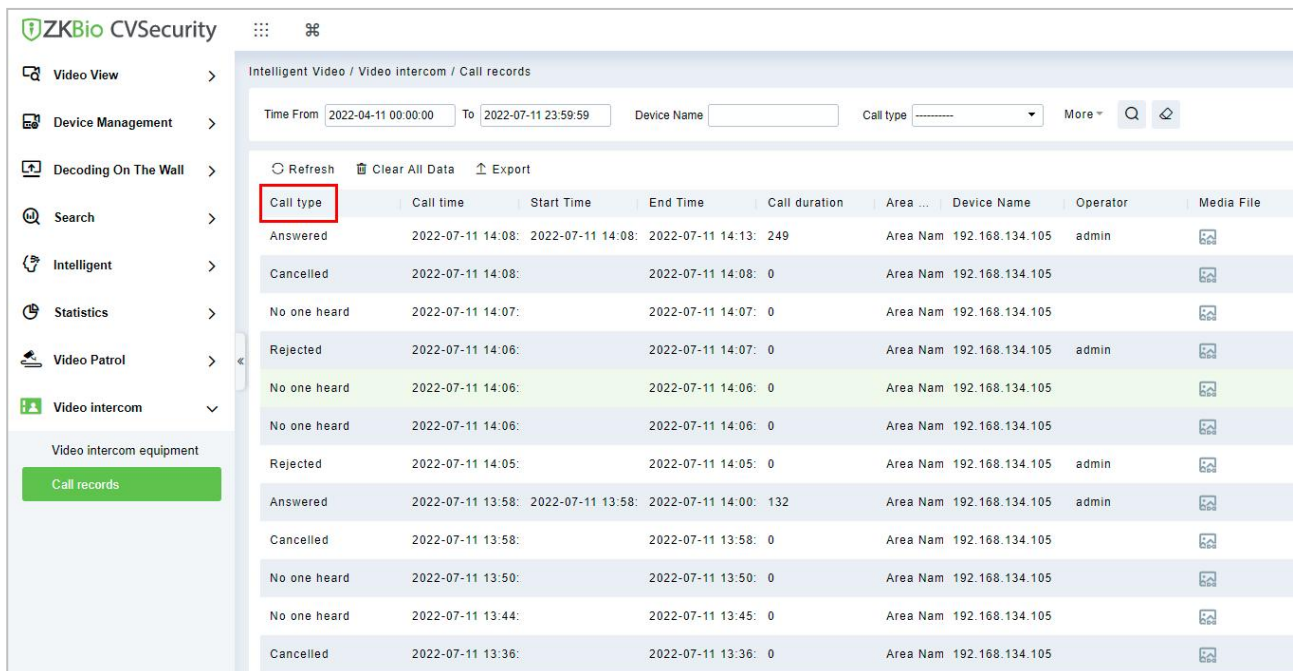

Call type	Call time	Start Time	End Time	Call duration	Area ...	Device Name	Operator	Media File
Answered	2022-07-11 14:08:	2022-07-11 14:08:	2022-07-11 14:13:	249	Area Nam	192.168.134.105	admin	
Cancelled	2022-07-11 14:08:	2022-07-11 14:08:	2022-07-11 14:08:	0	Area Nam	192.168.134.105		
No one heard	2022-07-11 14:07:	2022-07-11 14:07:	2022-07-11 14:07:	0	Area Nam	192.168.134.105		
Rejected	2022-07-11 14:06:	2022-07-11 14:06:	2022-07-11 14:07:	0	Area Nam	192.168.134.105	admin	
No one heard	2022-07-11 14:06:	2022-07-11 14:06:	2022-07-11 14:06:	0	Area Nam	192.168.134.105		
No one heard	2022-07-11 14:06:	2022-07-11 14:06:	2022-07-11 14:06:	0	Area Nam	192.168.134.105		
Rejected	2022-07-11 14:05:	2022-07-11 14:05:	2022-07-11 14:05:	0	Area Nam	192.168.134.105	admin	
Answered	2022-07-11 13:58:	2022-07-11 13:58:	2022-07-11 14:00:	132	Area Nam	192.168.134.105	admin	
Cancelled	2022-07-11 13:58:	2022-07-11 13:58:	2022-07-11 13:58:	0	Area Nam	192.168.134.105		
No one heard	2022-07-11 13:50:	2022-07-11 13:50:	2022-07-11 13:50:	0	Area Nam	192.168.134.105		
No one heard	2022-07-11 13:44:	2022-07-11 13:44:	2022-07-11 13:45:	0	Area Nam	192.168.134.105		
Cancelled	2022-07-11 13:36:	2022-07-11 13:36:	2022-07-11 13:36:	0	Area Nam	192.168.134.105		

Figure 4- 183 Call Records

Note: How to set the device?

Please Go to **Device > System > Video Intercom Parameters**, to set the intercom server address.

5 Intelligent Analysis

Scene Description:

The **Intelligent Analysis** module focuses on intelligent analysis business, and realizes design concepts such as enabling application, data analysis, process management and access control linkage based on scene application and data display through the perception and analysis ability of intelligent NVR or Intelligent cameras, providing intelligent and convenient intelligent analysis solutions for small and micro customers.

The whole module includes three menus: scenario application, business configuration and report. Scene application includes target search, People Control, Tailing Detection, Perimeter Protection, attendance checking, and people counting functions.

5.1 Scene Application

5.1.1 Target Search

Operation scenario:

Taking personnel name, ID and certificate number as retrieval conditions or uploading personnel pictures, the intelligent analysis event records of personnel within a certain time range are searched and the corresponding trend report is generated.

5.1.1.1 Personnel Information Query Intelligent Analysis Events

Operating Steps:

Step 1: In the **Intelligent Scenario** module, select **Scenario Application > Target Search**.

Step 2: In the target search interface, fill in the time period and data source, enter the name or job number of the person in the search box and click **Retrieval** to find the target.

The screenshot displays the 'Target Search' interface. At the top, there's a breadcrumb 'Intelligent Scene / Scene Application / Target Search'. The main title is 'Target Search'. Below it, there are several input fields and controls: 'Time Frame' with a date range from 2021-12-19 15:15:07 to 2021-12-20 15:15:07; 'Data Modules' with a dropdown menu; 'Thresholds' with a slider set to 50; and several filter dropdowns for 'Gender', 'Glasses', 'Mask', 'Upper Color', and 'Lower Color', all currently set to 'Unlimited'. A search box contains the placeholder text 'Please enter your name or job number' and a green 'Retrieval' button. Below the search area is a 'Trend Report' section with a table header: 'Create Time', 'Report Name', 'Report Describe', 'Creator', 'Operate', and 'More...'. The table body is empty, with a 'No data' message and a trash icon at the bottom.

Figure 5- 1 Target Search

Step 3: After the retrieval, the retrieval results appear, as shown in Figure 5-2.



Figure 5- 2 Object Lookup Retrieval Results

Step 4: In the retrieval result, you can click **Generate Trend Report** in the upper right corner of the interface to export the trend report in PDF format, as shown in Figure 5-4.

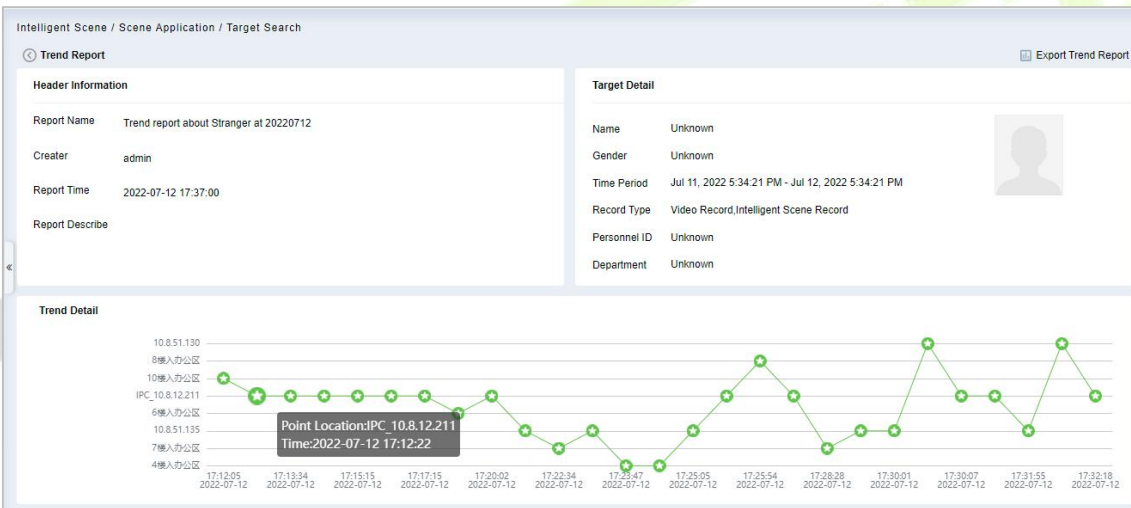

Figure 5- 3 Trend Report

Record Detail					
Event Time	Region	Event Source	Image	Event Name	Event Grade
Jul 12, 2022 5:12:05 PM	Area Name	10楼入办公区		Stranger	Abnormal
Jul 12, 2022 5:12:22 PM	地图	IPC_10.8.12.211		Face Detection Alarm	Normal
Jul 12, 2022 5:13:34 PM	地图	IPC_10.8.12.211		Face Detection Alarm	Normal
Jul 12, 2022 5:14:31 PM	地图	IPC_10.8.12.211		Face Detection Alarm	Normal
Jul 12, 2022 5:15:15 PM	地图	IPC_10.8.12.211		Face Detection Alarm	Normal

Figure 5- 4 Trend Report

Intelligent Analysts detection based on video face recognition function, need to set specific function detection time period (CBL223-C01 /ZKIVA-Edge T1 supported).

5.1.2 Personnel Control

Through the construction of various types of key personnel to monitor the face database, the front-end camera is used for face capture, comparison and recognition, and an early warning is issued when the database hits.

Note: If you use Face recognition camera, such as CBL223-C01, please access the CBL223-C01 web page and make sure you have enabled the facial recognition function. Then follow the IPC Connection-Target list library to sync the list library to camera.

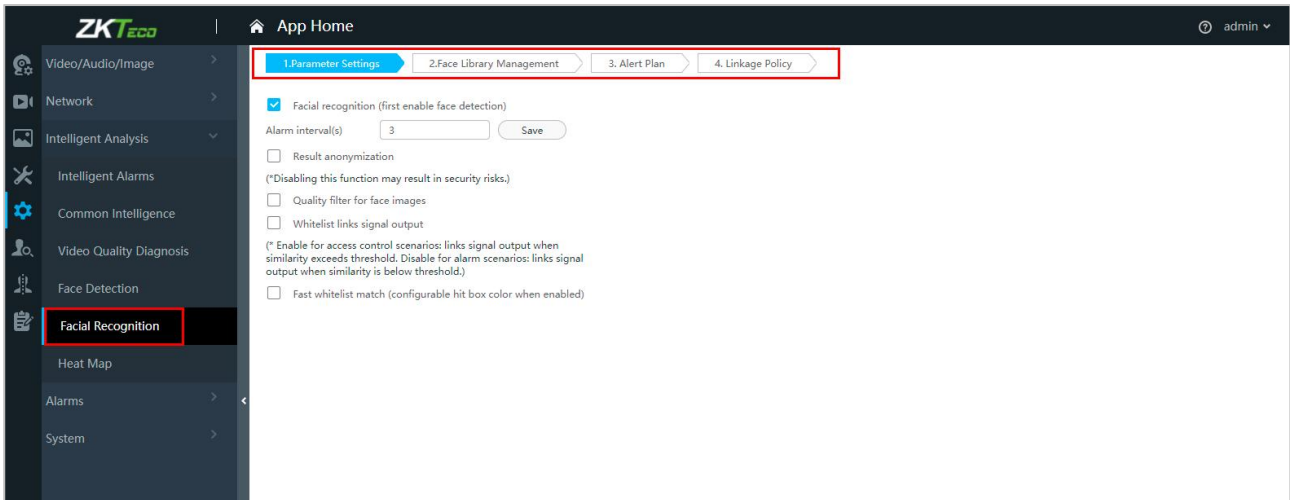

Figure 5- 5 Facial Recognition Interface

5.1.2.1 Personnel List Setting

Introduces the operation of the personnel list library creation function set in the People Control pre-set.

Operating Steps:

Step 1: In the **Personnel** module, select **Personnel Management > List Library**.

Step 2: Click **Add**, configure the relevant parameters, and complete the new list library.

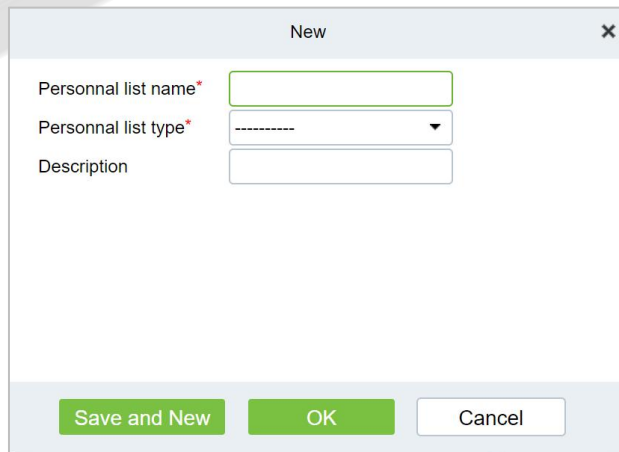

Figure 5- 6 Added Personnel List Library Interface

Step 3: Click the "Add Person" button on the right side of the list database information to add the personnel registered to the system to the list database, as shown in Figure 5-7.

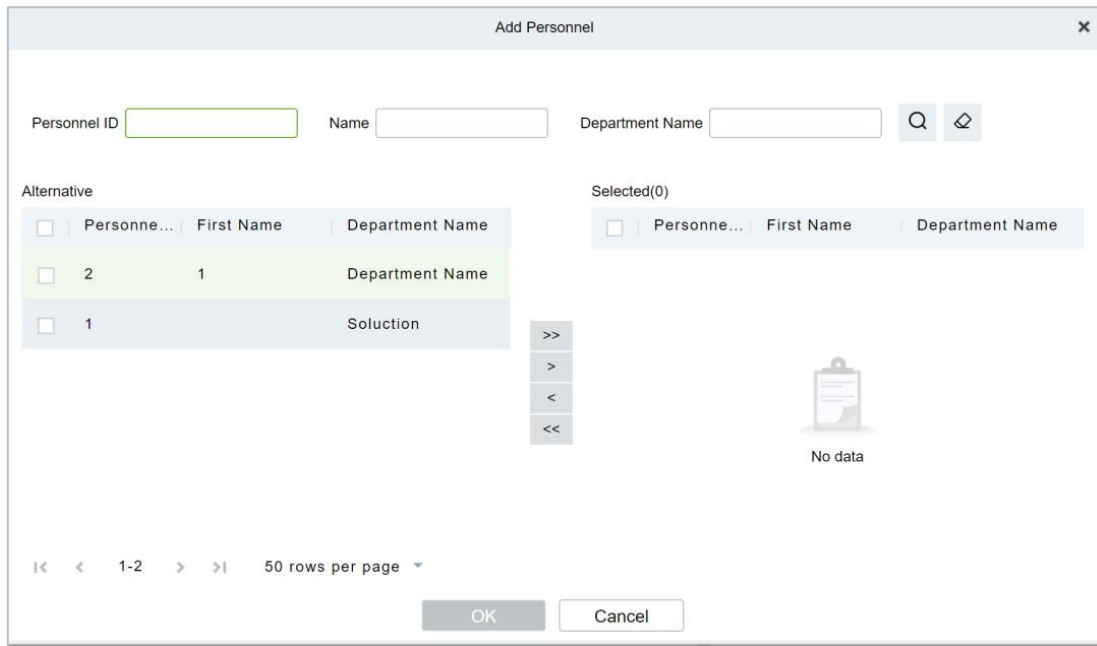

Figure 5- 7 Add People to The List

5.1.2.2 Personnel Control

Introduce the operation Steps to realize the People Control function.

Operating Steps:

Step 1: Introduce the operation Steps to realize the People Control function.

Step 2: Click the **New** button on the application configuration interface, and in the pop-up new function pop-up window, select the **Personnel Control** option page, and set the corresponding control detection conditions, as shown in Figure 5-8. For parameter descriptions, please refer to Table 5-1 shown.

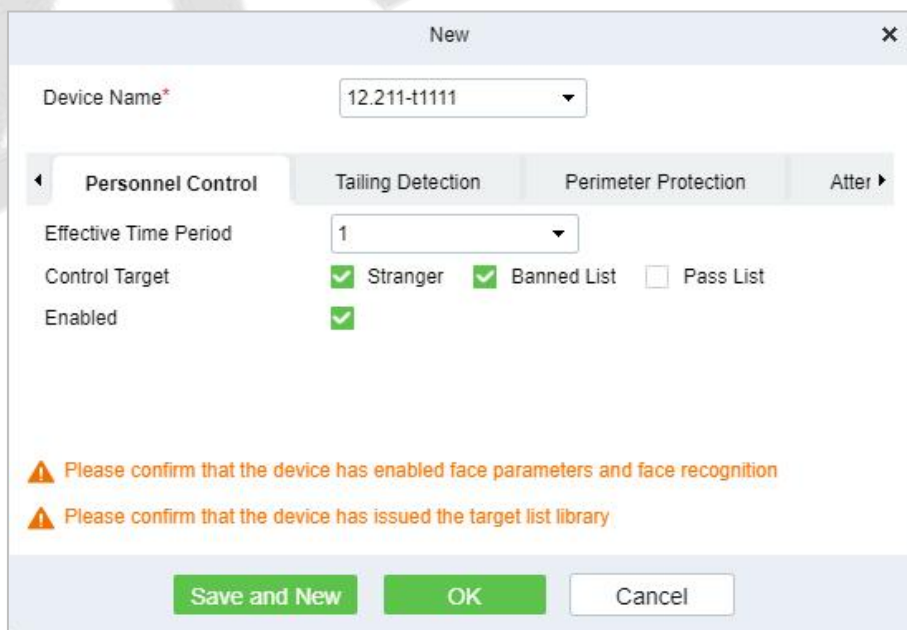

Figure 5- 8 Added Personnel Control

Field Name	Field Definition
Device Name	Select the camera device for face control detection.

Effective Time Period	The People Control strategy detection period. Only the time period list can test the content of "16.4 Pre-settings".
Control Target	People Control strategy event record detection control target. For the specific list, please refer to the "16.5.1 Personnel List Settings" section.
Enable	Enable status switch of People Control policy.

Table 5- 1 Personnel Control Setting Parameter Description

Step 3: Click **OK** to save the settings.

Result Verification

Operating Steps:

Step 1: In the **Intelligent Analysis** module, select **Scene Application > Personnel Control**.

Step 2: The information displayed on the Personnel Control interface is the real-time monitoring information of the control settings that have taken effect in the system, as shown in Figure 5-9, and the interface description is shown in Table 5-2.

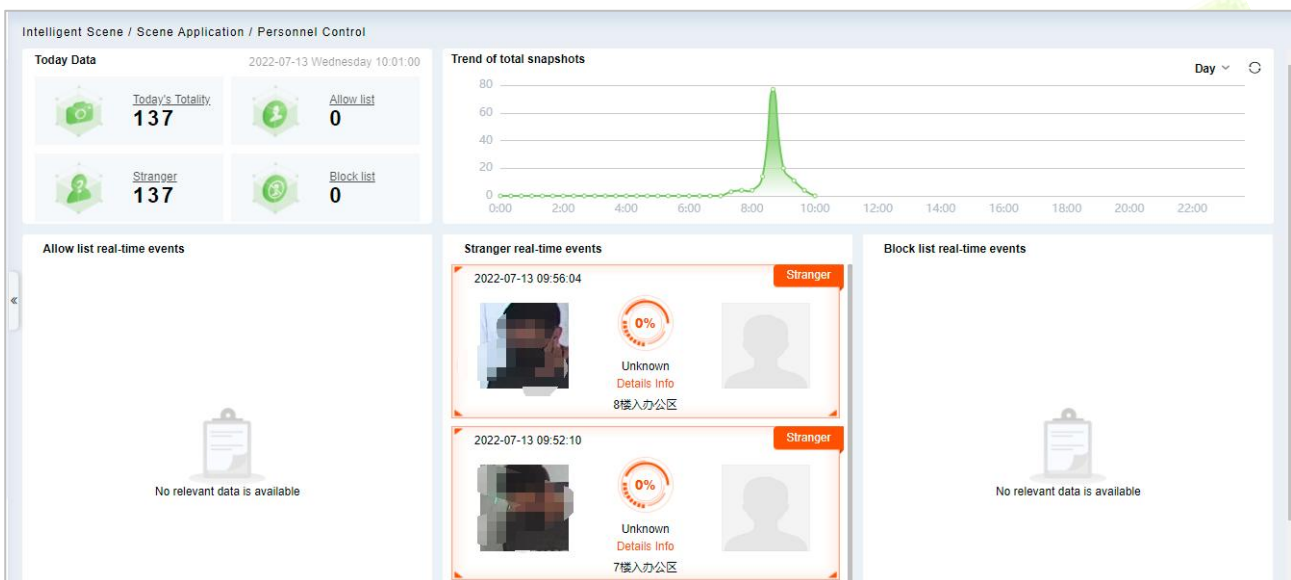

Figure 5- 9 Personnel Control Real-Time Monitoring Dashboard

Field Name	Field Definition
Today's data	Relevant data of personnel management and control on the day, including today's data of the total number of snapshots, strangers, banned lists, and allowed lists, and the data is updated in real time.
The total number of snapshots and the situation	The curve chart visually displays the occurrence trend of People Control events, including four-time dimensions of day, week, month, and year.
Allowed/ Strangers/ Forbidden List Real-time Events	Shows the real-time events of allowed/strangers/banned list personnel in real time. <ul style="list-style-type: none"> Each personnel control record includes the time of occurrence, snapshot photos, registered photos, similarity, library name, name, viewing related and other elements. Click the record area, support the pop-up box to view the event details of the record, click to view related, support to view other snapshot records of the person.

Table 5- 2 Parameter Personnel Control Real-Time Monitoring Dashboard

Right click the Capture pictures of strangers, you can Quickly find through pictures or add personnel.

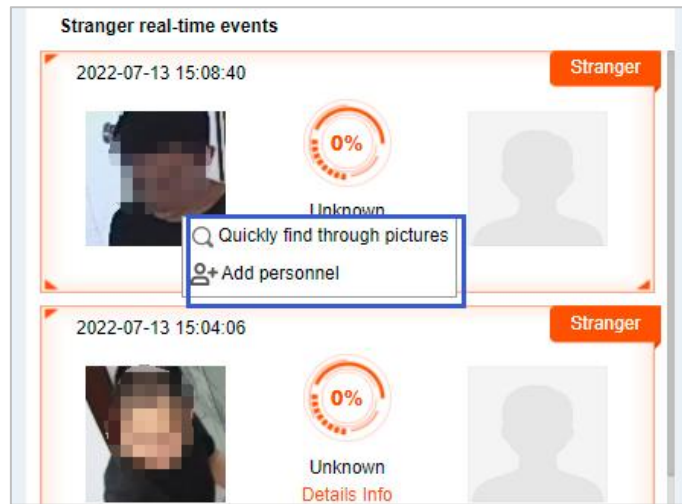

Figure 5- 10 Stranger Real time

Quickly find through pictures: Ability to quickly search for personnel trajectories through captured pictures.

Click **Quickly Find Through Pictures**, would be redirected to the target search interface for image search to generate the trajectory.

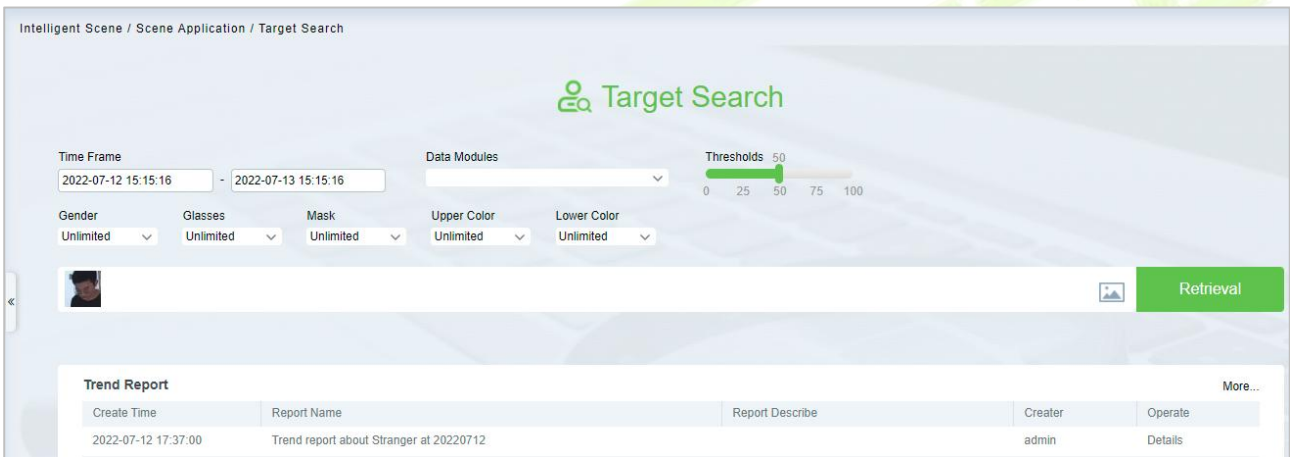

Figure 5- 11 Target Search Interface

Add Personnel: Quickly add captured faces to list library.

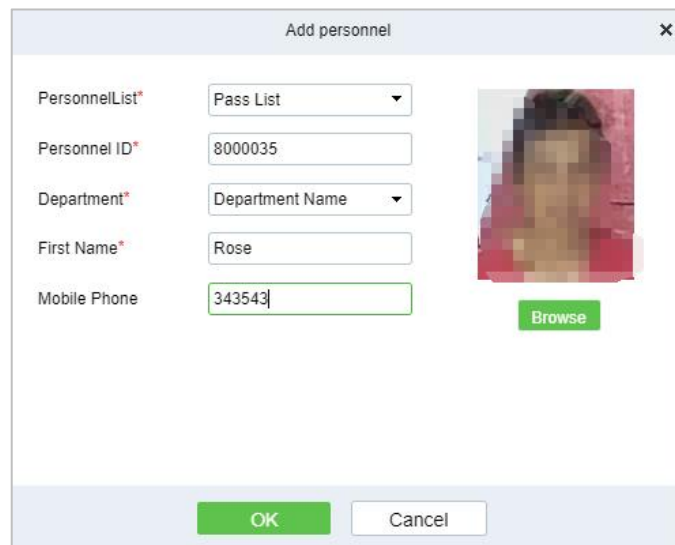

Figure 5- 12 Add Personnel Option

Note: The system will automatically detect whether the captured face photo is up to standard, and the pixel is not clear will prompt the addition to fail.

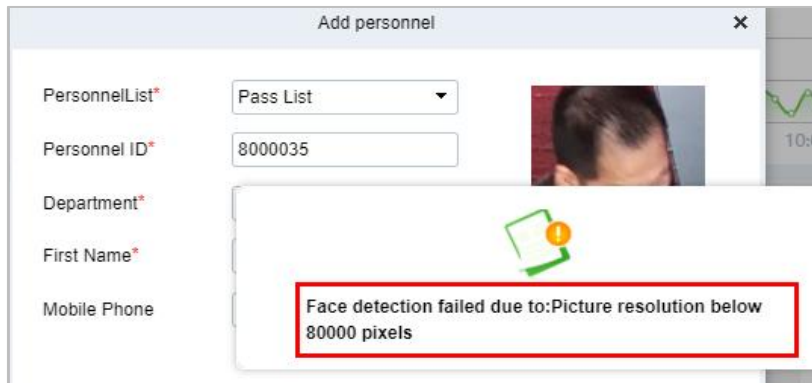

Figure 5- 13 Add Personnel Option

5.1.3 Tailing Detection

The video face recognition is linked with the door opening event record of the **Access Control** module, and the Intelligent camera captures the face and compares it to determine the identity and job number of the person and compare it with the job number of the access control event. Entering, the snapshot cannot confirm the identity of the stranger, and realizes the key monitoring and prevention of Tailing Detection (CBL223-C01/ZKIVA-Edge T1 supported).

5.1.3.1 Tailing Detection

Prerequisites:

please enable CBL223-C01 or ZKIVA-EdgeT1 face recognition function, and sync the face library, please refer to People Control.

Operating Steps:

Step 1: In the **Intelligent Analysis** module, select **Service Configuration > Application Configuration**.

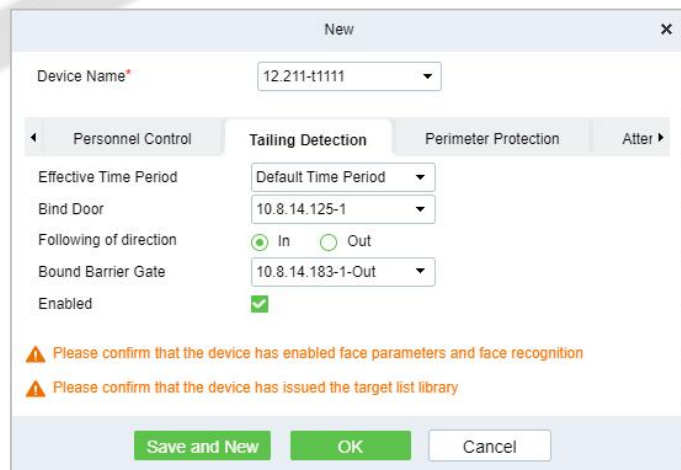

Figure 5- 14 New Tailing Detection Settings

Parameter Name	Parameter Description
Device Name	Select the camera to set the Tailing Detection function.
Effective Time Period	Set the effective time period of the Tailing Detection function, and the time period list can refer to the content in "16.4 Pre-settings".

Binding Door	Binding Door Select the door information bound to the camera with the Tailing Detection function.
Monitoring Direction	Set the direction of entrance and exit to be monitored.
Binding Channel	Select the channel information that the Tailing Detection function is bound to the camera.
Enable	The Tailing Detection settings enable switch.

Table 5- 3 Description of Tailing Detection Parameters

Step 2: Click **OK** to save the settings.

5.1.3.2 Result Verification

Operating Steps:

Step 1: In the **Intelligent Analysis** module, select **Scene Application > Tailing Detection**.

Step 2: Perform real-time monitoring and viewing of relevant records according to the Tailing Detection doors, as shown in Figure 5-15.

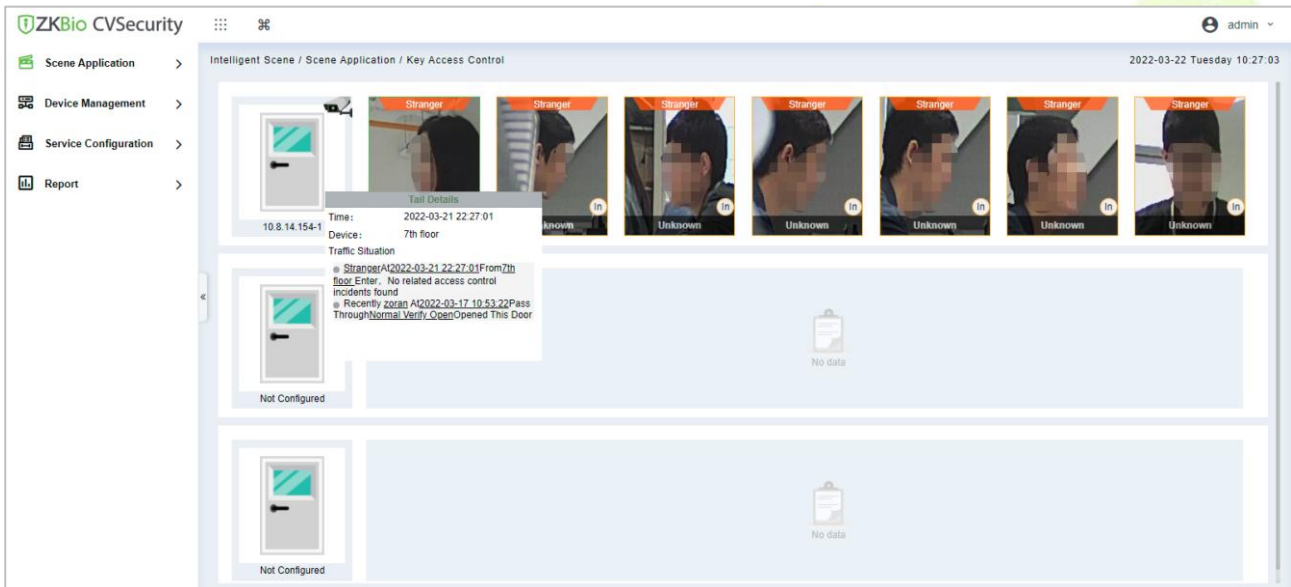

Figure 5- 15 Tailing Detection Interface

5.1.4 Perimeter Protection

Through the intelligent camera crossline analysis function, Perimeter Protections are delineated in the anti-crossing areas in passages, boundaries, entrances and exits, and alarms are triggered when crossing the fence. The crossing fence realizes the empowerment and supplementation of equipment such as access gates, physical fences, and security gates, and analyzes and warns illegal crossing behaviors through computer vision.

Operating Steps:

Step 1: Access the camera web page, set the line statistics, and draw lines, as shown in Figure 5-16.

Note:

1. Please refer to the hardware suggestion list to check the supported camera. access the web page and select "Tripwire" to set the line crossing.

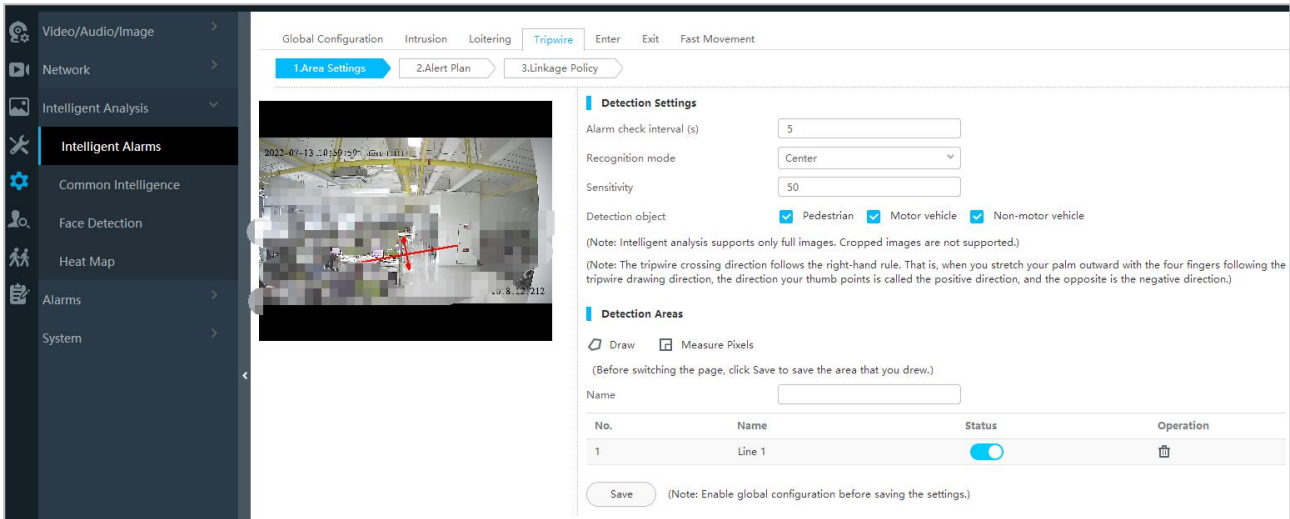

Figure 5- 16 Set the Camera Line Crossing to Draw the Line

2. About the ZKIVA-Edge T1 setting, please refer to Perimeter alarm setting.

Step 2: In the Intelligent Scenario module, select **Service Configuration > Application Configuration**.

Step 3: In the application configuration interface, click **New** button, select the **Perimeter Protection** tab, and set the relevant parameters, as shown in Figure 5-17. For parameter descriptions, please refer to Table 5-4.

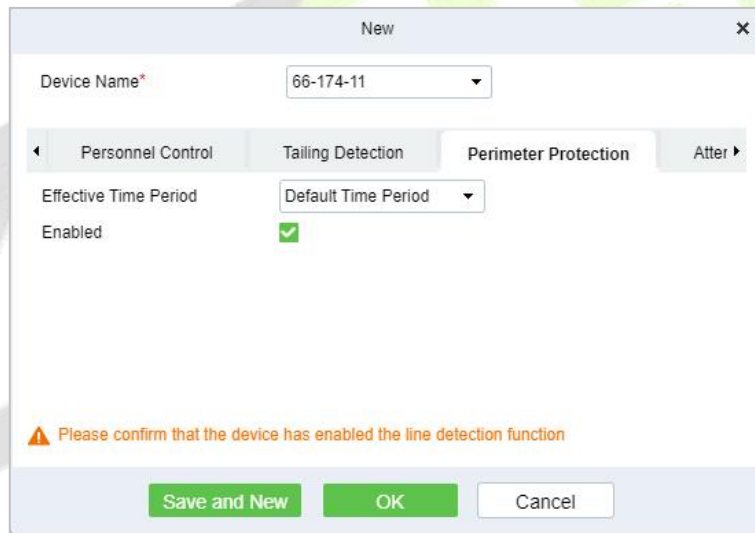

Figure 5- 17 New Perimeter Protection Settings

Parameter Name	Parameter Description
Device Name	Select the camera to set the line-crossing function.
Effective Time Period	Set the effective time period of the perimeter protection function
Enable	The Tailing Detection settings enable switch.

Table 5- 4 Cross Fence Parameter Settings

Step 4: Click **OK** to save the settings.

5.1.4.1 Result Verification

Operating Steps:

Step 1: In the **Intelligent Analysis** module, select **Scene Application > Perimeter Protection**.

Step 2: View real-time monitoring data on this interface, as shown in Figure 5-18.

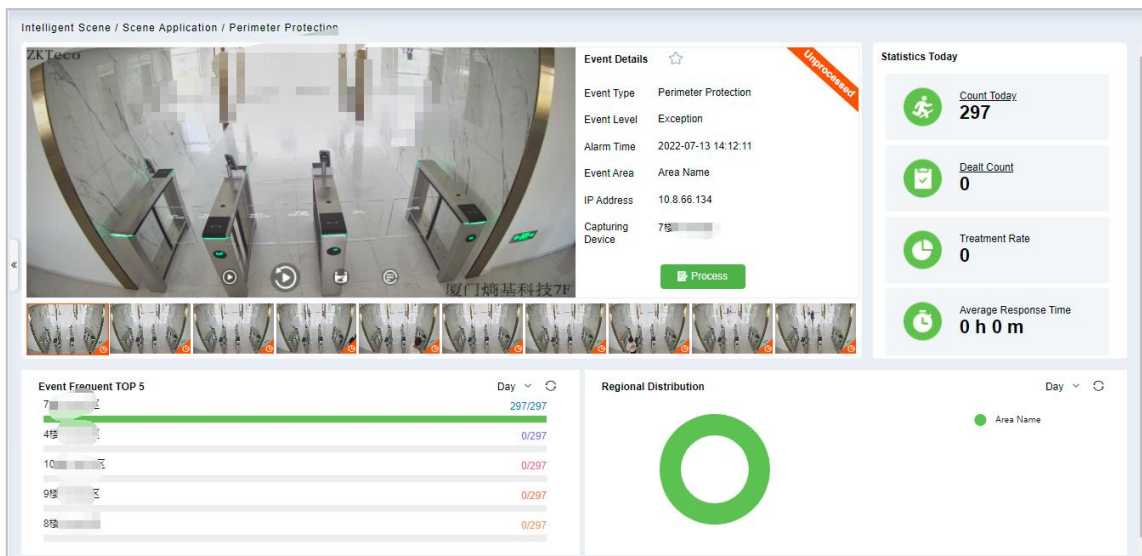

Figure 5- 18 Perimeter Protection Dashboard

- : Real-time preview the video.
- : Playback the linkage video.
- : Check the snap picture.
- : Check the event details.

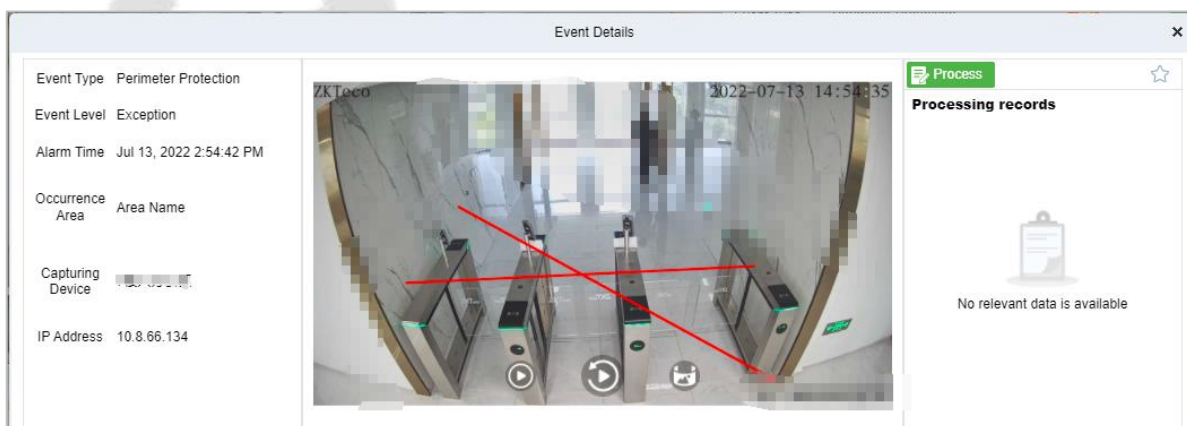

Figure 5- 19 Perimeter Protection Event Details

Click ,you can deal with and mark the event.

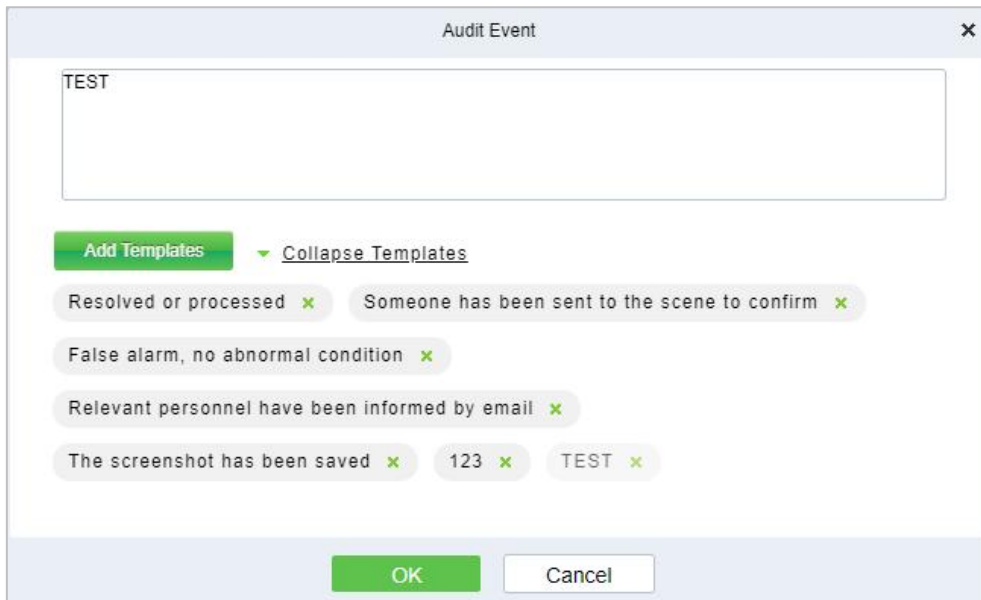



Figure 5- 20 Perimeter Protection Audit Event

After auditing the events, the icon will mark to  symbol.

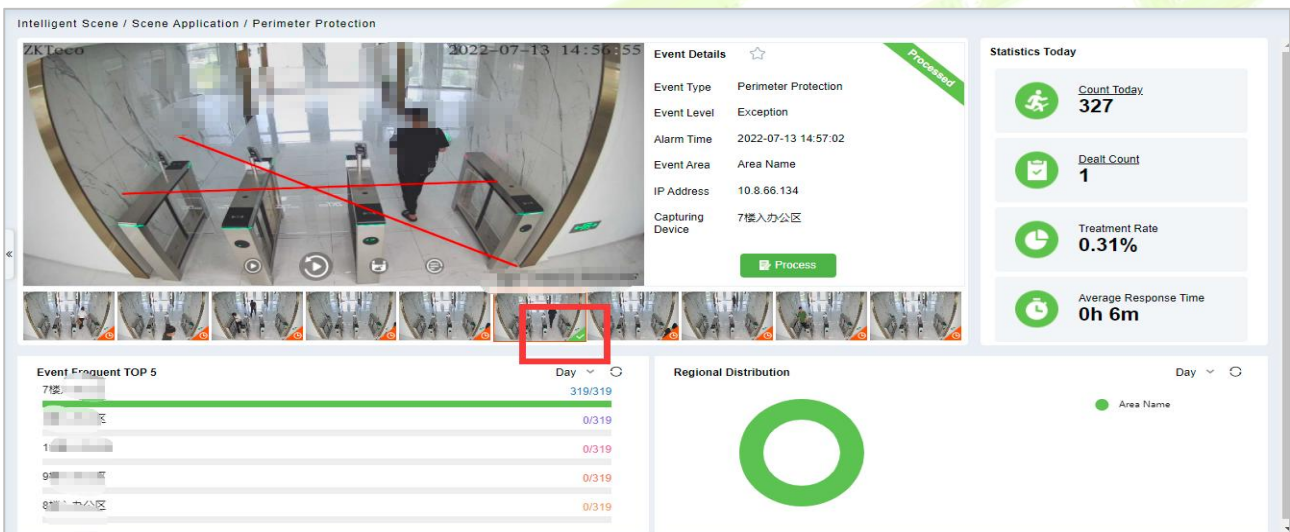

Figure 5- 21 Perimeter Protection Event Interface

5.1.5 Attendance Checking Detection

Through the intelligent camera people counting function to realize the monitoring and alarm of leaving work and leaving the post, by demarcating the monitoring area, setting the monitoring of leaving work and leaving the post, the camera calculates the number of people in the area in real time, and triggers the alarm of leaving work and leaving work when no one is on duty. This function is mainly used for monitoring security Business scenarios that need to be always on duty, such as rooms, monitoring rooms, and sentry posts.

Preconditions:

The camera supports (D series) and the Crowd Density function parameter is enabled. See **Crowd Density** (Please refer to the hardware suggestion list to check the supported devices).

5.1.5.1 Attendance Checking

Operating Steps:

Step 1: Log in to the camera settings interface, select the **Crowd Density** tab in the **Advanced Configuration > Intelligent Analysis > General Intelligence** interface, and check to enable the Crowd Density function, as shown in Figure 5-22.

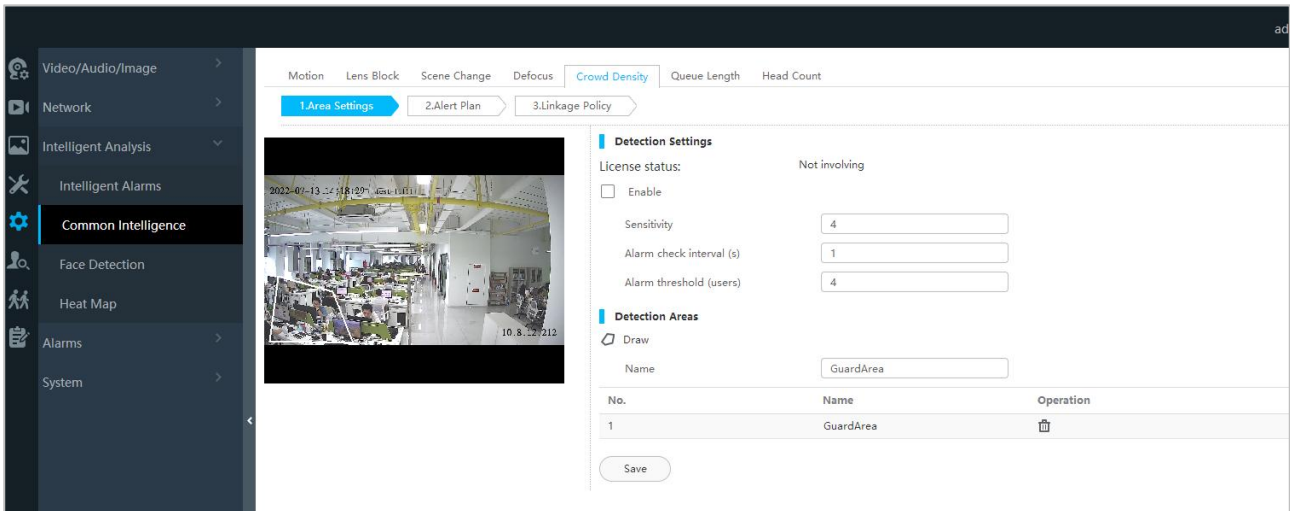

Figure 5- 22 Crowd Density Monitoring with Built-In Camera

Step 2: In **Intelligent Analysis** module, choose **Service Configuration > Application Configuration > New**. Select **Attendance Checking**.

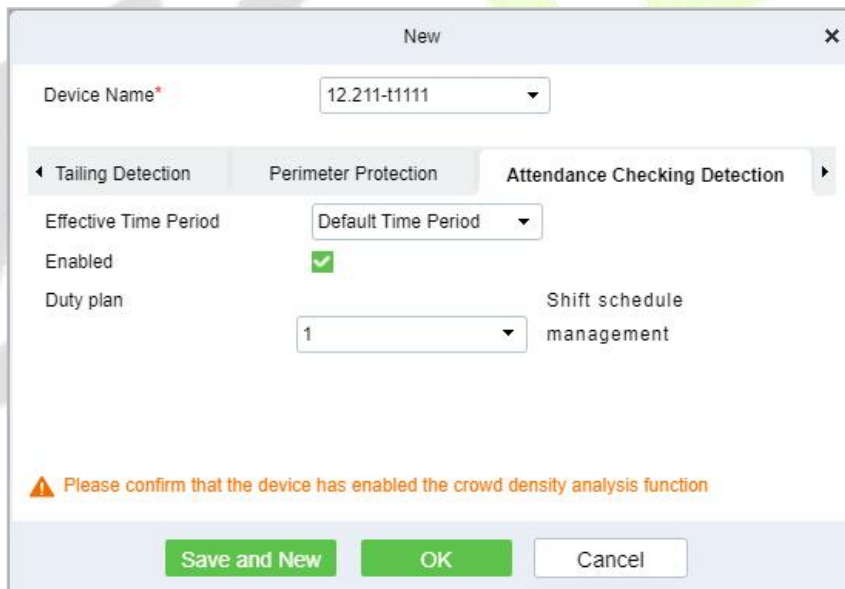

Figure 5- 23 Add Attendance Checking

Parameter Name	Parameter Description
Device Name	Select the camera to set the cross-limit bar function.
Effective Time Period	Set the effective time period of the attendance checking.
Enable	Enable attendance checking detection.
Duty Plan	Click shift schedule management to set the duty plan.

Table 5- 5 Resignation Parameter Description

Step 4: Click **OK** to save the settings.

5.1.5.2 Result Verification

Operating Steps:

Step 1: In the **Intelligent Analysis** module, select **Scene Application > Attendance Checking Detection**.

Step 2: The relevant data can be viewed in this real-time monitoring interface, as shown in Figure 5-24.

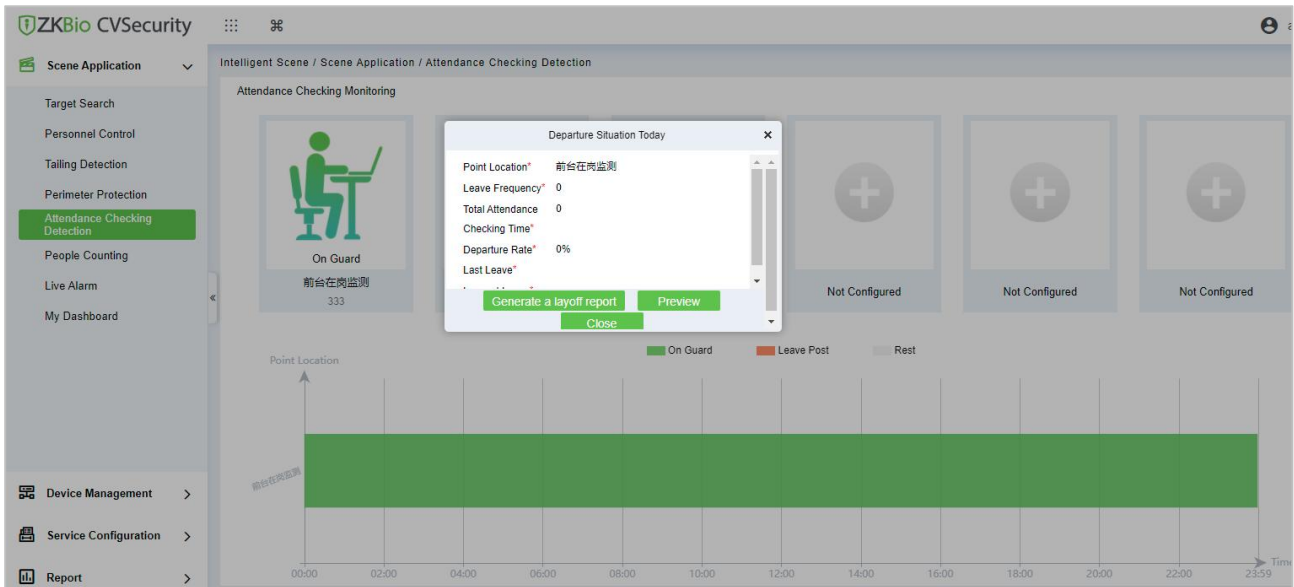

Figure 5- 24 Attendance Checking Dashboard

Step 3: Click the **On Guard** icon, you can check the departure situation today, and generate the off-duty report.

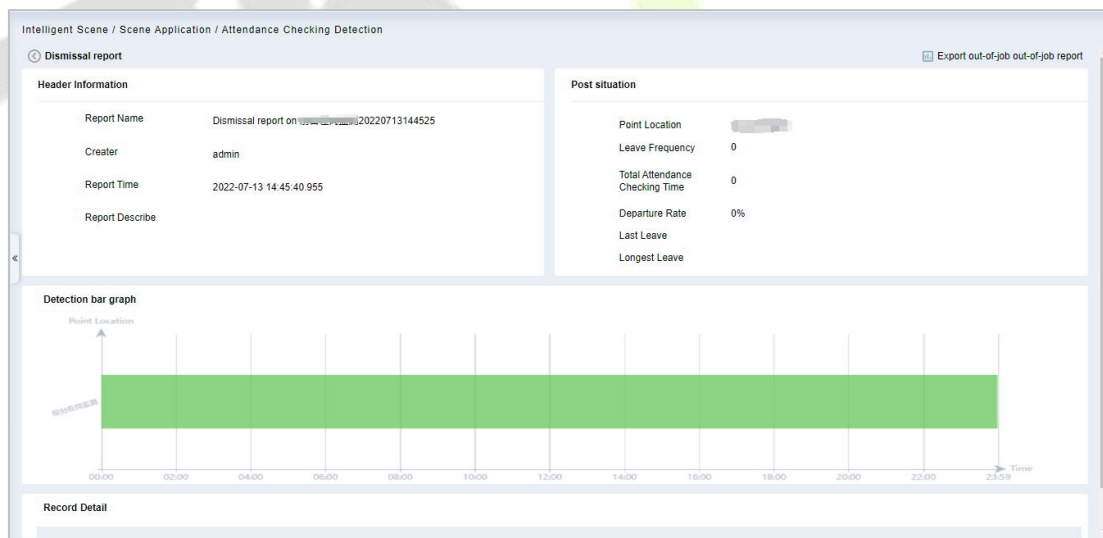

Figure 5- 25 Report

5.1.6 People Counting

Counting the number of people entering and leaving the area through the crossing line statistics function of the Intelligent camera, entering +1, going out -1, setting the area capacity, calculating the number of people in the area, dynamically displaying whether the area can enter the state, and realizing its business needs, especially to meet the current epidemic situation. In the context, the passenger flow control of supermarket stores.

5.1.6.1 Result Verification

Operating Steps:

Step 1: In the **Intelligent Analysis** module, select **Scene Application > People Counting**.

Step 2: The relevant dynamic data can be viewed in the real-time monitoring interface of regional people statistics, as shown in Figure 5-43.

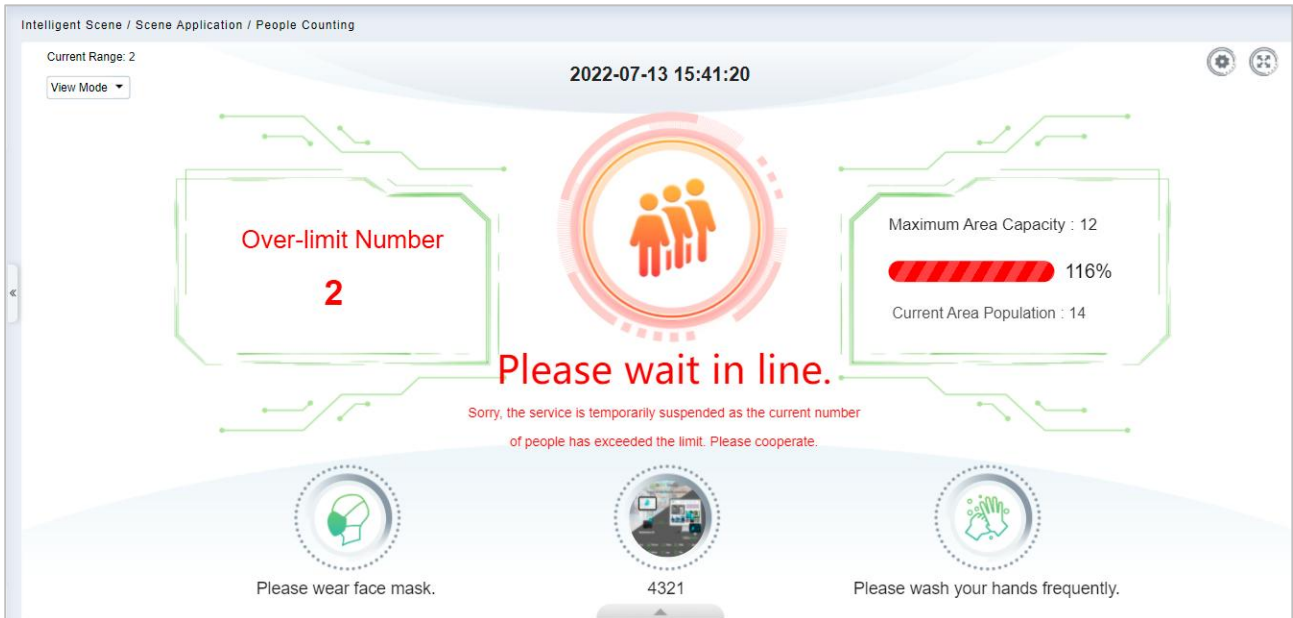

Figure 5- 26 People Counting Dashboard

You can change the icon that fits this area, click the icon that you can change it.

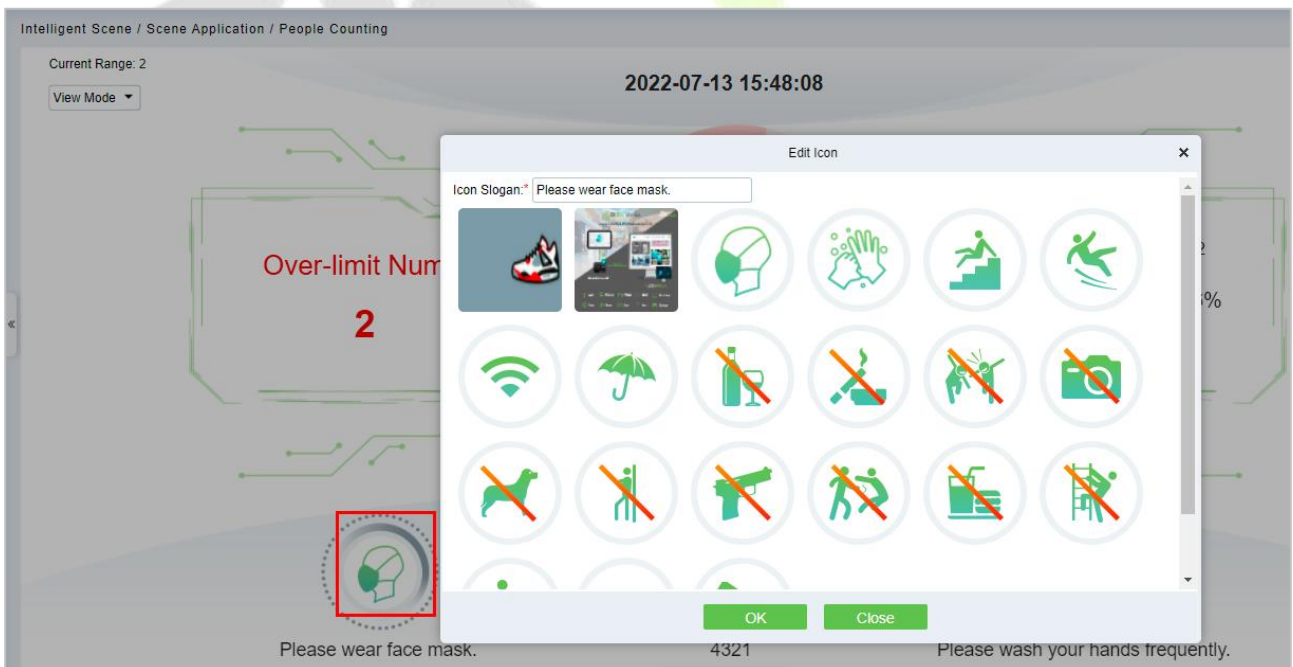

Figure 5- 27 Icon Setting

Also you can check the Peak periods of passenger flow and footfall.

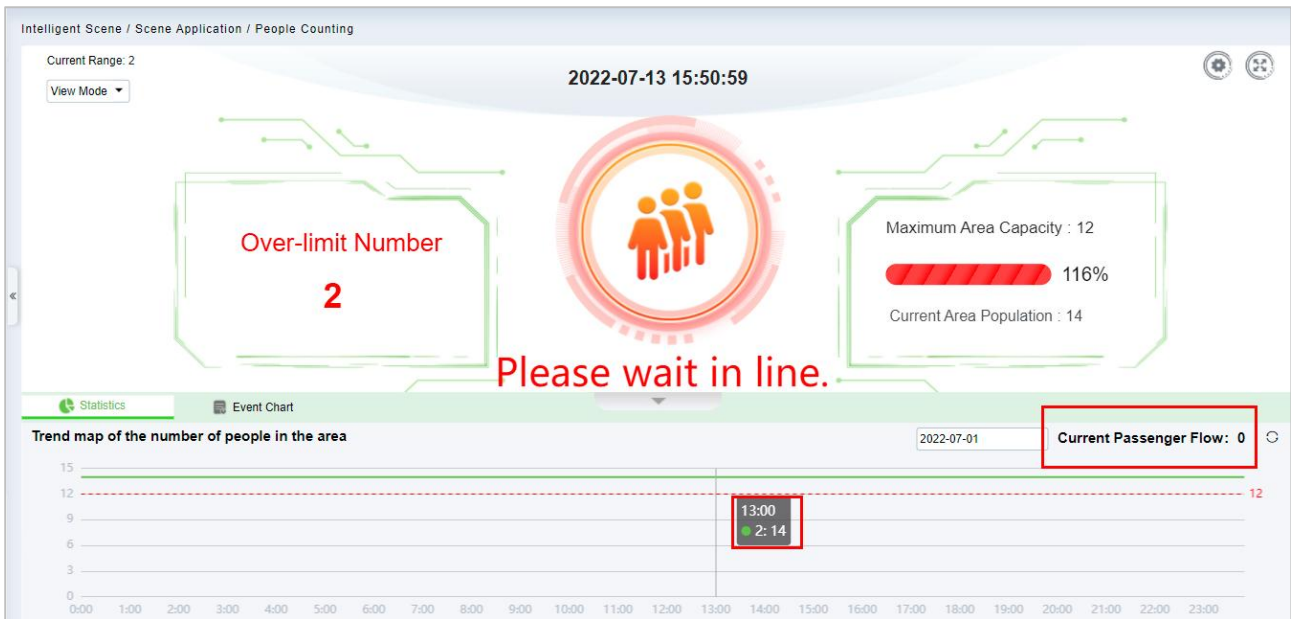

Figure 5- 28 Passenger Flow Statistics

5.1.7 Live Alarm

Alarm events generated by all devices in the **Intelligent Analysits** module.

5.1.8 My Dashboard

Users can customize the personal data dashboard according to conditions.

Operation Guide:

Step 1: Go to **Intelligent Analysits > Service Configuration > Dashboard Configuration**.

Step 2: Click **New** Button, according to the condition to set the dashboard.

New

Configuration Name* Today's not processed eve Add Filter Audit Event

Limit Count* 10 Is it public? Yes No

Condition

Audit Event Unprocessed

Save and New OK Cancel

Figure 5- 29 New My Dashboard

Parameter	Parameter description
Configuration Name	User-defined the dashboard name.
Add Filter	According to your dashboard to add the filter events
Limit Count	The number that needs to be displayed
Is it public?	Is it an individual view or can be seen by everyone
Condition	Configure the condition according to the filter

Table 5- 6 Parameter dashboard

Result Verification:

Go to **Scene Application > My Dashboard** to check the dashboard.

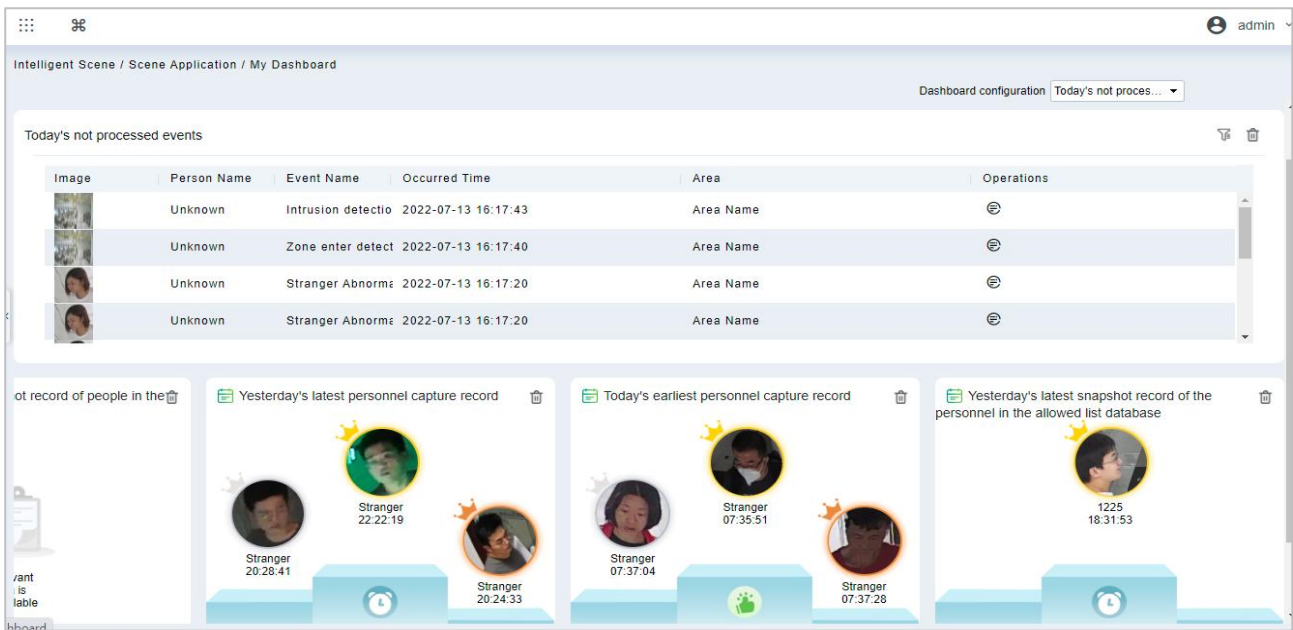

Figure 5- 30 My Dashboard

5.2 Device Management

Two device addition methods are supported, one is IPC directly connecting to ZKBio CVSecurity through SDK, and the other is ZKIVA-Edge connection.

5.2.1 IPC Connection (Currently, Only Support HWSDK Camera Connection, Please Check the Hardware Suggestion List)

Step 1: Go to **Intelligent Analysis > Device Management > Camera**, you can click Search or **New** to add the HWSDK Camera.

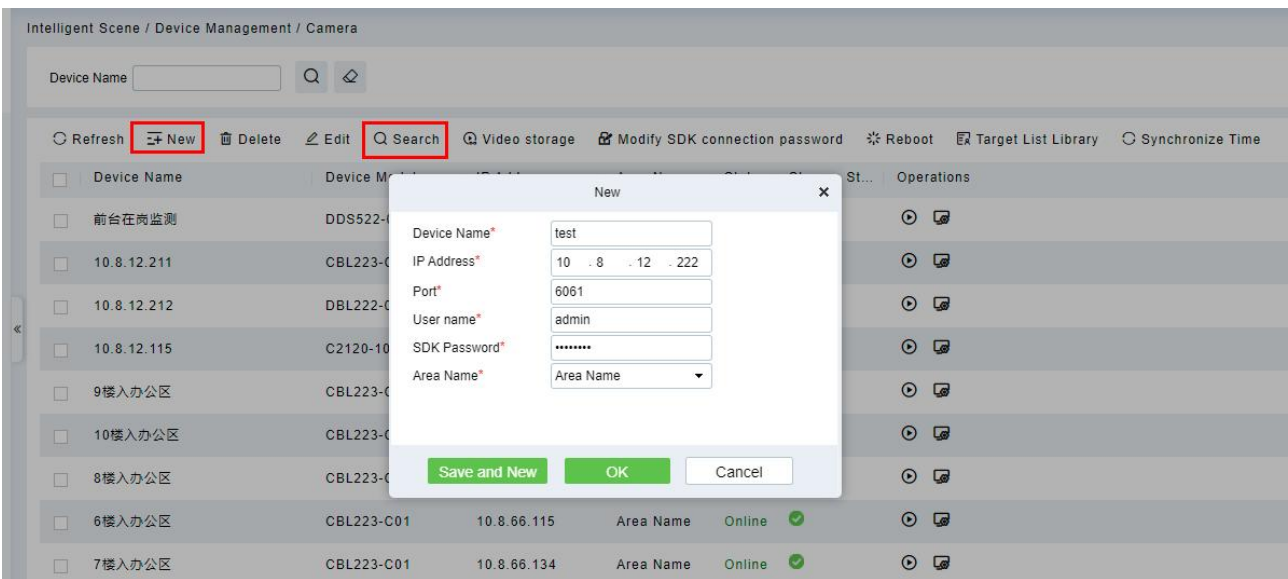

Figure 5- 31 Add Camera

Step 2: Click  , access the camera's web page to set the intelligent function.



Figure 5- 32 Access IPC Web Page

 Click this button to support directly adding IPC to NVR as a storage application. (NVR needs to be added to the **Video Management** module in advance).

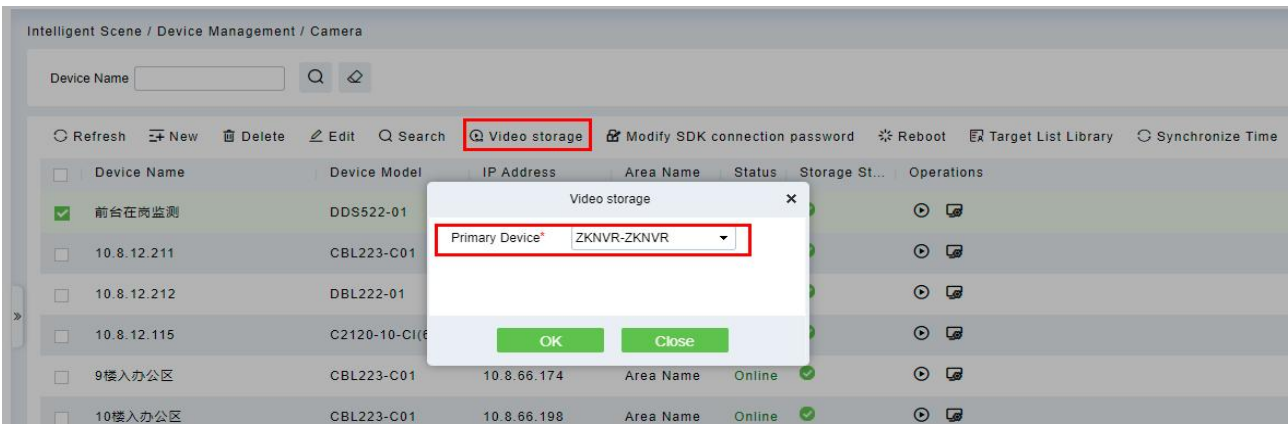



Figure 5- 33 Video Storage

After the completion, the Storage status would be change to .



Click this button to modify camera SDK password.

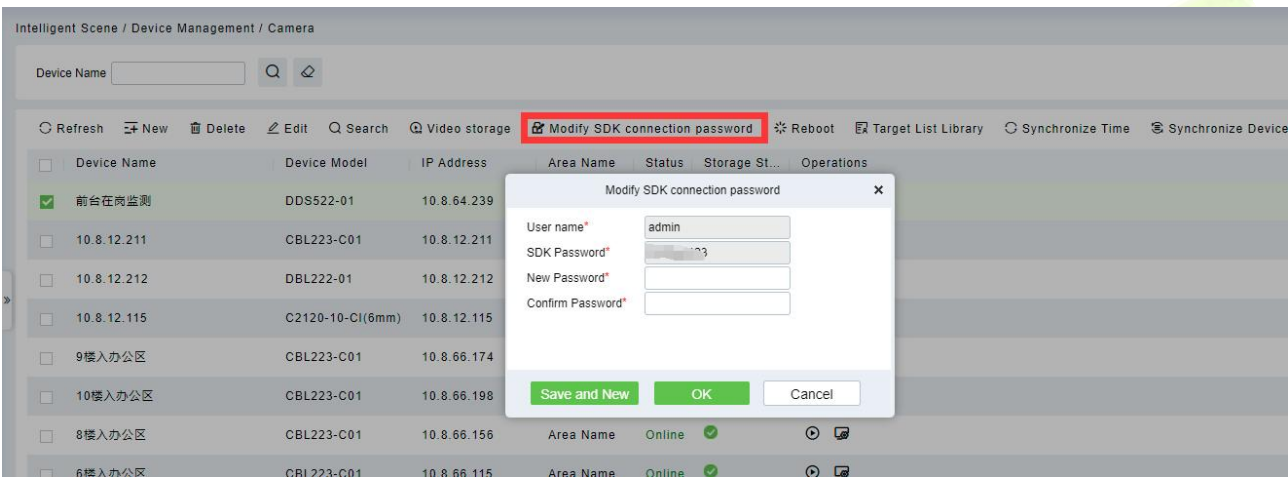

Figure 5- 34 Modify Sdk Password



Click this button to sync the face library (only CBL223-C01 supported), please select a list library, and sync.

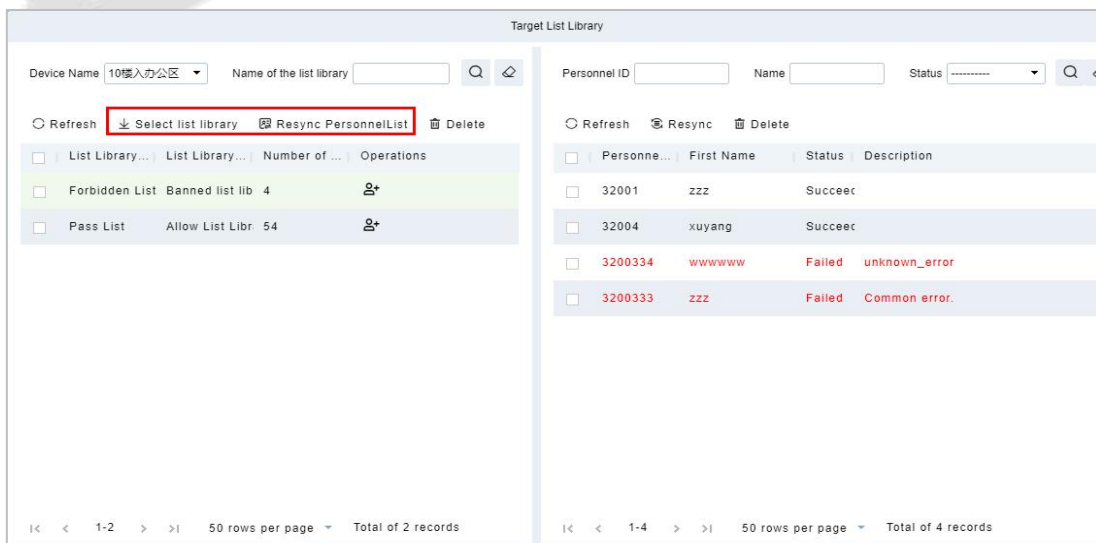

Figure 5- 35 Sync Xface Library



Click this button to Sync time to device.

Reboot Device:

It will reboot the selected device.

Synchronize Devices:

Synchronize data of the system to the device. Select device, click **Synchronize All Data to Devices** and click **OK** to complete synchronization.

Note: Synchronize Devices will delete all data in the device first (except transactions), and thus download all settings again. Please keep the internet connection stable and avoid power down situations. If the device is working normally, please use this function with caution. Execute it in rare user situations to avoid impact on normal use of the device.

5.2.2 ZKIVA-Edge Connection (Currently, Only Support ZKIVA-Edge T1 Connection)

(Smart Box)

Step 1: Go to **Intelligent Analysis > Device Management > Smart Box**, click **New** to add the Edge.

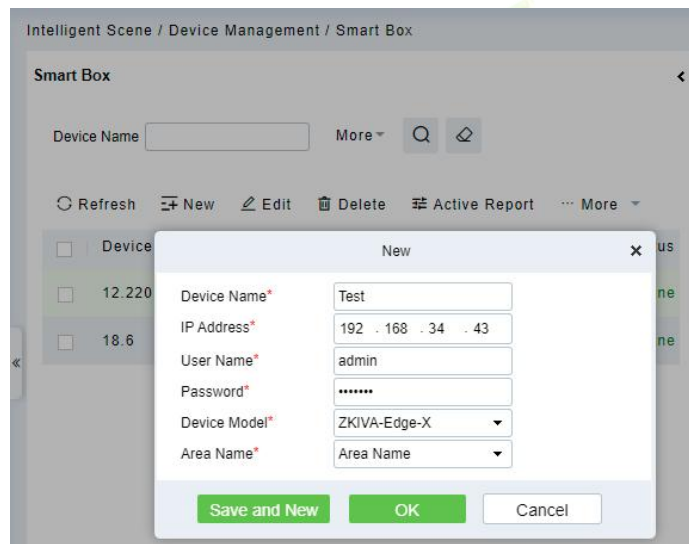

Figure 5- 36 Add ZKIVA-Edge

Step 2: Please add camera via RTSP. Select an Edge, click **New** on the right page, enter the details of the camera 's RTSP Stream.

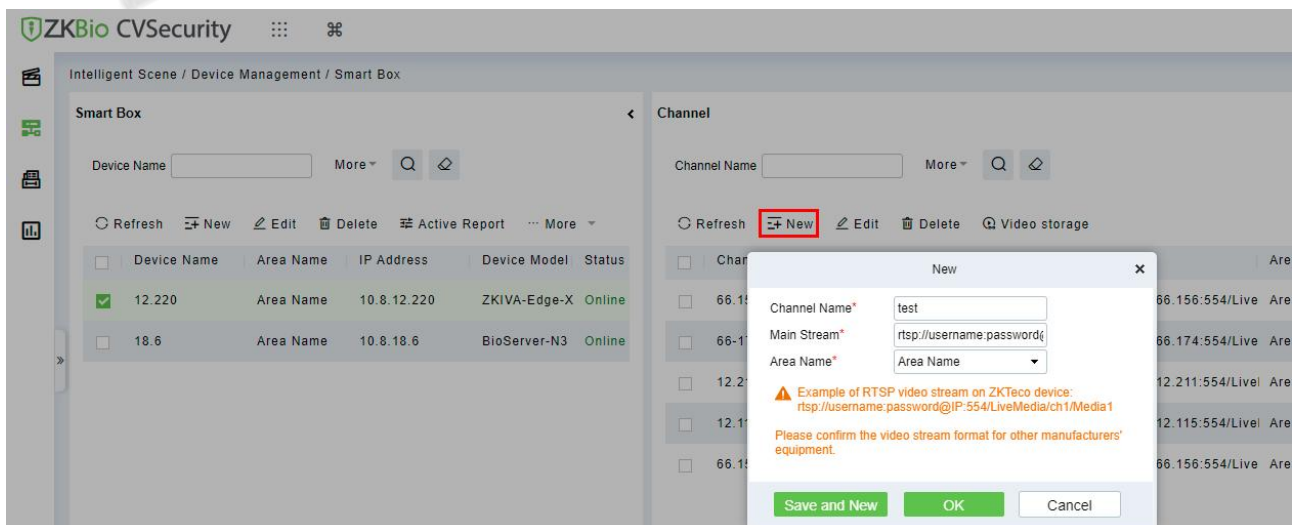

Figure 5- 37 Add Camera to ZKIVA-Edge

Note: RTSP Format

- a. **ZKBio X series:** rtsp://username:password@IP:554/LiveMedia/ch1/Media1.
- b. **ZKIPC series:** rtsp://sername:password@IP:554/ch01.
- c. **Other Branchs:** Please contact the vendor to get the corresponding RTSP format.

Result:

After adding, you can check the status and preview the video.

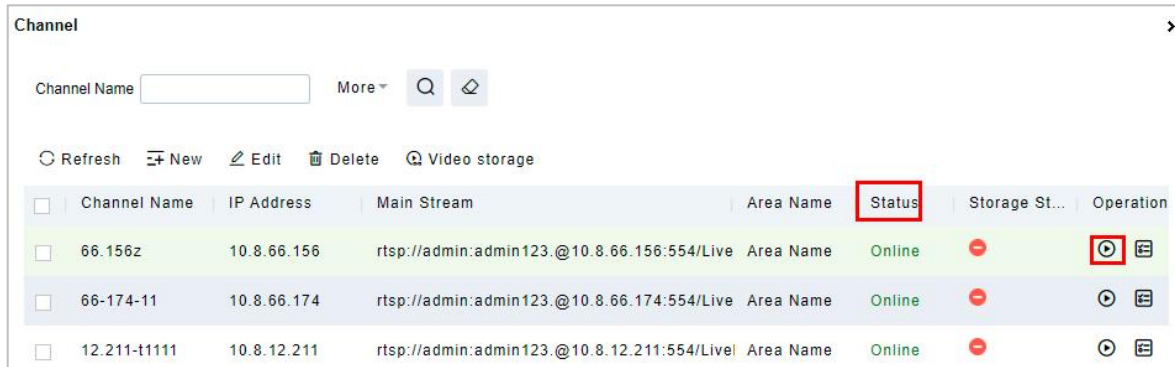

Figure 5- 38 Check the Status

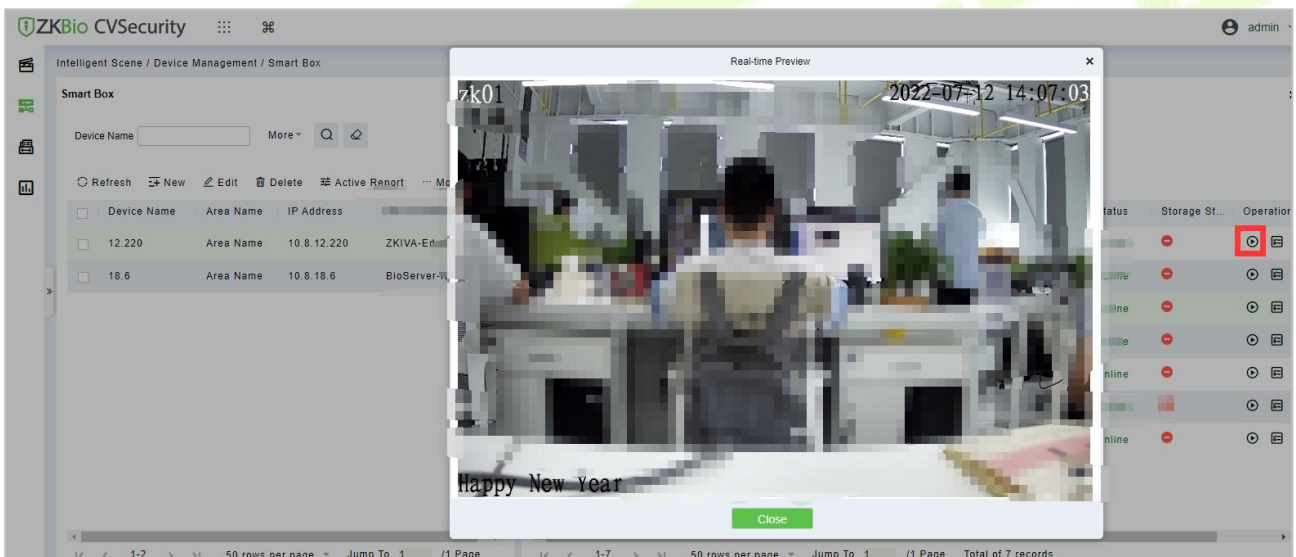

Figure 5- 39 Preview

Step 3: Click a camera, click to config the channel.

ZKIVA-Edge T1: Support 2 intelligences: Face Recognition and Perimeter Alarm.

ZKIVA -Edge T1(16CH): Supports up to 16 channels, and can be intelligently functioned with 16 channels (16 face recognition or 16 perimeter protection, or 8 faces + 8 perimeters, etc.)

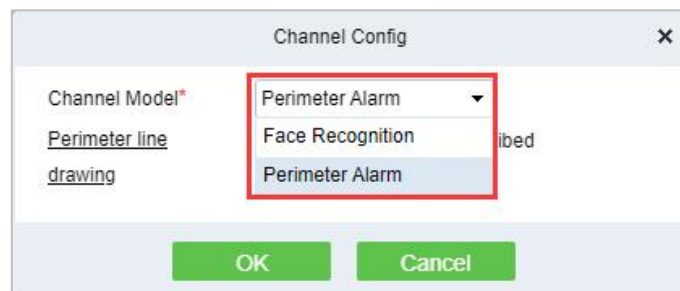

Figure 5- 40 Channel Config

Perimeter Alarm: Based on Line crossing, it implements the functions of intrusion detection and perimeter protection.

Face Recognition: Based on the face recognition function, it realizes the classification and linkage management of personnel identification of different list databases

5.2.2.1 Face Recognition

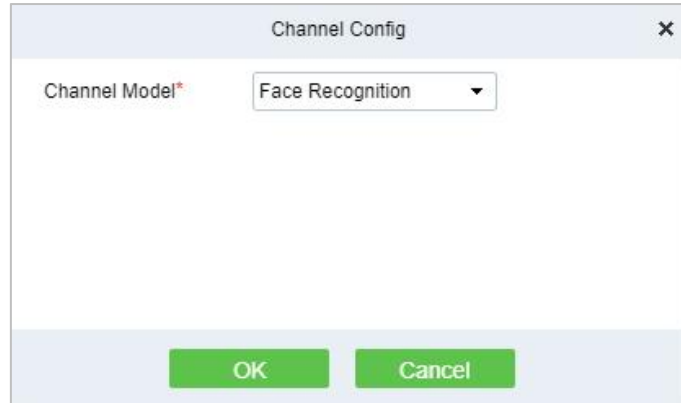

Figure 5- 41 Face Recognition Config

5.2.2.2 The Configuration of The Target List Library

Operation Guide: [More](#)

Step 1: Select an Edge, click **Target List Library**, select list library, and sync the personnel.

Note: Please go to Personnel module to create the list library firstly.

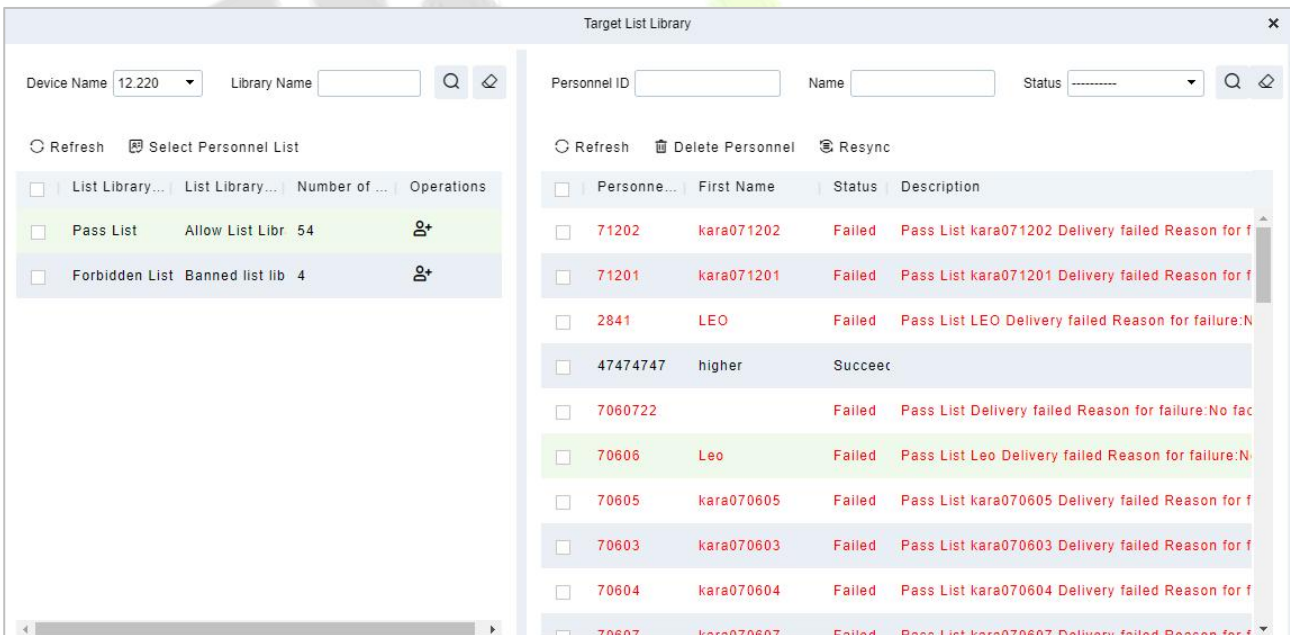

Figure 5- 42

Step 2: Select an Edge, click **Active Report** to report the picute to ZKIVA-Edge, as shown in Figure 5-43.

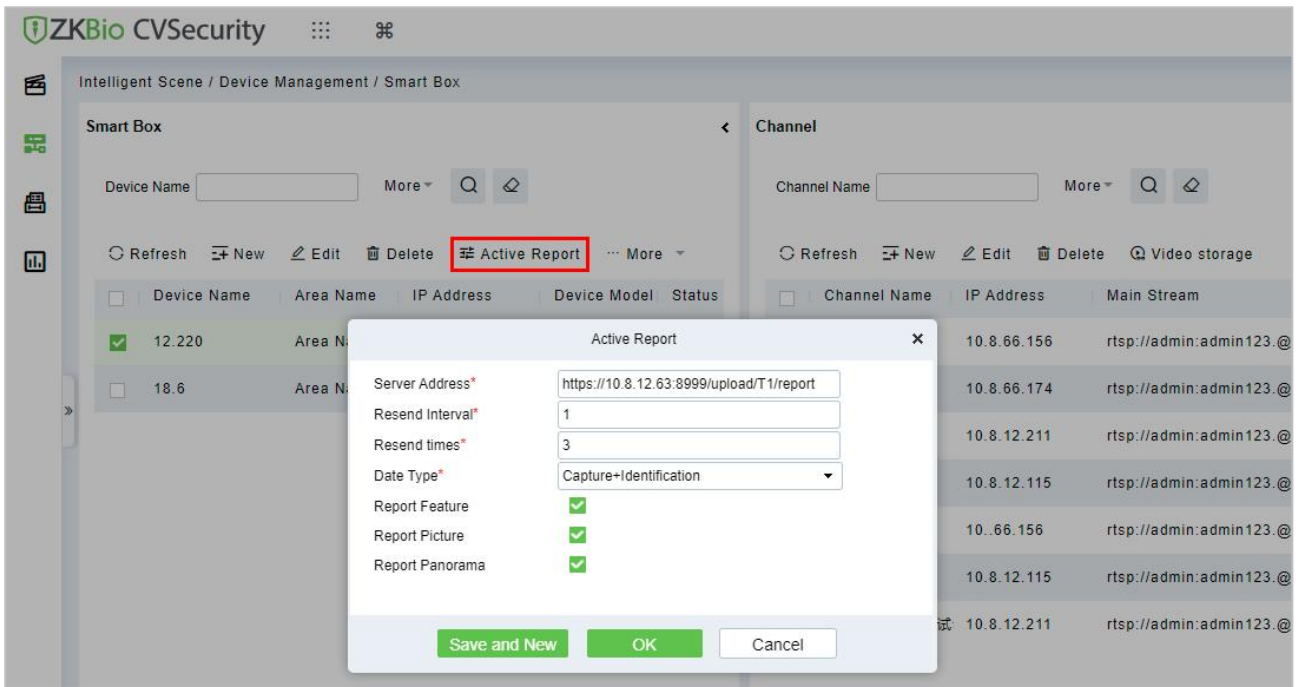

Figure 5- 43 Active Report

Paramater	Description
Server Address	Enter the address of the server to report
Resend Interval(s)	Sets the resend interval for the same event
Resend Times	Sets the number of resendings for the same event
Date Type	Set the reporting data type, and the option supports "capture, recognition, capture + recognition"
Report Feature	Select whether to enable character reporting
Report Picture	Select whether to enable report images
Report Panorama	Select whether to enable report panoramas

Table 5- 7 Active Reporting Parameter Description

Result:

Please refer to the setting, after config, please check the people control dashboard.

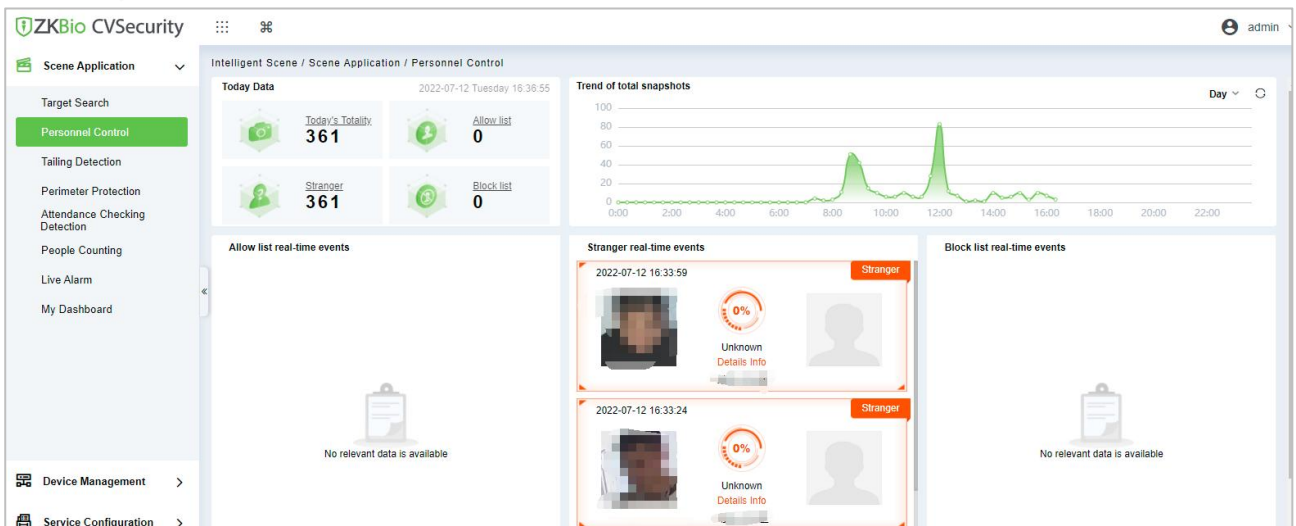

Figure 5- 44 People Control

5.2.2.3 Perimeter Alarm

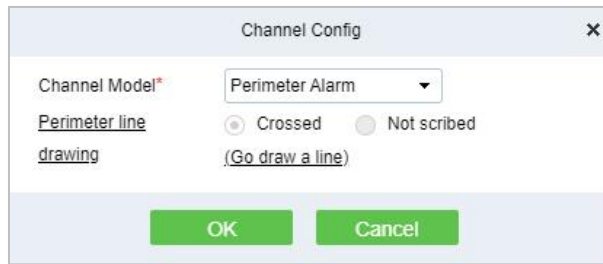

Figure 5- 45

Figure 5-45 Channel Configuration option

Step 1: Go to Channel Config and select Perimeter Alarm, click **Go draw a line**.

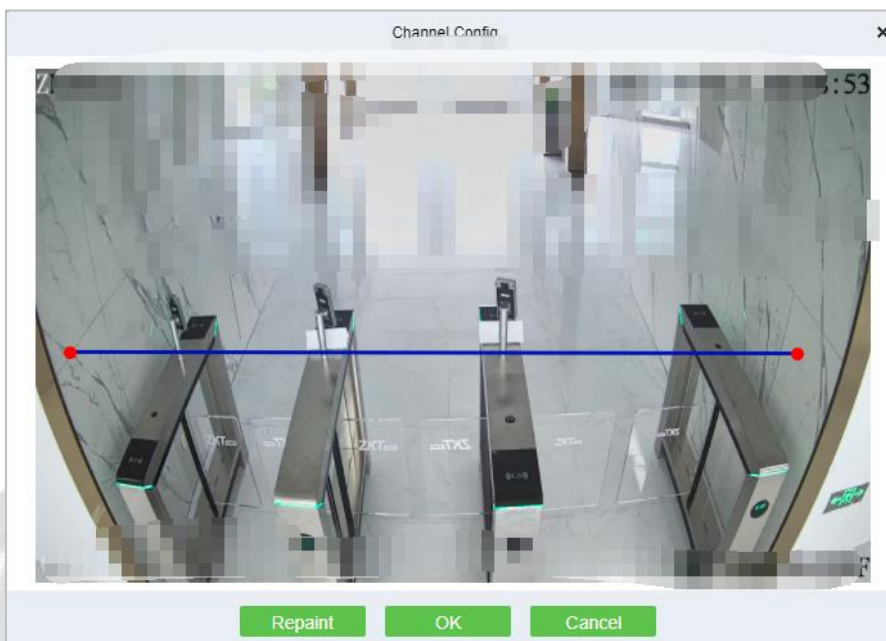

Figure 5- 46 Draw A Line

Result:

Please refer to Perimeter Protection setting, after setting, please go to **Perimeter Protection** to check the dashboard.

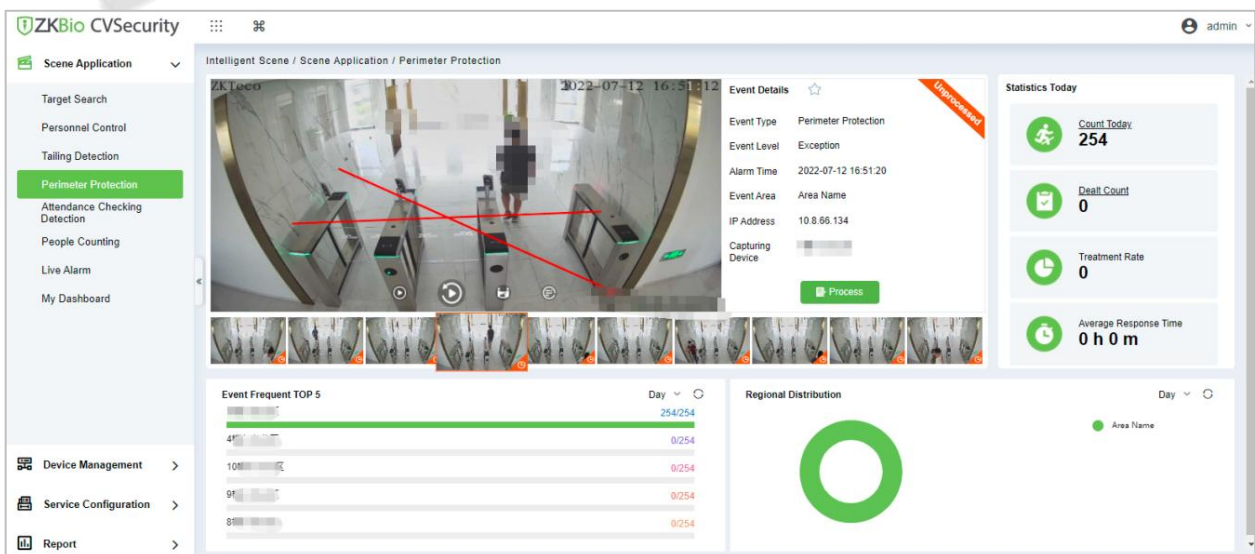

Figure 5- 47 Perimeter Protection Interface

Reboot Device:

It will reboot the selected device.

Synchronize Time:

It will synchronize device time with server's current time.

Synchronize Devices:

Synchronize data of the system to the device. Select device, click **Synchronize Devices** and click **OK** to complete synchronization.

Note: Synchronize Devices will delete all data in the device first (except transactions), and thus download all settings again. Please keep the internet connection stable and avoid power down situations. If the device is working normally, please use this function with caution. Execute it in rare user situations to avoid impact on normal use of the device.

Delete All Faces:

This option will help you to delete all recorded faces.

5.3 Service Configuration

5.3.1 Timezone

Operating Steps:

Step 1: In the **Intelligent Analysis** module, select **Service Configuration > Time Zones**.

Step 2: Click the **New** button and set the daily time period in the pop-up time period new function pop-up window, as shown in Figure 5-48.

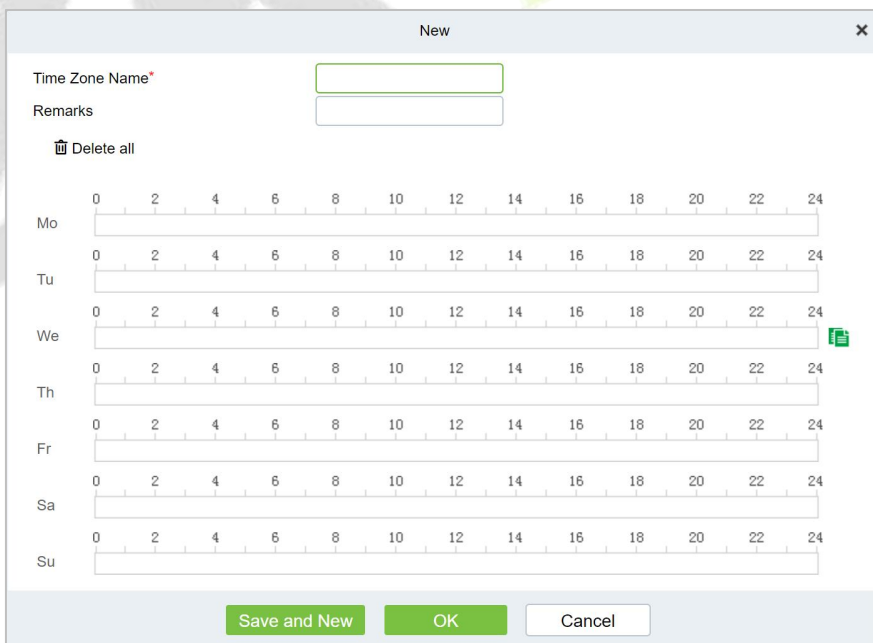

Figure 5- 48 Time Period Configuration

Step 3: Click **OK** to save the settings.

5.3.1.1 Delete

In the **Intelligent Analysis > Service Configuration > Time zone**, select the time zone to be deleted and click **Delete or Delete icon** button under Operations. Click **OK** to delete.

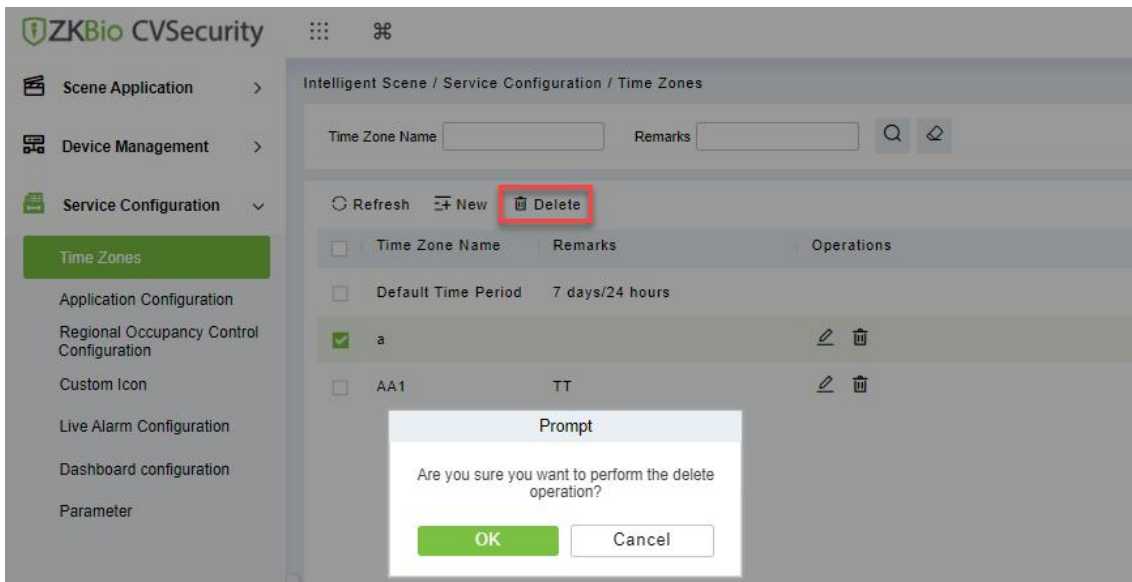

Figure 5- 49 Delete Time Zone

5.3.2 Application Configuration

Operating Steps:

Step 1: In the **Intelligent Analysis** module, select **Service Configuration > Application Configuration**.

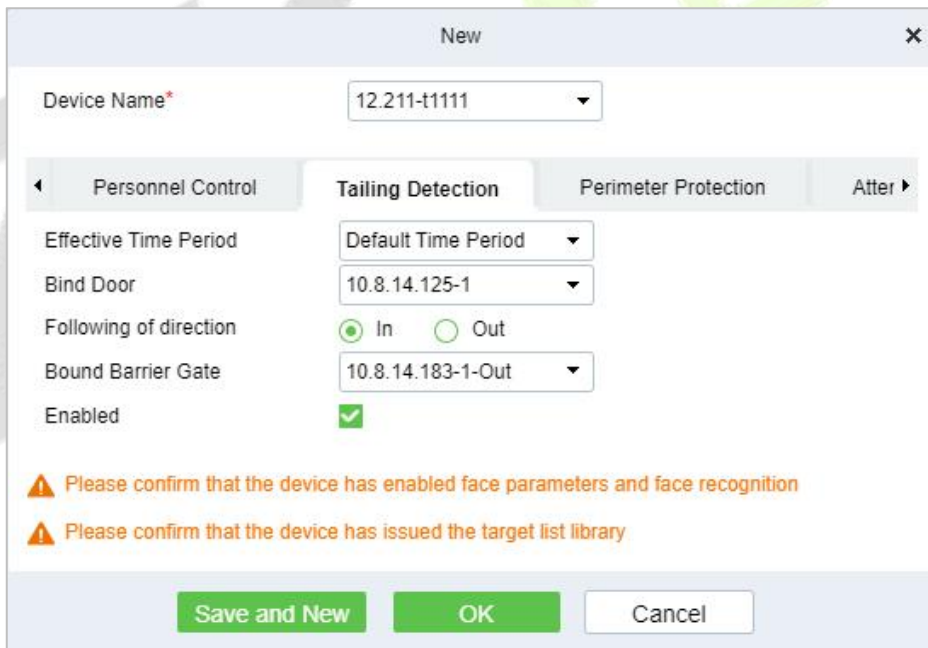

Figure 5- 50 New Tailing Detection Settings

Parameters	Parameter Description
Device Name	Select the camera to set the Tailing Detection function.
Effective Time Period	Set the effective time period of the Tailing Detection function, and the time period list can refer to the content in "16.4 Pre-settings".
Binding Door	Binding Door Select the door information bound to the camera with the Tailing Detection function.
Monitoring	Set the direction of entrance and exit to be monitored.

Direction	
Binding Channel	Select the channel information that the Tailing Detection function is bound to the camera.
Enable	The Tailing Detection settings enable switch.

Table 5- 8 Description of Tailing Detection Parameters

Step 2: Click **OK** to save the settings.

5.3.2.1 Delete

In the **Intelligent Analysis > Service Configuration > Application Configuration**, select the Device to be deleted and click **Delete** or **Delete icon** button under Operations. Click **OK** to delete.

5.3.3 Regional Occupancy Control Configuration

Operating Steps:

Step 1: Access the camera background, and set the line statistics to draw lines.

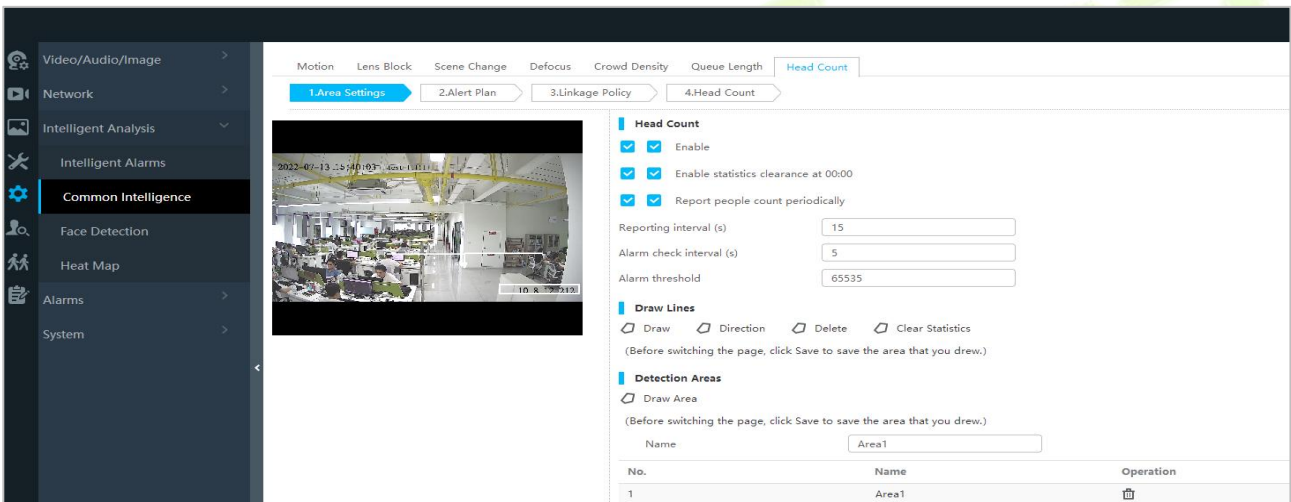

Figure 5- 51 Enable Head Count

Step 2: In the **Intelligent Analysis** module, choose **Service configuration > Regional Occupancy Control Configuration**.

Step 3: Click the **New** button to set the parameters of the statistical range of the number of people, as shown in Figure 5-52. For parameter descriptions, please refer to Table 5-9.

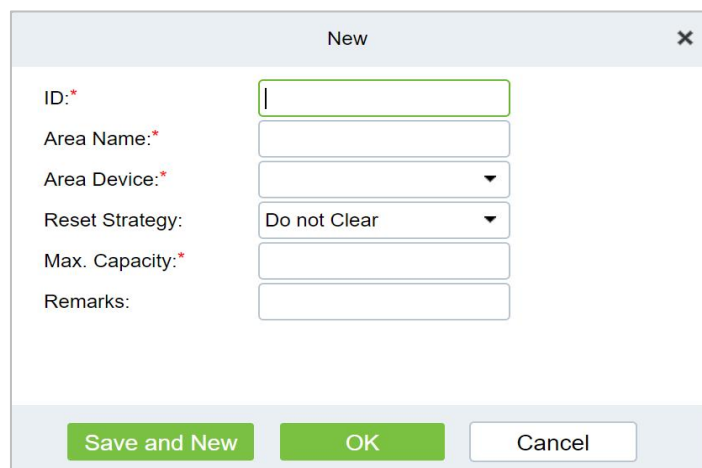

Figure 5- 52 Added Parameter Interface for Statistical Range

Parameter	Parameter description
ID	Custom statistics range number.
Area name	User-defined the area name.
Area device	Select the device which is used to people counting.
Reset strategy	Data statistics automatic clearing strategy setting, providing options of "no clearing" and "clearing at 00:00".
Maximum Capacity	The maximum number of personnel allowed in the custom statistics area.
Remarks	Customize the note information.

Table 5- 9 Description of New Parameters in Statistical Range

Step 4: Click **OK** to save the settings.

5.3.3.1 Delete

In the **Intelligent Analysits > Service Configuration > Regional Occupancy Control Configuration**, select the region to be deleted and click **Delete** or **Delete icon** button under Operations. Click **OK** to delete.

5.3.4 Live Alarm Configuration

Alarm events generated by all devices in the **Intelligent Analysits** Module

Step 1: In the **Intelligent Analysits** module, select **Service Configuration > Live Alarm Configuration**.

Step 2: Click the **New** button and set the live alarm in the pop-up alarm new function pop-up window.

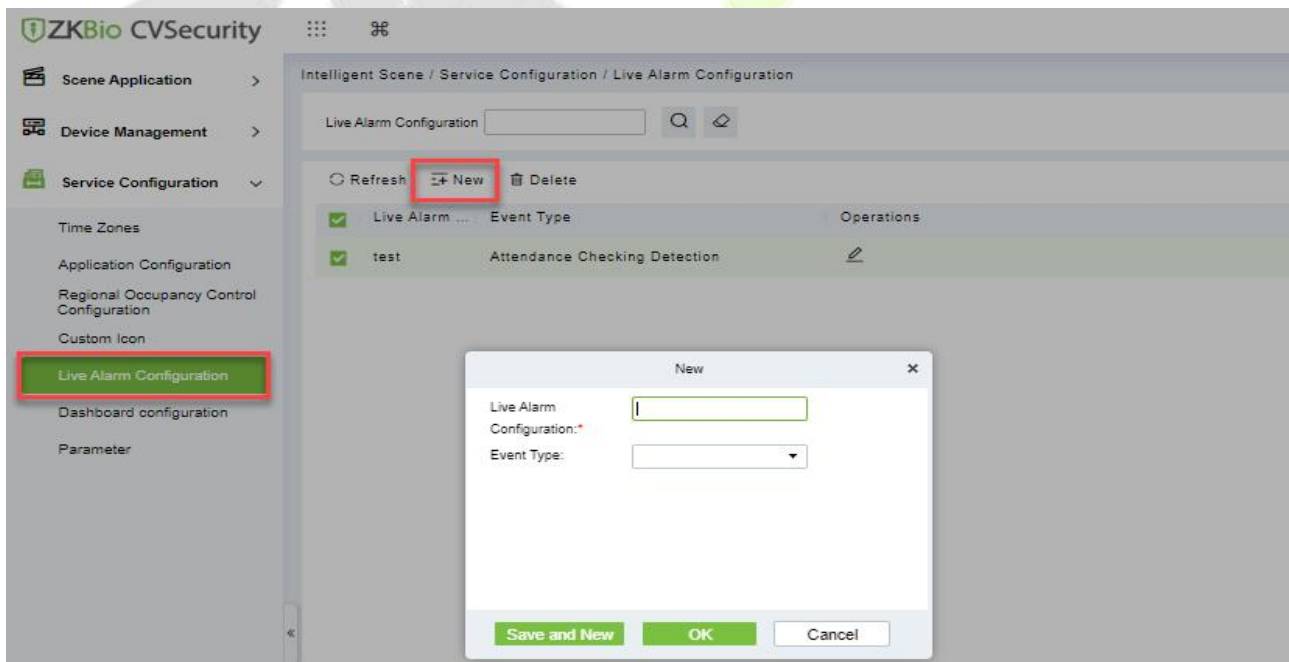

Figure 5- 53 Add Live Alarm Configuration

Parameter	Parameter Description
Configuration Name	User-defined the dashboard name.
Live Alarm	Enter the live alarm name
Event Type	Enter the event type

Table 5- 10 Parameter Live Alarm Configuration

5.3.4.1 Delete

In the **Intelligent Analysis > Service Configuration > Live Alarm Configuration**, select the Live alarm and click **Delete or Delete icon** button under Operations. Click **OK** to delete.

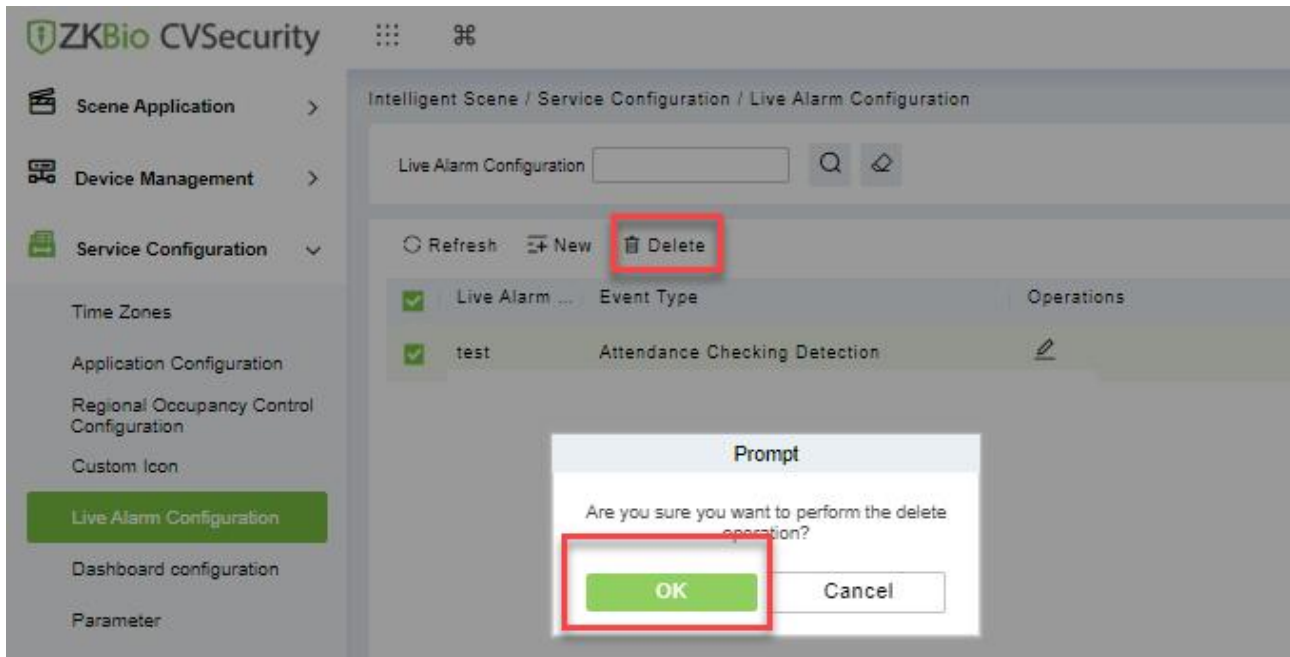

Figure 5- 54 Delete Live Alarm Configuration

5.3.5 Custom Icon

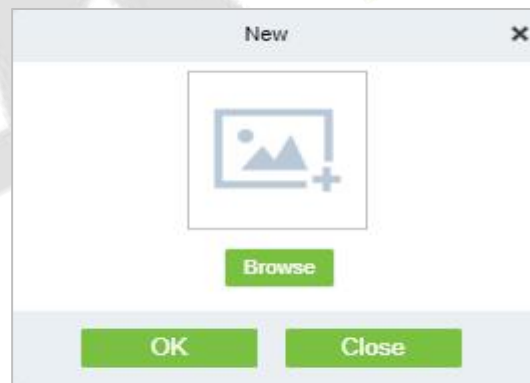

Figure 5- 55 New Custom Icon

5.3.6 Dashboard Configuration

Users can customize the personal data dashboard according to conditions.

Operation Guide:

Step 1: Go to **Intelligent Analysis > Service Configuration > Dashboard Configuration**.

Step 2: Click **New** Button, according to the condition to set the dashboard, as shown in Figure 5-56. For parameter descriptions, please refer to Table 5-11.

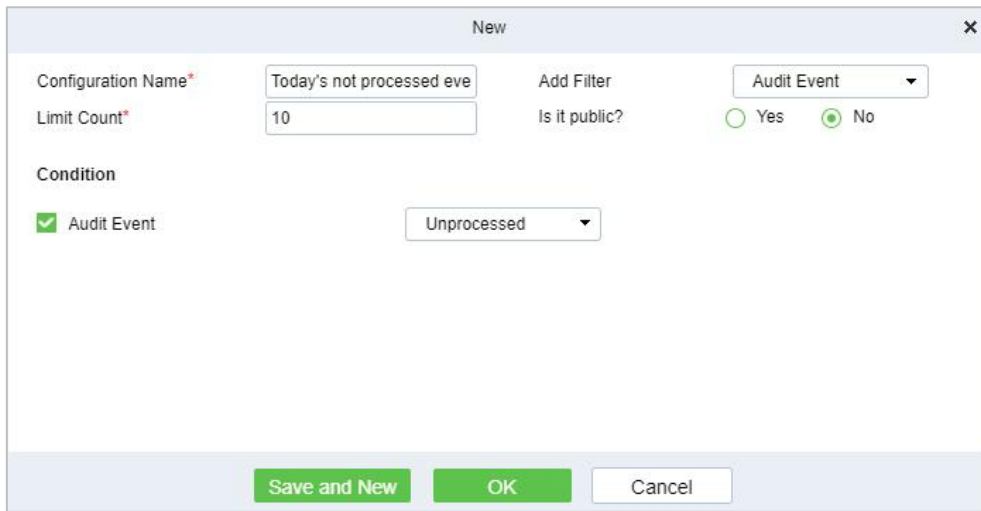

Figure 5- 56 New My Dashboard

Parameter	Parameter Description
Configuration Name	User-defined the dashboard name.
Add Filter	According to your dashboard to add the filter events
Limit Count	The number that needs to be displayed
Is it public?	Is it an individual view or can be seen by everyone
Condition	Configure the condition according to the filter

Table 5- 11 Parameter Dashboard

5.3.6.1 Delete

In the **Intelligent Analysis > Service Configuration > Dashboard Configuration**, select the dashboard name and click **Delete** or **Delete icon** button under Operations. Click **OK** to delete.

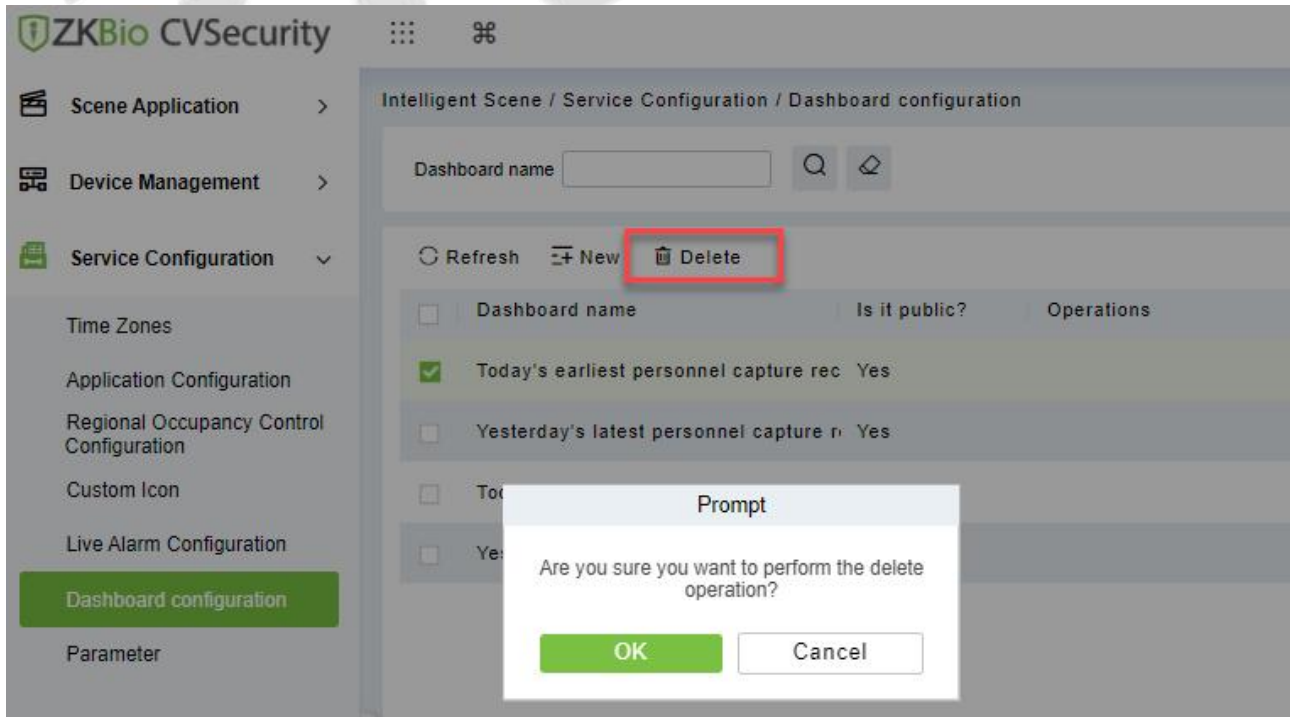

Figure 5- 57 Delete Dashboard Configuration

5.3.7 Parameters

Step 1: Go to **Intelligent Analysits >Service Configuration >Parameter.**

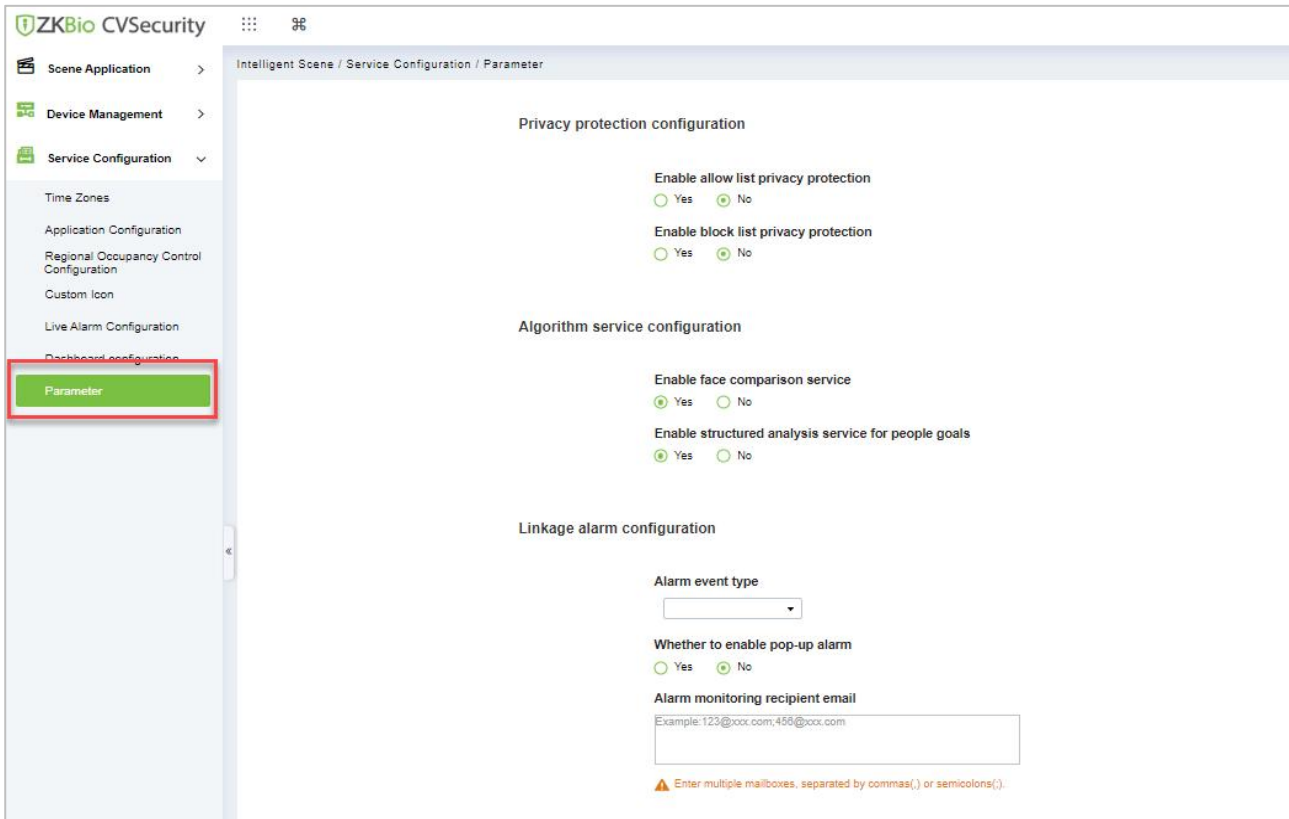

Figure 5- 58 Parameters

5.3.7.1 Privacy protection configuration

Enable the privacy protection list for Allow list and Block List

5.3.7.2 Algorithm configuration

Enable the algorithm service configuration for face comparison and structured analysis for people goals

5.3.7.3 Linkage alarm configuration

If alarm event occurs on this door, whether there will be alarm sound reminder for vehicle detection
When any Linkage is happening, whom to notify via email.

5.4 Reports

5.4.1 All Records

Step 1: Go to **Intelligent Analysis > Reports > All Records**.

Step 2: We can check all the records as a list or images format.

Step 3: On the All Records screen, click Export, enter the user password in the displayed security verification dialog box, and Click **OK**. Select whether to encrypt the file and the file format to export and Click **OK**.

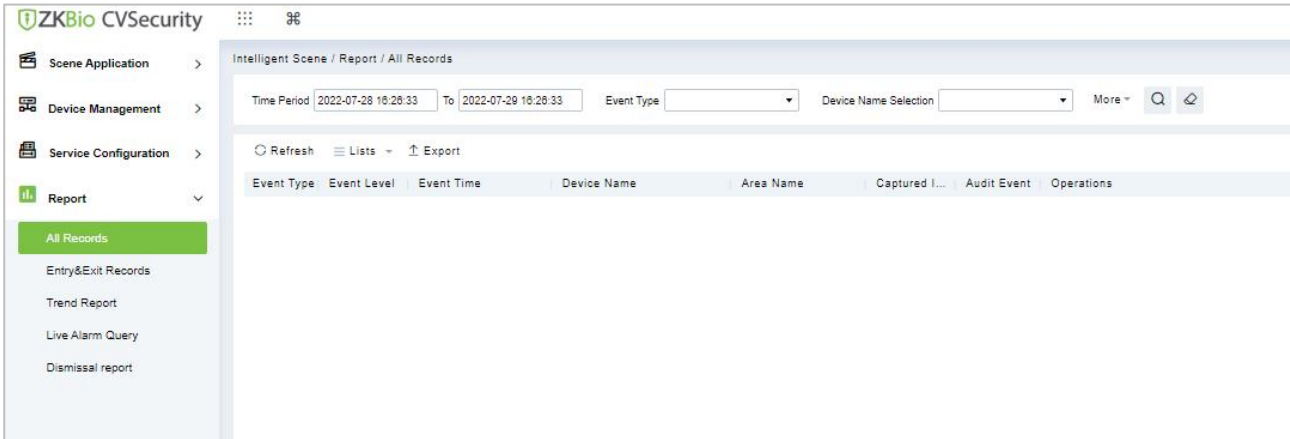

Figure 5- 59 All Records

5.4.2 Entry & Exit Records

Step 1: Go to **Intelligent Analysis > Reports > Entry & Exit Records**.

Step 2: We can check all the records of entry and exit as a list format.

Step 3: On the All Records screen, click Export, enter the user password in the displayed security verification dialog box, and Click **OK**. Select whether to encrypt the file and the file format to export and Click **OK**.

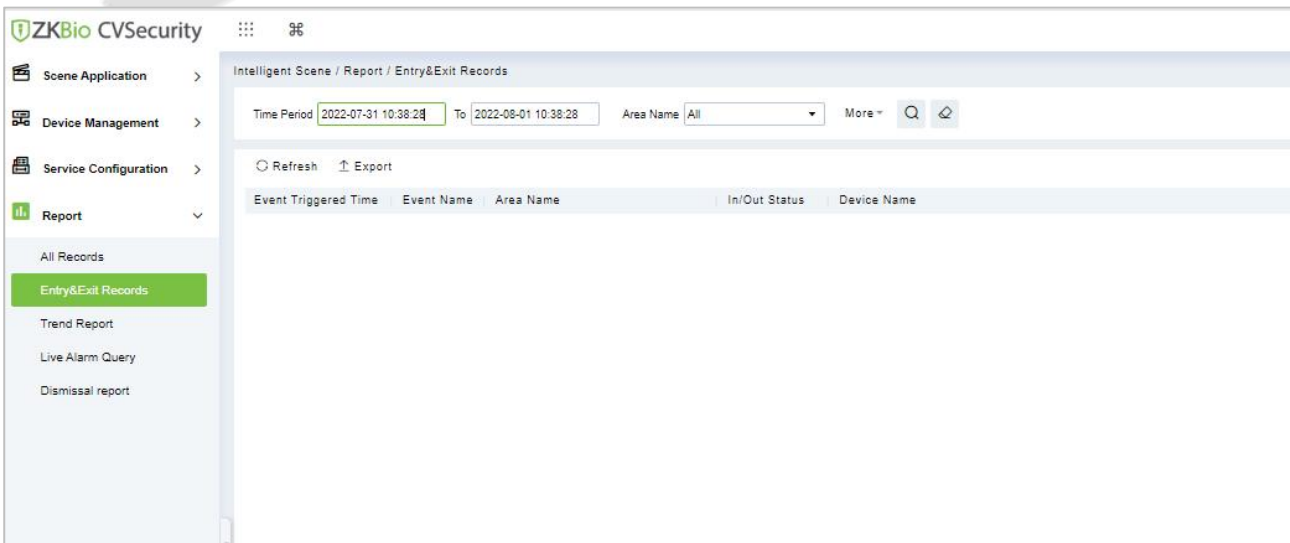

Figure 5- 60 Entry and Exit Records

5.4.3 Trend Reports

Step 1: Go to **Intelligent Analysis > Reports > Trend Records**.

Step 2: We can check all the records of trend as a list format.

Step 3: Click **Delete** button under Operations. Click **OK** to delete.

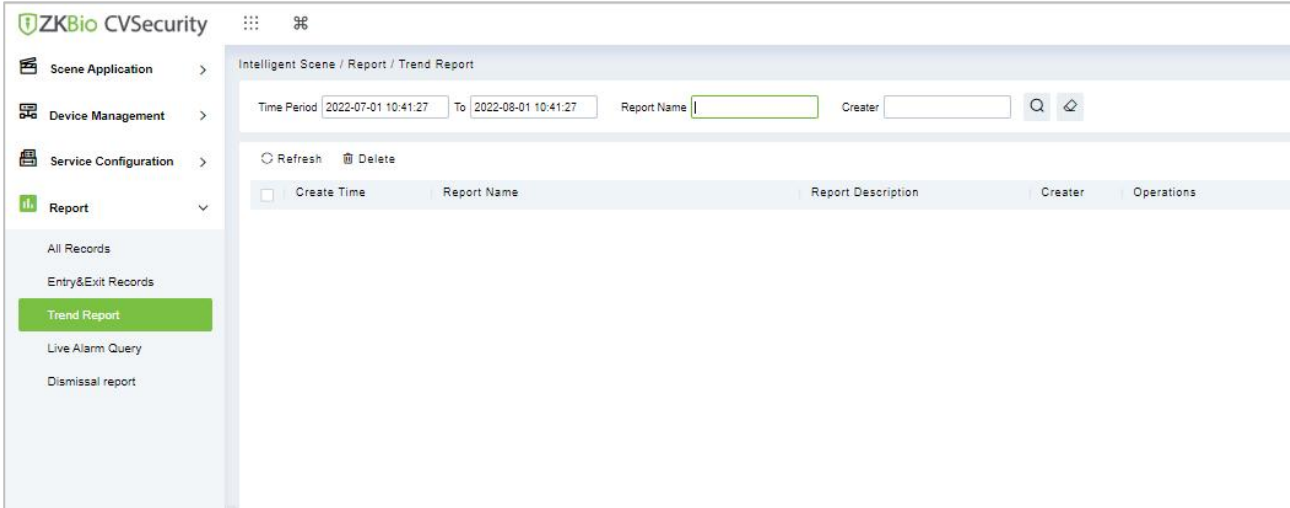

Figure 5- 61 Trends Records

5.4.4 Live Alarm Query

Step 1: Go to **Intelligent Analysis > Reports > Live Alarm Query**.

Step 2: We can check all the records of live alarm query as a list format.

Step 3: On the All Records screen, click **Export**, enter the user password in the displayed security verification dialog box, and Click **OK**. Select whether to encrypt the file and the file format to export and Click **OK**.

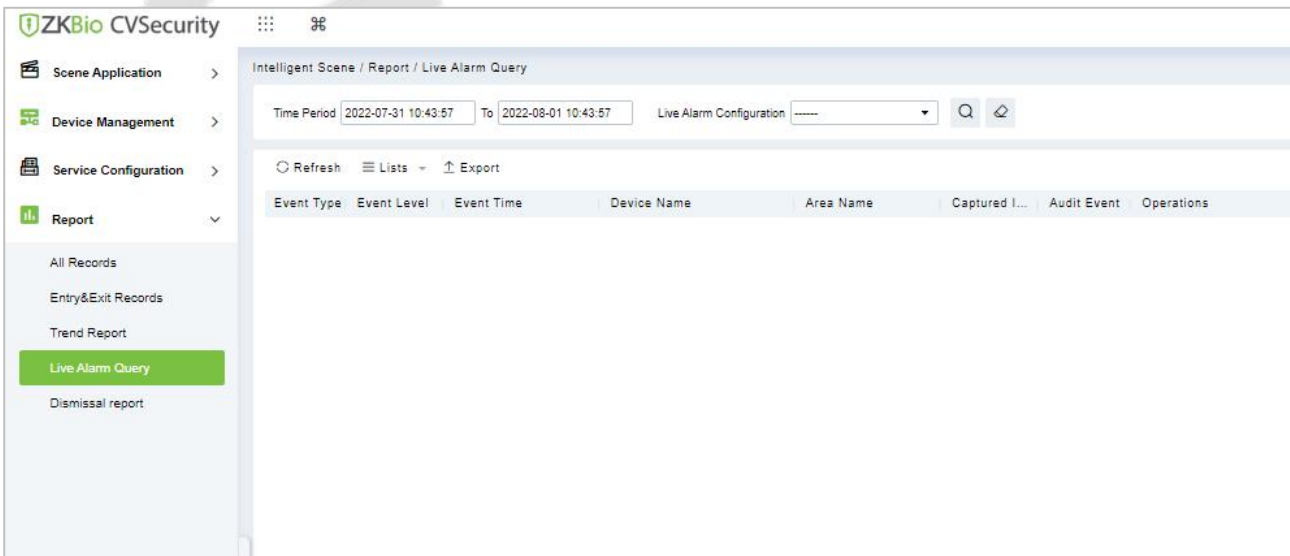

Figure 5- 62 Live Alarm Query

5.4.5 Dismissal Report

Step 1: Go to **Intelligent Analysis > Reports > Dismissal Records**.

Step 2: We can check all the records of dismissal as a list format.

Step 3: Click **Delete** button under Operations. Click **OK** to delete.

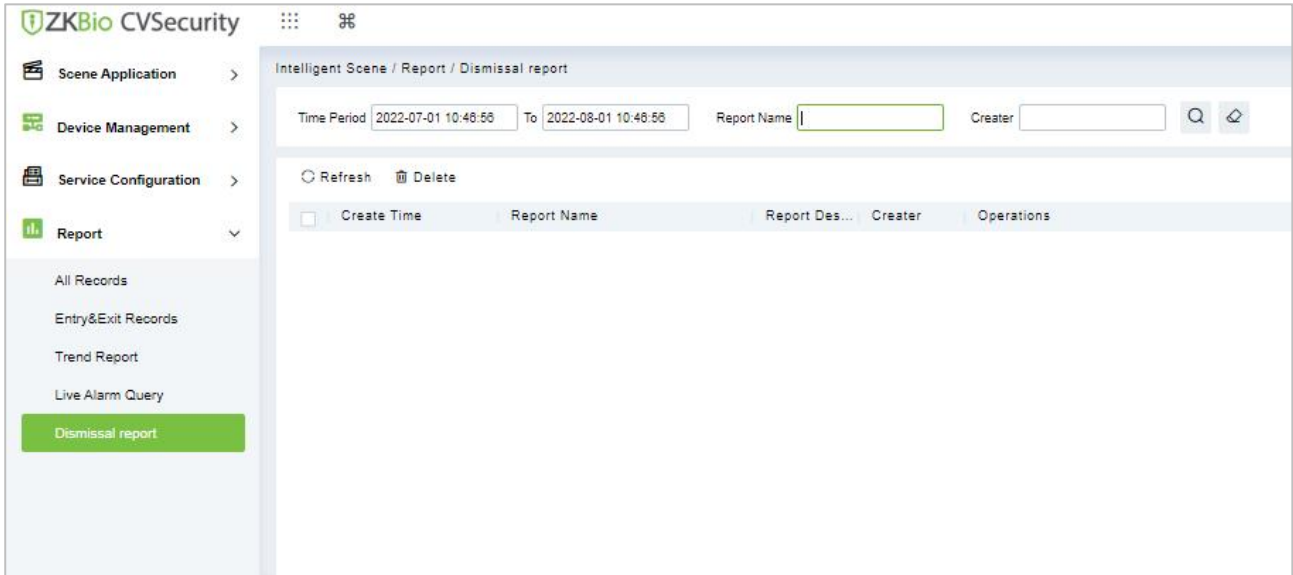

Figure 5- 63 Dismissal Report

6 Attendance Management

6.1 Operation Scenario

Attendance, also known as time management, carries out attendance function operations such as scheduling for employees, and helps enterprises effectively collect attendance data of employees, enter abnormal attendance data, and calculate attendance results.

6.2 Operation Flow

Introduce the configuration process of attendance management business.

The attendance management business configuration process is shown in Figure 6-1.

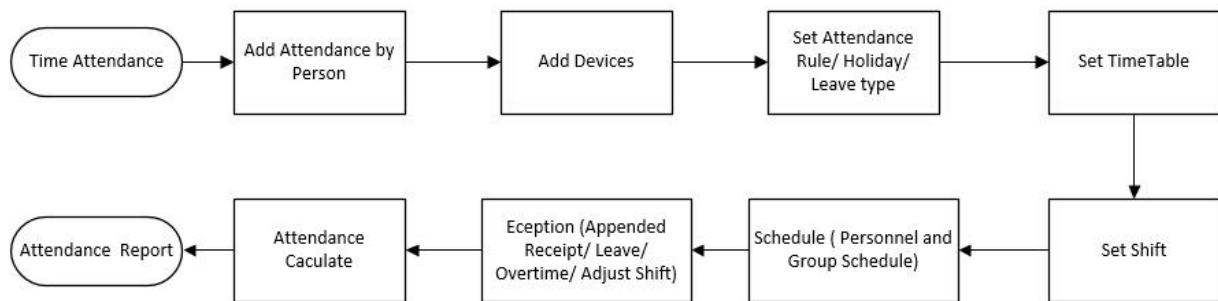

Figure 6- 1 Attendance Configuration Process

6.3 Attendance Management

6.3.1 By Area

This action is used to define which persons in the Attendance area can be attended. Only those who are added to the area can be attended.

This paper introduces the configuration Steps of manually setting regional attendance personnel in.

6.3.1.1 Add Area Personnel

Operating Steps:

Step 1: In **Attendance** module, select "Attendance Management > Setting Personnel by Region", select the region to be set in the list on the left, and then click "Add Regional Personnel" on the right.

Step 2: Add personnel information in the pop-up Add Personnel window, as shown in Figure 6-2.

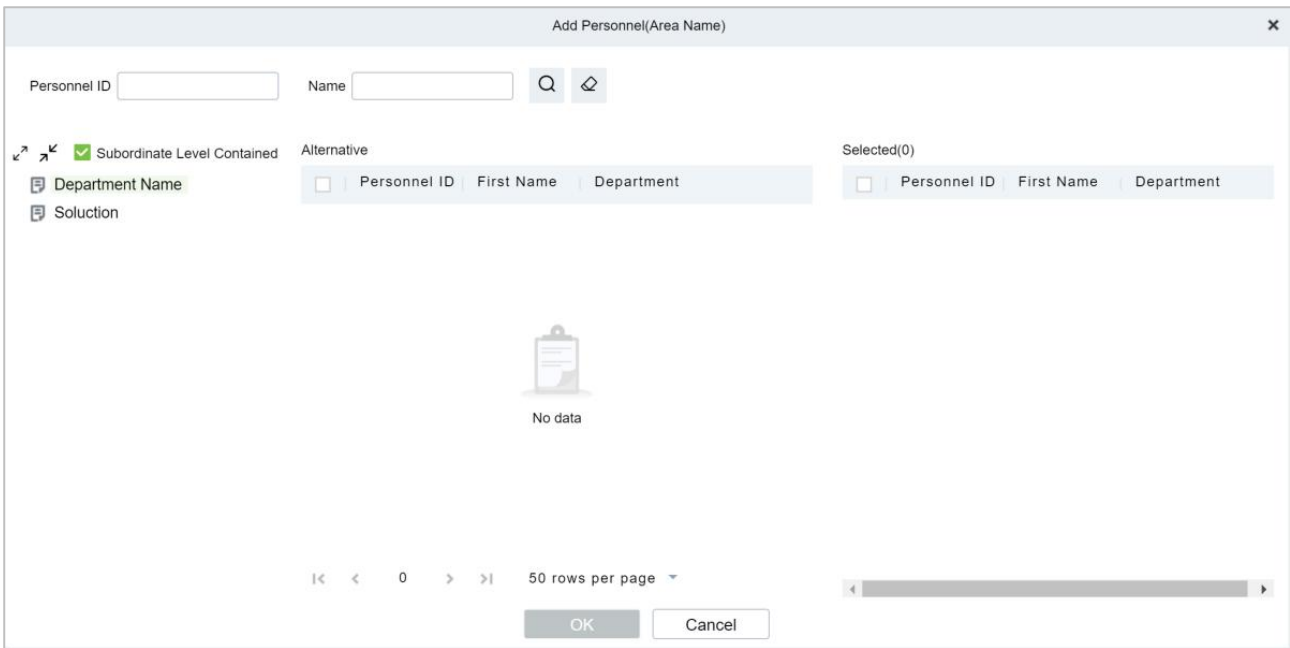

Figure 6- 2 Add by Area

Step 3: Click **OK** to complete the configuration of adding attendance personnel in the area.

6.3.1.2 Delete Area Personnel

Step 1: On the **Area** interface, select the required ID from the list.

Step 2: Click **Delete** or click on the  icon to delete the selected ID.

Step 3: Click **Delete**, to ensure and delete the selected ID from the list.

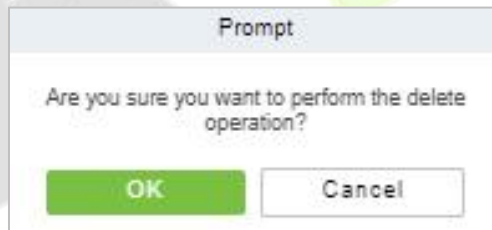

Figure 6- 3 Deleting People

6.3.1.3 Export

You can export all transactions in Excel, PDF, CSV format.

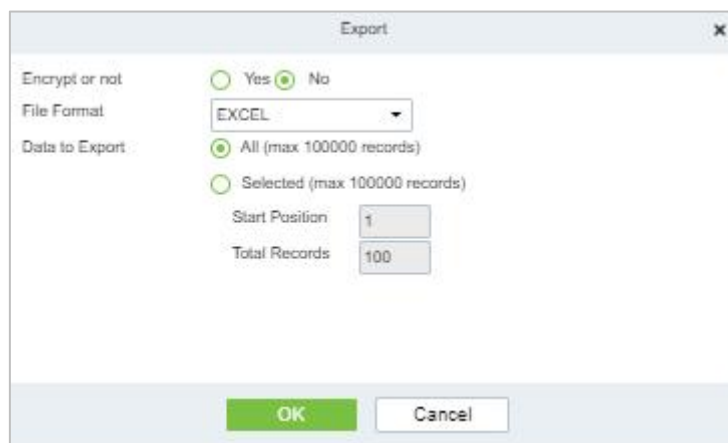

Figure 6- 4 Export People

6.3.1.4 Import

You can import all transactions in Excel, PDF, CSV format.

Import Area Personnel:

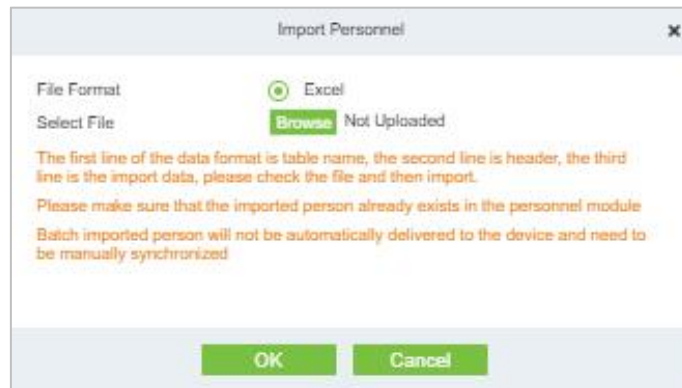

Figure 6- 5 Adding People Import Area

Import and Delete Area Personnel:

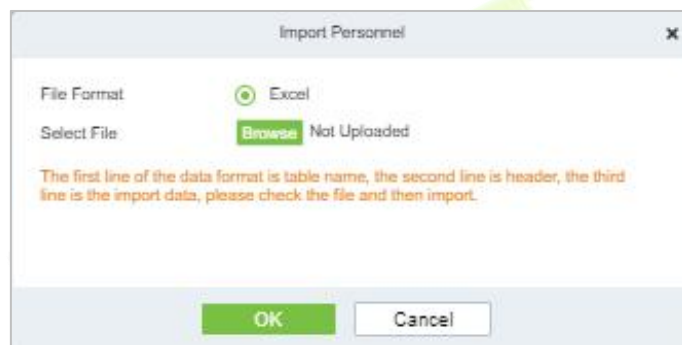

Figure 6- 6 Import Personnel

Download Import Template:

You can download the entire file in Excel, PDF, CSV format.

6.3.1.5 Private Message

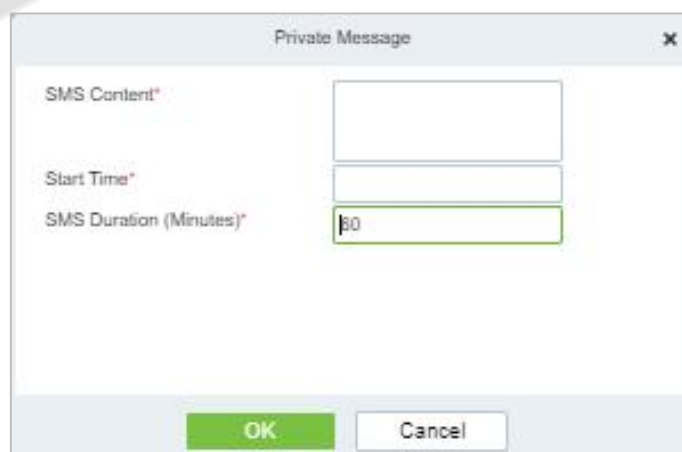

Figure 6- 7 Private Message

6.3.2 Attendance Device Description (Attendance Device)

This paper introduces adding attendance device and setting communication parameters of connecting device, including the settings in the system and attendance device. After successful communication, you can view the information of connected devices, monitor the machines remotely, synchronize data and other operations.

Use Attendance Machine as Attendance Data Source

Precondition:

You need to set up the communication of the device first:

1. Open "**Communication Settings > Network Settings**" on the attendance device and configure the device network information in the pop-up "Network Settings" window.
2. Open "**Communication Settings > Cloud Service Settings**" and configure cloud server information in the pop-up "Cloud Server Settings" window.

6.3.2.1 Authorized Device

This paper introduces the configuration Steps of adding attendance device in by authorization.

Operating Steps:

Step 1: In the **Attendance** module, select **Attendance Management > Attendance Device**, and click "Authorized device".

Step 2: In the **Authorized Devices** window that pops up, add attendance devices, as shown in Figure 6-8.

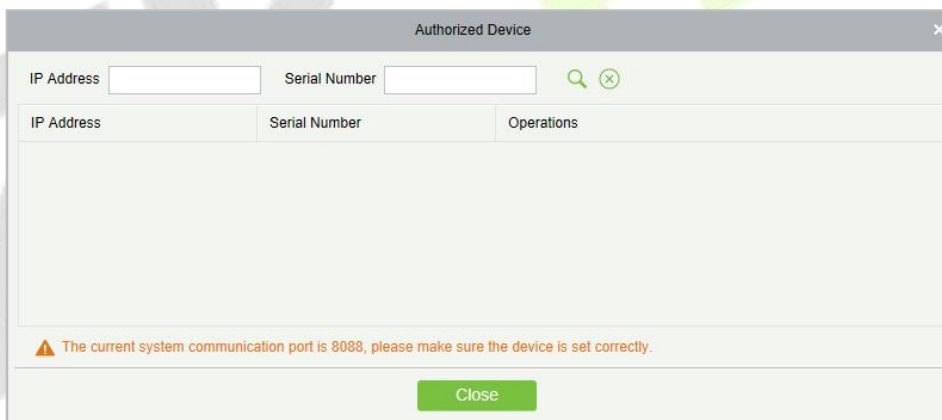

Figure 6- 8 Device Authorization Add Interface

Step 3: In the **Add** window that pops up, configure the device information, as shown in Figure 6-9, and the key parameters are described in Table 6-1.



Figure 6- 9 Adding Device Setup Interface

Parameter	Description
Attendance Area	The device is divided into regions to realize the management of regional data.
Whether To Register the Machine	If it is not checked, the user data uploaded by the device will not be processed (if the attendance record of the device is checked or not, it will be processed); Check, and the user data uploaded by the device will be processed.

Table 6- 1 Description of Key Parameters.

6.3.2.2 Delete

Step 1: On the **Device** interface, select the required Device Name from the list.

Step 2: Click **Delete** or click on the  icon to delete the selected Device.

Step 3: Click **Delete**, to ensure and delete the selected Device from the list.

6.3.2.3 Device Control

● Upgrade Firmware

Tick the device that needs to be upgraded, click **Upgrade firmware** to enter edit interface, then click **Browse** to select firmware upgrade file (named emfw.cfg) provided by Access software, and click **OK** to start upgrading.

Note: The user shall not upgrade firmware without authorization. Contact the distributor before upgrading firmware or upgrade it following the instructions of the distributor. Unauthorized upgrade may affect normal operations.

● Reboot Device

It will reboot the selected device.

● Public Message

You can set public message in the device so that the device can display short messages on the page (Not all the devices support this function).

● Disable/Enable

Select device, click **Disable/Enable** to stop/start using the device. When communication between the device and the system is interrupted or device fails, the device may automatically appear in disabled status. After adjusting local network or device, click **Enable** to reconnect the device and restore device communication.

● Synchronize Software Data to Devices

Synchronize data of the system to the device. Select device, click **Synchronize All Data to Devices** and click **OK** to complete synchronization.

● Authorize Area

It can reach certain areas within a period of time after being authenticated.

6.3.2.4 View and Get Information

● Get Device Option

It gets the common parameters of the device. For example, get the firmware version after the device is updated.

● Get the specified personnel data

Renew the current number of personnel, fingerprints, finger vein and face templates in the device. The final value will be displayed in the device list.

- **Attendance Data Checking**

Select the device to proofread data, select the proofing date, the software issues a command to proofread the software and device attendance data.

- **Re-Upload Data**

To re-upload the data from the device.

- **View Device Parameters**

To view the parameters and the specification of the device.

6.3.2.5 Clear Device Data

- **Clear unexecuted device commands**

Select the device to be cleared. It clears the unexecuted operation command issued by the software in the setting.

- **Clear the attendance photos**

This function will clear all the attendance photo records from the device.

- **Clear the attendance transactions**

Select the device. This function will clear all the attendance data records from the device.

- **Clear equipment personnel**

This function will clear all the equipment personnel records from the device.

6.3.3 Attendance Point

This paper introduces the configuration Steps of using **Access Control** machine as attendance data source in.

6.3.3.1 New

Operating Steps:

Step 1: In the **Attendance** module, select **Attendance Management > Attendance Points**, and click **New**.

Step 2: Add **Access Control** attendance points in the pop-up **Add** window, as shown in Figure 6-10. Please refer to Table 6-2 for explanations of key parameters.

Figure 6- 10 Adding Attendance Point Interface

Parameter	Description
Device Module	Device module for setting attendance record source.
Area Name	The area to which the device belongs.
Door List	You need to set the door corresponding to the attendance record source.

Table 6- 2 Parameter Description

Step 3: Click **OK**.

Step 4: Select "**Detailed Report > Original Record Table**" and click **Synchronous Attendance Point Record**.

Step 5: Select the time node and attendance point to be synchronized in the pop-up **Synchronize Attendance Point Record** window, as shown in Figure 6-11.

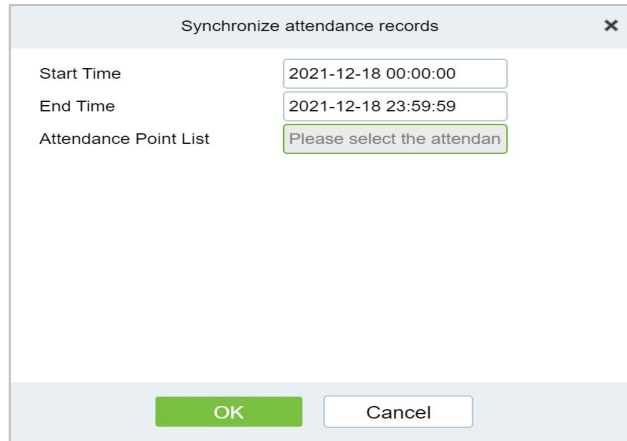

Figure 6- 11 Record of Synchronized Attendance Points

Step 6: Click **OK**.

6.3.3.2 Export

You can export all transactions in Excel, PDF, CSV format.

6.3.3.3 Delete

Step 1: On the **Attendance Point** interface, select the required Attendance Point Name from the list.

Step 2: Click **Delete** or click on the  icon to delete the selected Attendance Point.

Step 3: Click **Delete**, to ensure and delete the selected Attendance Point from the list.

6.3.4 Roll Call

The procedure of identifying the availability by calling out a list of names

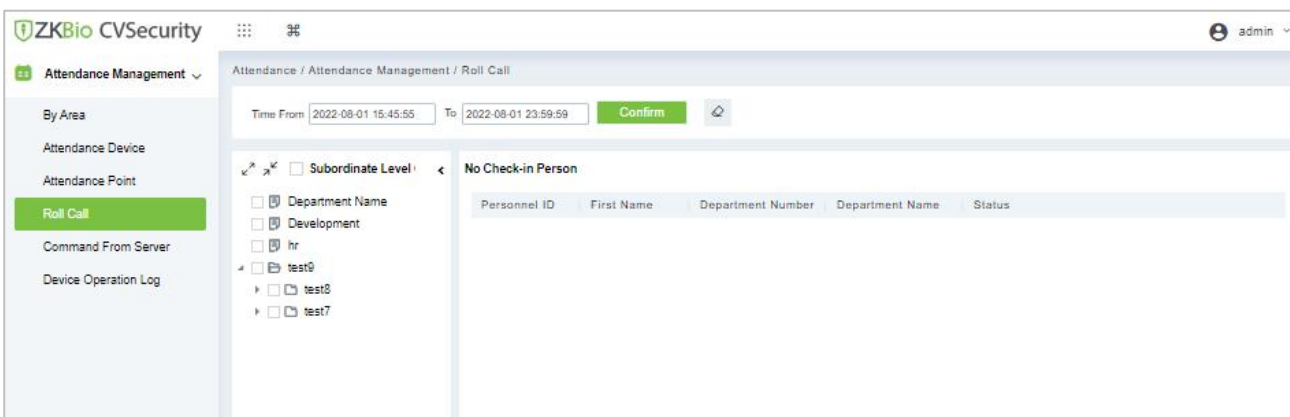

Figure 6- 12 Roll Call

6.3.5 Command from Server

6.3.5.1 Clear Command List

Step 1: You can clear command as required. Click **Clear Command** after selecting the corresponding ID.

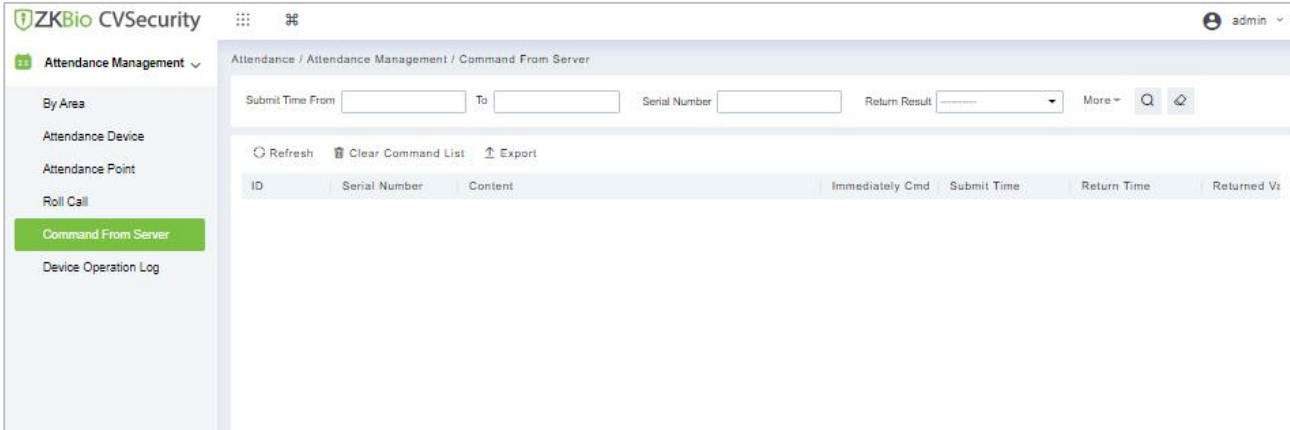

Figure 6- 13 Roll Call Clear Command List

6.3.5.2 Export

You can export all transactions in Excel, PDF, CSV format.

6.3.6 Device Operation Log

For communication between the system and device, data uploading, configuration downloading, device and system parameters shall be set. Users can edit access controllers within relevant levels in the current system; users can only add or delete devices in Device Management if needed.

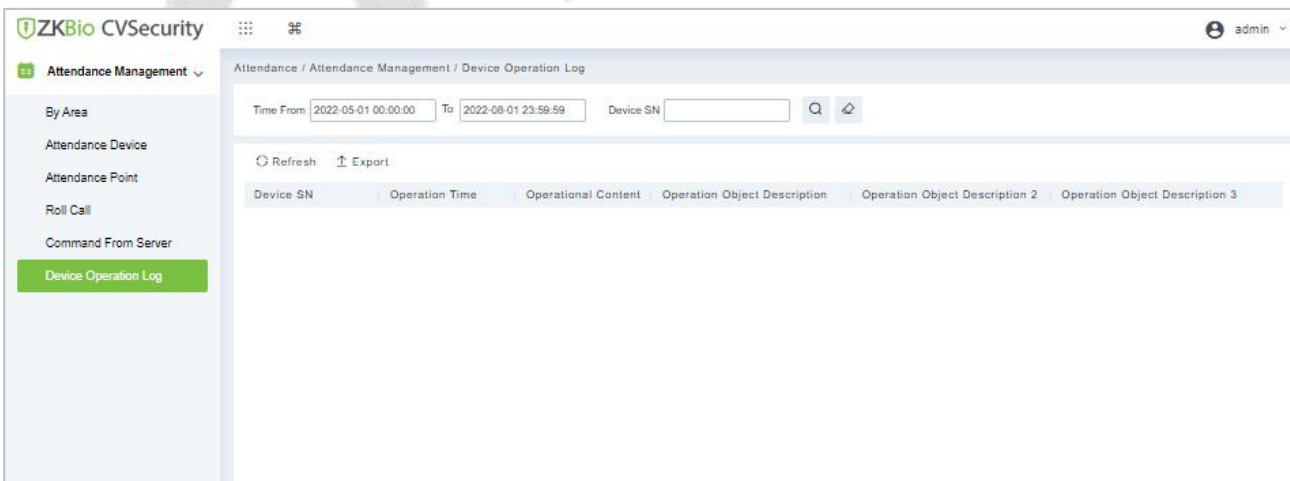

Figure 6- 14 Device operation Log

6.3.6.1 Export

You can export all transactions in Excel, PDF, CSV format.

6.4 Attendance Setting

Attendance settings affect attendance results, is the core of attendance calculation logic, including attendance rules settings, holiday settings, fake settings.

6.4.1 Attendance Rule Setting

Because the attendance system is different in each company, it is necessary to manually set attendance rules to ensure the accuracy of the final attendance calculation. The setting of attendance rules is the main way to reflect the attendance system of enterprises.

This paper introduces the configuration Steps of attendance rules in.

6.4.1.1 Basic Rule Setting

Operating Steps:

Step 1: In the Attendance module, select Attendance Settings > Attendance Rules.

Step 2: In the Attendance Rule interface, fill in the attendance rules as required, as shown in Figure 6-15, and the basic rule parameter description is shown in Table 6-3.

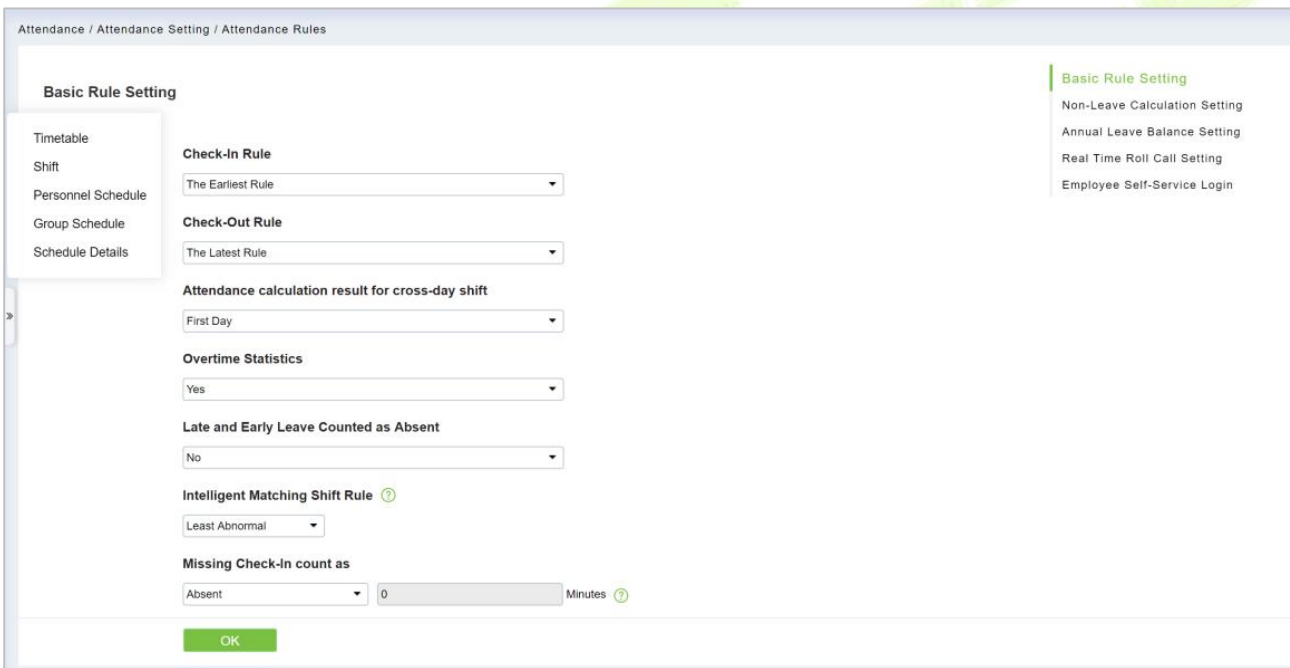

Figure 6- 15 Attendance Rules

6.4.1.2 Non-Leave Calculation Setting

Operating Steps:

Step 1: In the Attendance module, select Attendance Settings > Attendance Rules>Non-Leave Calculation Setting.

Step 2: In the Attendance Rule interface, fill in the attendance rules as required, as shown in Figure 6-16, and the Non-Leave Calculation description is shown in Table 6-3.

The screenshot shows the 'Non-Leave Calculation Setting' window. It features a scrollable list of categories: No Check-In, Overtime, Not Scheduled, Adjust Shift, Rest Day, Adjust Rest, and Holiday. Below the list are four input fields: 'Minimum Unit*' with a value of '1' and a unit of 'minute'; 'Rounding Control*' set to 'Up (Carry)'; and 'Report Display Symbol*' with a square root symbol.

Figure 6- 16 Attendance Rules Settings

6.4.1.3 Annual Leave Balance Setting

Operating Steps:

Step 1: In the Attendance module, select Attendance Settings > Attendance Rules>Annual Leave Balance Setting.

Step 2: In the Attendance Rule interface, fill in the attendance rules as required, as shown in Figure 6-17, and the Annual Leave Balance description is shown in Table 6-3.

The screenshot shows the 'Annual Leave Balance Setting' window. It contains two warning messages: one about setting the hire date for the annual leave balance table, and another about the clearing issue date. Below the warnings are three sections: 'Annual Leave Clearing and Issuing Date' with dropdowns for 'Every year' (1), 'Month' (1), and 'Day'; 'Calculate According to Work Time Ratio' with radio buttons for 'Down (Discard)', 'rounding' (selected), and 'Up (Carry)'; and 'Annual Leave Rule' with a table of rules. The table has three rows: 'Working Years ≤ 1' with 1 year and 1 day of leave; '1 Year Working Years ≤' with 2 years and 5 days of leave; and 'Working Years >' with 2 years and 5 days of leave.

Figure 6- 17 Annual Leave balance Setting

6.4.1.4 Real Time Roll Call Setting

Operating Steps:

Step 1: In the Attendance module, select **Attendance Settings > Attendance Rules>Real Time Roll Call Setting**.

Step 2: In the Attendance Rule interface, fill in the attendance rules as required, as shown in Figure 6-18, and the Real Time Roll Call description is shown in Table 6-3.



Figure 6- 18 Roll Call Real Time

6.4.1.5 Employee Self-Service Login

Operating Steps:

Step 1: In the Attendance module, select Attendance Settings > Attendance Rules>Employee Self Service Login Setting.

Step 2: In the Attendance Rule interface, fill in the attendance rules as required, as shown in Figure 6-16.2, and the Employee Self Service Login description is shown in Table 6-3.



Figure 6- 19 Roll Call Real Time

Parameter	Specific Parameters	Description
Basic Rule	Work check-in and card collection rules	<ul style="list-style-type: none"> The earliest (by default, the first punch-in record is taken within the valid card taking range) Nearby (take the clock-in record closest to working hours within the valid card-taking range).
	Rules for sign-out and card collection after get off work	<ul style="list-style-type: none"> Latest (by default, the last punch-in record is taken within the valid card taking range) Nearby (take the clock-in record closest to the attendance checking time within the valid card-taking range).
	The shortest attendance period should be greater than (10 minutes)	120 (default); Range: 10 to 999; Required
	The longest attendance period should be less than (1440 minutes)	600 (default); Range: 10 to 1440; Required
	The shift time period spans days, and the attendance calculation results	<ul style="list-style-type: none"> On the first day, if there is a cross-day, count the working hours in the effective shift on the second day to the first day. On the second day, if there is a cross-day, the working

Parameter	Specific Parameters	Description	
		hours in the effective shift on the first day are counted to the second day.	
	Being late and leaving early is absenteeism	<ul style="list-style-type: none"> • No (default) • If yes, there are cases of being late and leaving early, and this period is recorded as absenteeism. 	
	Statistical overtime	<ul style="list-style-type: none"> • Yes (default) • No; If the first switch of overtime statistics is set to No, overtime will not be calculated. 	
	Minimum overtime time per time (minutes)	This parameter is applied to overtime rule duration statistics. If overtime duration is less than the set minimum overtime duration, it will not be reflected in attendance statistics.	
	Exact number of decimal points	1 (default), 2.	
	Failure to sign in is recorded as	Three ways: <ul style="list-style-type: none"> • Absence • Be late • Incomplete Description: <ul style="list-style-type: none"> • When you are late, you should set the number of minutes you are late. • Absence and incompleteness are not valid attendance, but absence is absenteeism and incompleteness is absenteeism. Statistics attendance by setting basic rules in monthly detailed reports and other related reports. 	
	Unsigned refund as	Three ways: <ul style="list-style-type: none"> • Absence • Be late • Incomplete Description <ul style="list-style-type: none"> • When you are late, you should set the number of minutes you are late. • Absence and incompleteness are not valid attendance, but absence is absenteeism and incompleteness is absenteeism. Statistics attendance by setting basic rules in monthly detailed reports and other related reports. 	
Non-Pseudo Class Calculation Settings	Set up various states of non-fake classes (including being late, leaving early, not signing in, etc.)	Minimum unit	Calculate the smallest unit of this arix
		Rounding control	<ul style="list-style-type: none"> • Down (discard): discard the decimal part, as long as the integer. • Rounding: If the first decimal place is greater than 5, the integer will be added with 1, otherwise, the integer will be taken. • Up (carry): With decimal, discard decimal, integer plus 1
		Report presentation symbol	Symbols for associated report presentation

Parameter	Specific Parameters	Description
<p>Setting of Annual Leave Balance</p>	<p>Annual leave cleared and issued date</p>	<p>Set the annual leave clearing date</p>
	<p>Calculated according to the proportion of working hours</p>	<p>There are three ways to calculate the proportional duration:</p> <ul style="list-style-type: none"> • Down (discard): discard the decimal part, as long as the integer. • Rounding: If the first decimal place is greater than 5, the integer will be added with 1, otherwise, the integer will be taken. • Up (carry): With decimal, discard decimal, integer plus 1
	<p>Rules of annual leave duration</p>	<p>Set annual leave days according to length of service, which can be added by symbols</p>
<p>Real-Time RollCall Setting</p>	<p>Turn on the real-time roll call function, and the sign-in status of personnel will be displayed in the "sign-in Table" under the report.</p>	
<p>Employee Self Service Login</p>	<p>The frequency of setting attendance points to obtain records includes (10 seconds/time, 20 seconds/time, 30 seconds/time, 1 minute/time ~ 8 minutes/time).</p>	

Table 6- 3 Description of Basic Rule Parameters

6.4.2 Holidays

This paper introduces the configuration Steps of manually adding holidays in.

6.4.2.1 New

Operating Steps:

Step 1: In the **Attendance** module, select "Attendance Settings > Holidays" and click **New**.

Step 2: Configure holiday information in the pop-up **Add** window.

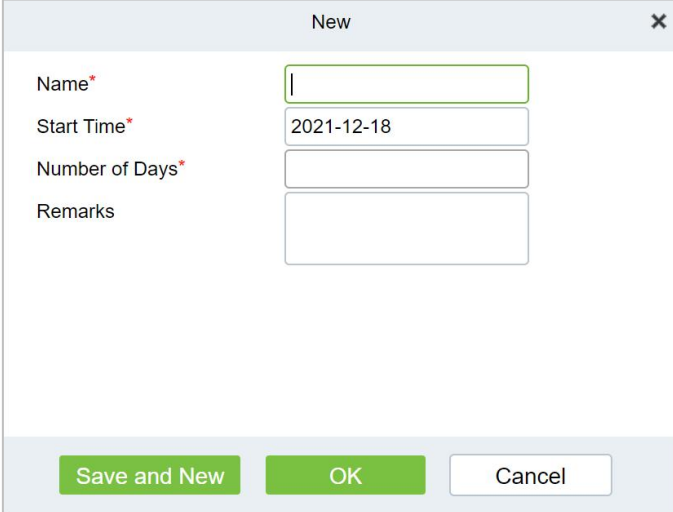

The screenshot shows a 'New' dialog box with the following fields and buttons:

- Name***: Text input field, currently empty.
- Start Time***: Date input field, containing '2021-12-18'.
- Number of Days***: Text input field, currently empty.
- Remarks**: Text area, currently empty.
- Buttons**: 'Save and New' (green), 'OK' (green), and 'Cancel' (white).

Figure 6- 20 New Holidays

Step 3: Click **OK**.

6.4.2.2 Delete

Step 1: On the **Holiday** interface, select the required Holiday Name from the list.

Step 2: Click **Delete** or click on the  icon to delete the selected Holiday list.

Step 3: Click **Delete**, to ensure and delete the selected Holiday from the list.

6.4.3 Leave Type

This paper introduces the configuration Steps of adding Leave Type.

6.4.3.1 New

Operating Steps:

Step 1: In the **Attendance** module, select **Attendance Settings > Leave Type** and click **Add**.

Step 2: Configure fake information in the pop-up **Add** window, as shown in Figure 6-21. Please refer to Table 6-4 for explanations of key parameters.

Figure 6- 21 New Leave Type

Parameter	Description
Name	Character length 30, required.
Whether To Deduct Working Hours	Whether the working hours should be deducted for setting this kind of leave, for example, maternity leave/marriage leave/annual leave are all legal holidays, and the working hours are not deducted.
Minimum Unit	Calculate the smallest unit for this alias.
Rounding Control	Down (discard): discard the decimal part, as long as the integer; Rounding: If the first decimal place is greater than 5, the integer will be added with 1, otherwise, the integer will be taken; Up (carry): There are decimals, decimals are discarded, integers are added by 1.
Report Presentation Symbol	Symbols for the presentation of the associated report.

Table 6- 4 Description of Key Parameters

Step 3: Click **OK**.

6.4.3.2 Delete

Step 1: In the **Leave Type** interface, select the required Leave from the list.

Step 2: Click **Delete** or click on the  icon to delete the required Leave from the list.

Step 3: Click **Delete**, to ensure and delete the selected Leave from the list.

6.4.4 Automatic Report

The Automatic reporting feature helps you to send the reports to the designated person at the specified time.

6.4.4.1 New

Operating Steps:

Step 1: In the **Attendance** module, select **Attendance Settings > Automatic Report** and click **New**.

Step 2: Click to **New** to configure all the details.

Figure 6- 22 Automatic Report

6.4.4.2 Delete

Step 1: In the **Automatic Report** interface, select the required File from the list.

Step 2: Click **Delete** or click on the  icon to delete the required File from the list.

Step 3: Click **Delete**, to ensure and delete the selected File from the list.

6.4.4.3 Enable/Disabled

Select device, click **Disable/Enable** to stop/start using the device. When communication between the device and the system is interrupted or device fails, the device may automatically appear in disabled status. After adjusting local network or device, click **Enable** to reconnect the device and restore device communication.

6.4.5 Process Settings

To achieve the approval function, it is necessary to maintain the relationship between positions at all levels in the personnel module and assign them to the corresponding personnel. Then setup the approval process for different process types and different positions.

6.4.5.1 New

Operating Steps:

Step 1: In the **Attendance** module, select **Attendance Settings > Process Settings** and click **New**.

Step 2: Click to **New** to configure all the details.

The screenshot shows a 'New' dialog box with the following fields and controls:

- Number* (text input)
- Name* (text input)
- Choose position* (dropdown menu)
- Flow Type* (dropdown menu, currently showing 'Appended Log')
- Inform the person (text input) with a 'Clear' button

Below the input fields is a table with the following structure:

The name of the no...	The a...	Position of ...	Inform the person	Operations
Directly under the leac				[Edit] [Delete]

At the bottom of the dialog are three buttons: 'Save and New', 'OK', and 'Cancel'.

Figure 6- 23 Processing Setting

6.4.5.2 Enable/Disabled

Select device, click **Disable/Enable** to stop/start using the device. When communication between the device and the system is interrupted or device fails, the device may automatically appear in disabled status. After adjusting local network or device, click **Enable** to reconnect the device and restore device communication

6.5 Regular Shift Setting Schedule

Regular shifts can choose one or more normal time periods to form a regular shift according to laws. Regular shifts are often used in regular occasions, such as office buildings, governments, banks, etc.

6.5.1 Timetable

6.5.1.1 Add Normal Timetable

This paper introduces the configuration Steps of adding normal time period to the regular shift configuration of VAORIDA.

Operating Steps:

Step 1: In the **Attendance** module, select **Schedule Management > Time Period** and click **Add Normal Time Period**.

Step 2: Configure the time period information in the **Add Normal Time** Period window, as shown in Figure 6-24. Please refer to Table 6-5 for the explanation of key parameters.

Figure 6- 24 New Time Period

Parameter	Description
Before/after work, Before/after work	Set the valid range of check-in/check-out for this time period, and the check-in/check-out records outside this range are invalid records. The valid sign-in time after going to work and the valid sign-out time before going off work cannot overlap, which must be filled in.
Minutes allowed to be late/leave early	Refers to how long it is allowed to be late and leave early within the specified time points for going to and from work, and the

Parameter	Description
	minutes allowed to be late and leave early must be within the valid time range of sign-in and sign-out before they can take effect.
You must sign in/return	In the selected time range, set whether you must sign in and sign out when going to and from work.
Whether it is deducted between segments	When used for attendance calculation, whether to subtract the number of minutes defined by inter-segment deduction for this time period.
Start counting overtime before/after N minutes from work/work, with the shortest overtime minutes and the maximum overtime hours limited	Select whether to record the verification records before and after work as overtime.
Enable flexible hours to work	It refers to the flexible working parameter that people who go to work early can get off work early and people who work at night need to get off work late. When checked, you need to set the number of minutes that can be advanced/delayed, and it must be within the valid sign-in/sign-out time range.

Table 6- 5 Description of Key Parameters

Step 3: Click **OK**.

6.5.1.2 Add Flexible Timetable

Operating Steps:

Step 1: In the **Attendance** module, select **Schedule Management > Time Period** and click **Add Flexible Timetable**.

Step 2: Configure the time period information in the **Add Flexible Timetable** window.

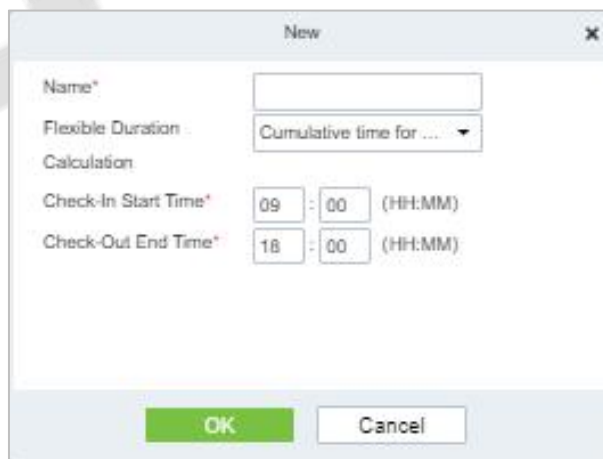

Figure 6- 25 Adding Flexible TimeTable

6.5.1.3 Delete

Step 1: In the **Timetable** interface, select the required Type from the list.

Step 2: Click **Delete** or click on the  icon to delete the required Timetable Type from the list.

Step 3: Click **Delete**, to ensure and delete the selected Type from the list.

6.5.1.4 Add Regular Shift

Operating Steps:

Step 1: In the **Attendance** module, select '**Schedule Management > Shift**' and click **"Add Regular Shift"**.

Step 2: Configure shift information in the "Add Regular Shift" window, as shown in Figure 6-26. Please refer to Table 6-6 for explanation of key parameters.

Figure 6- 26 New Shift

Parameter	Description
Unit	Set the unit of the cycle, and the default is "day". There are three types of units: <ul style="list-style-type: none"> • Day • Week • Month
Period	Defines the number of cycles of a shift, and the cycle of the shift = cycle number * units. <ul style="list-style-type: none"> • If the unit is "day", the range is 1 to 99. • If the unit is "week", the range is 1 to 15. • If the unit is "month", the range is 1 to 12.
Period starting type	This field is displayed only when the cycle unit is Day, Description <ul style="list-style-type: none"> • It is not displayed when the units are "week" and "month". • There is cycle start date and scheduling start date, and the default is cycle start date. • If you select Scheduling Start Date, the start date when scheduling is the first day of the cycle.
Period start date	This field is displayed only when the cycle start type is Cycle Start Date. Define the start date of the shift, and the date before the start date is not affected by the shift. The default system start date is the current system date.
Type of work	<ul style="list-style-type: none"> • Normal work: This shift is a normal work shift • Overtime on rest days: This shift is overtime on rest days • Overtime on holidays: This shift is overtime on holidays.

Parameter	Description
Attendance mode	<ul style="list-style-type: none"> • Swipe the card normally according to the shift: the default item of the system, and punch in normally according to the punch in. • Brush a valid card once a day: only need to brush the card once in the swiping interval defined by the time period within one day, even if it is normal to punch in. • Punch-in-free: Setting this shift can avoid punch-in.
Overtime mode	<ul style="list-style-type: none"> • Computer automatic calculation: It is connected with "whether the delay counts overtime" in the time period. When "whether the delay counts overtime" is "no", the delayed overtime is not calculated, and the overtime time of the overtime bill is not calculated at the same time. • Overtime must be applied: delayed overtime is not calculated, only the overtime order shall prevail; When the signing-back time is less than the end time of overtime, the overtime time is not calculated. • Not counting overtime: overtime hours are not counted for delayed overtime or overtime application.

Table 6- 6 Description of Key Parameters

Step 3: Click **OK**.

6.5.1.5 Add Flexible Shift

Step 1: In the shift interface, click **Set Time Period** under the operation bar of the added regular shift, and configure the time period information in the pop-up **Set Time Period** window.

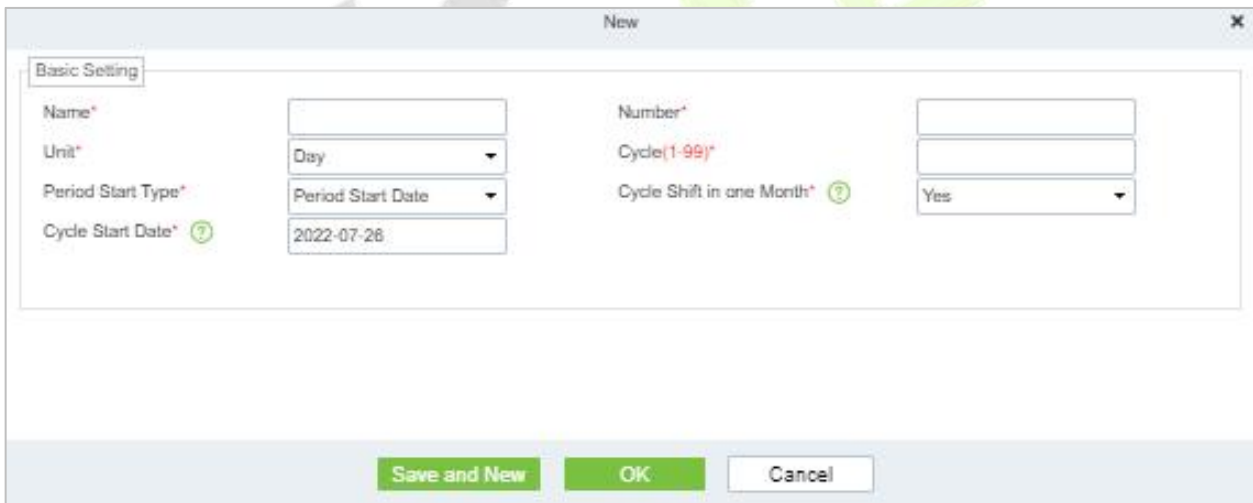

Figure 6- 27 Adding Flexible Shift

6.5.1.6 Delete

Step 1: In the **Shift** interface, select the required Shift Type from the list.

Step 2: Click **Delete** or click on the  icon to delete the required Shift Type from the list.

Step 3: Click **Delete**, to ensure and delete the selected Shift Type from the list.

6.5.1.7 Clear Timetable

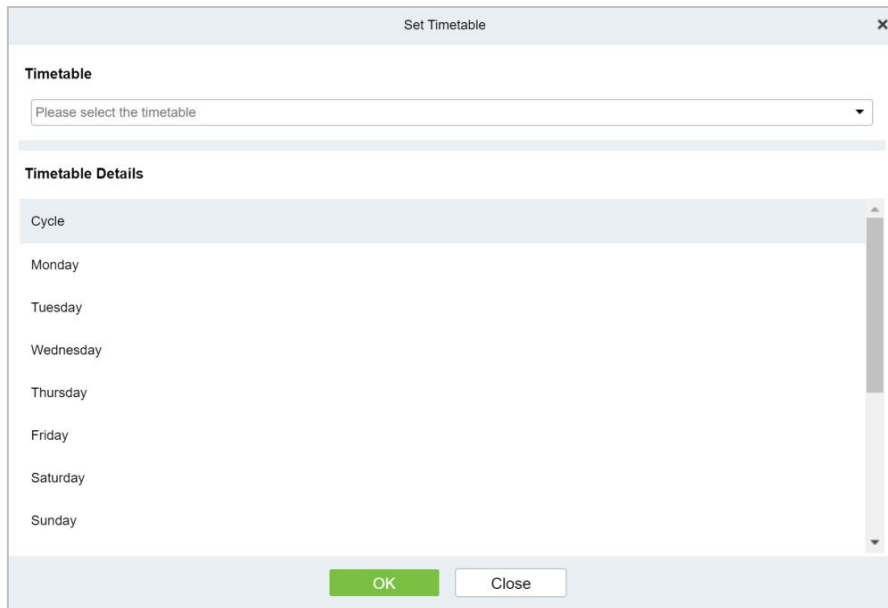

Figure 6- 28 Adding Time Periods

Step 6: Click **OK** to complete the addition of time period, and the specific time period is displayed in the time period details on the right.

6.5.2 Personnel Schedule

Personnel scheduling operations is completely same as group scheduling, but when scheduling personnel, the object of choice is personnel at the top left corner of the interface.

6.5.2.1 Cycle Schedule

Step 1: In the **Attendance** module, select **Schedule Management > Personnel Schedule** and click **Cycle Schedule**.

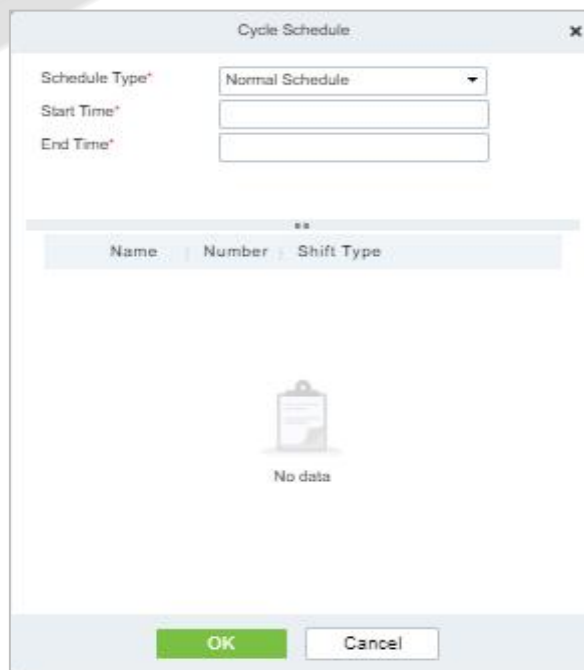

Figure 6- 29 Adding Personnel Schedule

6.5.2.2 Temporary Schedule

Step 1: In the **Attendance** module, select **Schedule Management > Personnel Schedule** and click **Temporary Schedule**.

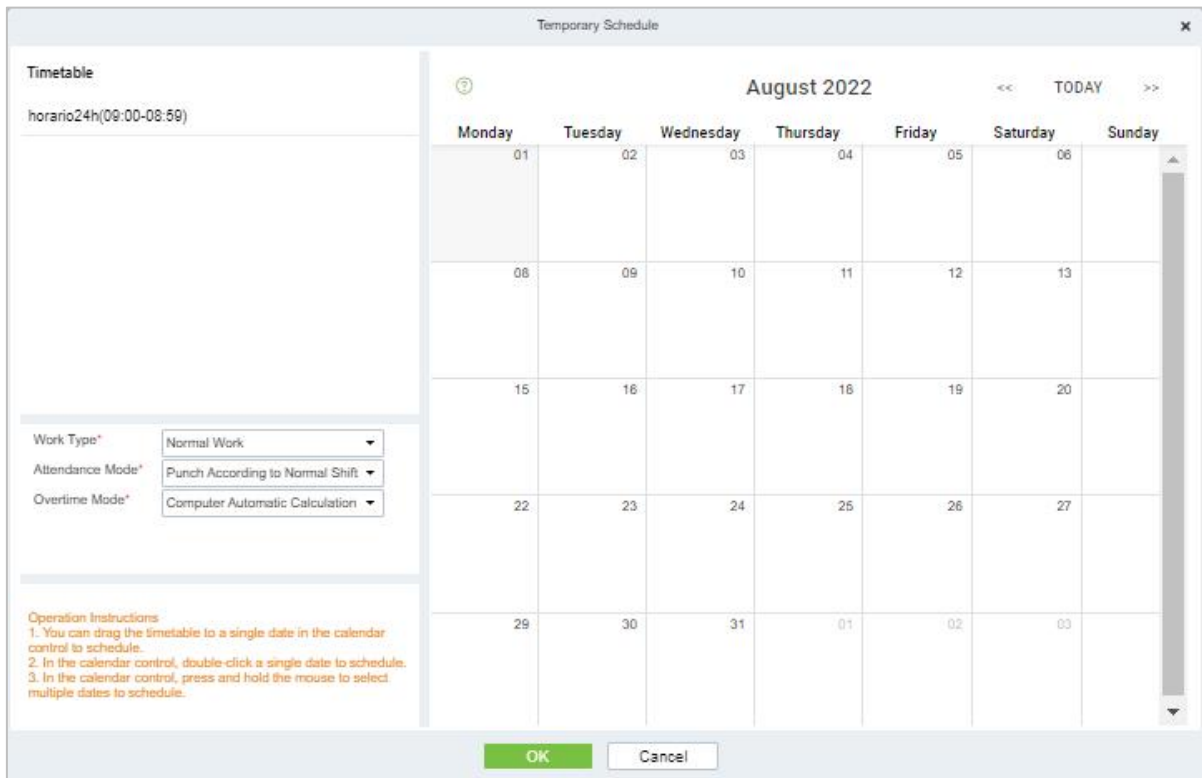

Figure 6- 30 Adding Temporary Schedule

6.5.2.3 Clear Cycle Schedule

Step 1: In the **Attendance** module, select **Schedule Management > Personnel Schedule** and then click on the Personnel ID that you want to delete, and click **Clear Cycle Schedule**.

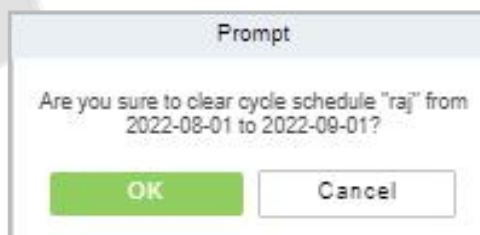

Figure 6- 31 Clear cycle schedule

6.5.2.4 Clear Temporary Schedule

Step 1: In the **Attendance** module, select **Schedule Management > Personnel Schedule** and then click on the Personnel ID that you want to delete, and click **Clear Temporary Schedule**.

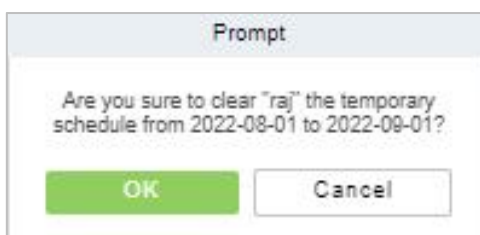

Figure 6- 32 Clear Temporary Schedule

6.5.3 Group Schedule

Grouping scheduling means grouping people, and then scheduling people in batches by grouping. This paper introduces the configuration Steps of grouping cycle scheduling in.

6.5.3.1 Edit Personnel for Group

- **New**

Step 1: In the **Attendance** module, select **Schedule > Group Schedule** and click **New**.

Step 2: Configure the Schedule Name in the **Group Schedule** interface.

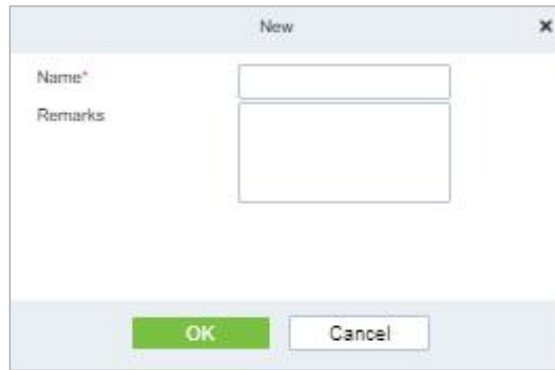

Figure 6- 33 Adding Elastic Time Period

Parameter	Description
Name	Can not contain special symbols, period name can not be duplicated, length is 30 characters, required.
Remarks	Mentioning comments.

Table 6- 7 Description of Key Parameters

Step 3: Click **OK**.

- **Delete**

Step 1: In the **Schedule** interface, select the required Shift Type from the list.

Step 2: Click **Delete** or click on the  icon to delete the required Shift Type from the list.

Step 3: Click **Delete**, to ensure and delete the selected Shift Type from the list.

6.5.3.2 Browse the Group Personnel

- **Delete Personnel**

Step 1: In the **Schedule** interface, select the required Personnel ID from the list.

Step 2: Click **Delete** or click on the  icon to delete the required Personnel ID from the list.

Step 3: Click **Delete**, to ensure and delete the selected Personnel ID from the list.

- **Cycle Schedule**

Step 1: In the **Attendance** module, select **Scheduling Management > Personnel Scheduling**, check the personnel under the department that needs scheduling or the designated personnel, and click "Periodic Scheduling".

Step 2: Configure scheduling information in the pop-up **Cycle Scheduling** window, as shown in Figure 6-34. Please refer to Table 6-8 for parameter description.

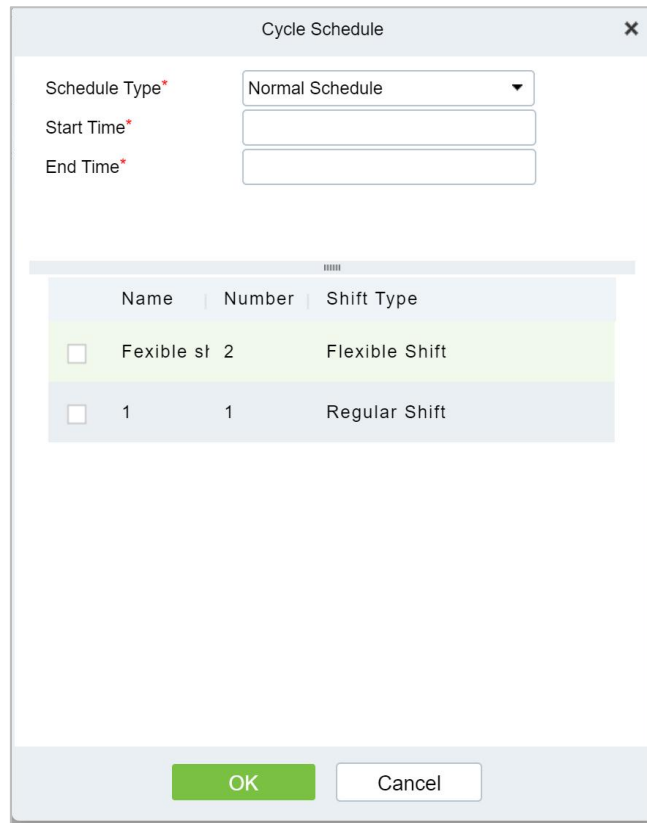

Figure 6- 34 Cycle Scheduling

Parameter	Description
Scheduling Type	<ul style="list-style-type: none"> Normal Shift Scheduling: Only one shift can be selected for normal shift scheduling Intelligent scheduling: Intelligent scheduling can select multiple shifts. Select intelligent scheduling, and the software will automatically judge the most suitable shift according to the punch-in record for attendance calculation.
Start Time/End Time	Set which date segment the schedule works on.
Select Shift	Select the shift to use for scheduling.

Table 6- 8 Description of Key Parameters of Cycle Scheduling

Step 3: Click **OK** to complete the configuration of personnel cycle scheduling.

● **Temporary Schedule**

Step 1: In the **Attendance** module, select '**scheduling Management > Personnel Scheduling**', check the personnel under the department that needs scheduling or the designated personnel, and click "Periodic Scheduling".

Step 2: Configure scheduling information in the pop-up **Temporary Schedule** window, as shown in Figure 6-35. Please refer to Table 6-9 for parameter description.

Step 3: Click **OK** to complete the configuration of temporary personnel scheduling

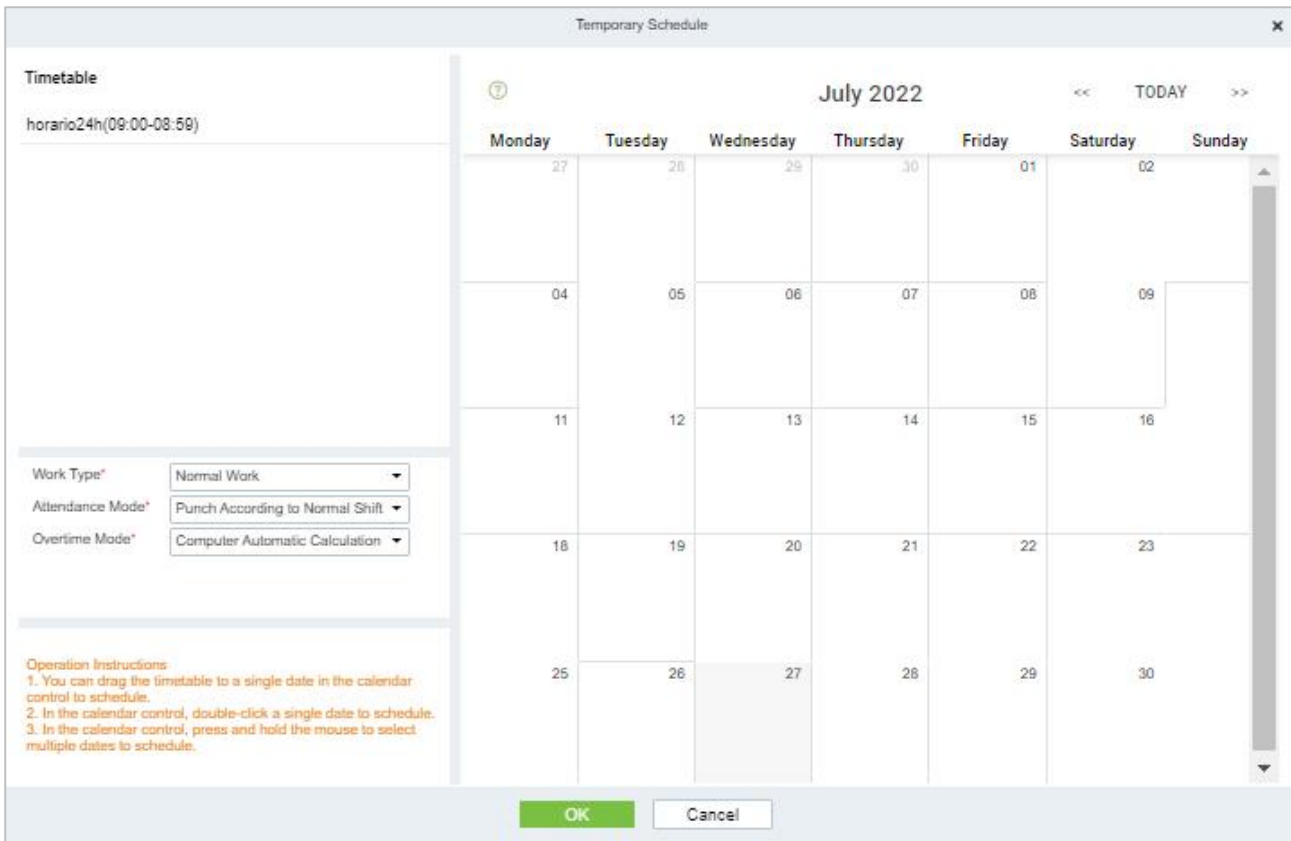

Figure 6- 35 Group Temporary schedule

Parameter	Description
Type of Work	<ul style="list-style-type: none"> • Normal work: This shift is a normal work shift. • Overtime on rest days: This shift is overtime on rest days. • Overtime on holidays: This shift is overtime on holidays.
Attendance Mode	<ul style="list-style-type: none"> • Swipe the card normally according to the shift: the default item of the system, and punch in normally according to the punch in • Brush a valid card once a day: only need to brush the card once in the swiping interval defined by the time period within one day, even if it is normal to punch in. • Punch-in-free: Setting this shift can avoid swiping cards.
Overtime Mode	<ul style="list-style-type: none"> • Computer automatic calculation: It is connected with "whether the delay counts overtime" in the time period. When "whether the delay counts overtime" is "no", the delayed overtime is not calculated, and the overtime time of the overtime bill is not calculated at the same time. • Overtime must be applied: delayed overtime is not calculated, only the overtime order shall prevail; When the signing-back time is less than the end time of overtime, the overtime time is not calculated. • Not counting overtime: overtime hours are not counted for delayed overtime or overtime application.

Table 6- 9 Description of Key Parameters of Temporary Scheduling

● Clear Cycle Schedule

Step 1: In the **Attendance** module, select **Scheduling Management > Personnel Scheduling**, check the personnel under the department that needs scheduling or the designated personnel, and click **Periodic Scheduling**.

Step 2: Configure scheduling information in the pop-up **Clear Cycle Schedule** window.

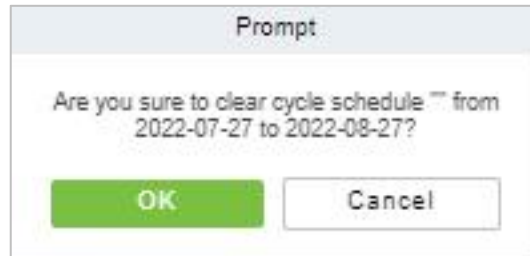



Figure 6- 36 Group Clear cycle Schedule

6.5.4 Schedule Details

After setting the attendance time period and shift, you can schedule the personnel.

6.5.4.1 Delete

Step 1: In the **Schedule** interface, select the required Personnel ID from the list.

Step 2: Click **Delete** or click on the  icon to delete the required Personnel ID from the list.

Step 3: Click **Delete**, to ensure and delete the selected Personnel ID from the list.

6.5.4.2 Export

You can export all transactions in Excel, PDF, CSV format

6.6 Exception

6.6.1 Appended Log

In the case of personnel going out on business or forgetting to punch in, the manual supplementary recording of attendance records in the attendance report is called supplementary signing card, which is generally summarized and entered by the management personnel according to the attendance results and the attendance system of the enterprise after the attendance cycle ends.

6.6.1.1 New

Operating Steps:

Step 1: In the **Attendance** module, select **Exception Management > Appended Log** and click **Add**.

Step 2: Configure the card replacement information in the pop-up **Add** window, first select the "Department" where the person to be resigned is located, then select the person to be resigned, and finally enter the date and time of the card replacement.

The screenshot shows a 'New' window for adding a replacement card. It features search fields for Personnel ID and Name. Below are two tables: 'Alternative' and 'Selected(1)'. The 'Alternative' table has columns for Personnel ID, First Name, Last Name, and Department. A row with Personnel ID '1' and Department 'Solution' is selected. The 'Selected(1)' table also shows this row. Below the tables are input fields for Punch Date (2021-12-18) and Punch Time (15:42), and a Remarks field. At the bottom are buttons for 'Save and New', 'OK', and 'Cancel'.

Figure 6- 37 Replacement Card

Step 3: Click **OK**.

6.6.1.2 Delete

Step 1: In the **Appended Log** interface, select the required Personnel ID from the list.

Step 2: Click **Delete** or click on the  icon to delete the required Personnel ID from the list.

Step 3: Click **Delete**, to ensure and delete the selected Personnel ID from the list.

6.6.1.3 Approval

Passed: The approval by the Supervisor, and more than a certain number of days approved by the Manager.

Refused: The denial of leave by the immediate Supervisor and the Manager.

6.6.1.4 Export

You can export all logs in Excel, PDF, CSV format.

6.6.1.5 Import

You can import all logs in Excel, PDF, CSV format.

6.6.2 Ask For Leave

When encountering special circumstances, people may need to take time off for different reasons, and hope that the time off can be displayed in the system statistics.

6.6.2.1 New

Operating Steps:

Step 1: In the **Attendance** module, select **Exception Management > Leave** and click **New**.

Step 2: Configure the leave form information in the pop-up **Add** window, first select the "Department" where the person to take leave is located, then select the leave person, finally enter the leave time, and optionally upload the leave attachment.

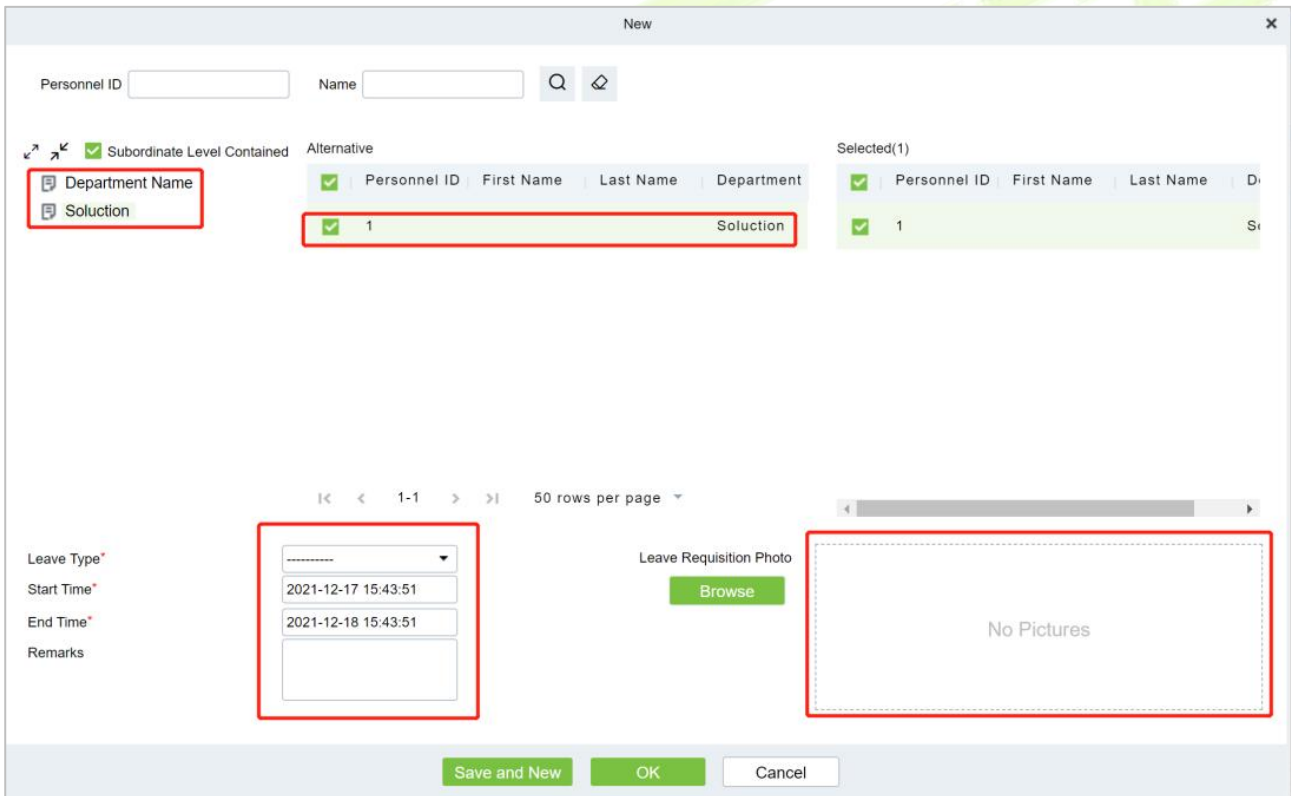



Figure 6- 38 Leave Request Form

Step 3: Click **OK**.

6.6.2.2 Delete

Step 1: In the **Leave** interface, select the required Personnel ID from the list.

Step 2: Click **Delete** or click on the  icon to delete the required Personnel ID from the list.

Step 3: Click **Delete**, to ensure and delete the selected Personnel ID from the list.

6.6.2.3 Approval

Passed: The approval by the Supervisor, and more than a certain number of days approved by the Manager.

Refused: The denial of leave by the immediate Supervisor and the Manager.

6.6.2.4 Export

You can export all logs in Excel, PDF, CSV format.

6.6.2.5 Import

You can import all logs in Excel, PDF, CSV format.

6.6.3 Overtime

6.6.3.1 New

Step 1: In the **Attendance** module, select **Exception Management > Overtime** and click **New**.

Step 2: Configure overtime form information in the pop-up **Add** window, first select the "Department" where the person to work overtime is located, then select the overtime person, and finally enter overtime hours.

The screenshot shows a 'New' window for creating an overtime record. It features search fields for 'Personnel ID' and 'Name'. Below these are two tables: 'Alternative' and 'Selected(1)'. The 'Alternative' table has columns for 'Personnel ID', 'First Name', 'Last Name', and 'Department', with a row containing '1' and 'Solution' selected. The 'Selected(1)' table has columns for 'Personnel ID', 'First Name', and 'Last Name', with a row containing '1' selected. On the left, there are dropdown menus for 'Department Name' and 'Solution'. At the bottom, there are input fields for 'Start Time' (2021-12-18 15:45:12), 'End Time' (2021-12-18 15:45:12), 'Overtime Duration(Minutes)' (0), and 'Remarks'. Navigation and pagination controls are visible above the input fields. At the bottom of the window are 'Save and New', 'OK', and 'Cancel' buttons.

Figure 6- 39 Overtime Form

Step 3: Click **OK**.

6.6.3.2 Delete

Step 1: In the **Overtime** interface, select the required Personnel ID from the list.

Step 2: Click **Delete** or click on the  icon to delete the required Personnel ID from the list.

Step 3: Click **Delete**, to ensure and delete the selected Personnel ID from the list.

6.6.3.3 Approval

Passed: The approval by the Supervisor, and more than a certain number of days approved by the Manager.

Refused: The denial of leave by the immediate Supervisor and the Manager.

6.6.3.4 Export

You can export all logs in Excel, PDF, CSV format.

6.6.3.5 Import

You can import all logs in Excel, PDF, CSV format.

6.6.4 Adjust Rest

6.6.4.1 New

Operating Steps:

Step 1: In the **Attendance** module, select **Exception Management > Leave Adjustment** and click **New**.

Step 2: In the pop-up **Add** window, configure the information of the leave adjustment form, first select the "Department" of the person to be transferred, then select the person to be transferred, and finally enter the leave adjustment time.

The screenshot shows a 'New' window for leave adjustment. At the top, there are input fields for 'Personnel ID' and 'Name', followed by search and refresh icons. Below this is a table with two sections: 'Alternative' and 'Selected(0)'. The 'Alternative' section has a checkbox and columns for 'Personnel ID', 'First Name', 'Last Name', and 'Department'. The 'Selected(0)' section also has a checkbox and the same columns. Below the table is a pagination control showing '1-1' and '50 rows per page'. At the bottom, there is an 'Adjust Date' field with the value '2021-12-20' and a 'Remarks' text area. At the very bottom are three buttons: 'Save and New', 'OK', and 'Cancel'.

Figure 6- 40 Leave Adjustment Form

Step 3: Click **OK**.

6.6.4.2 Delete

Step 1: In the **Adjust Rest** interface, select the required Personnel ID from the list.

Step 2: Click **Delete** or click on the  icon to delete the required Personnel ID from the list.

Step 3: Click **Delete**, to ensure and delete the selected Personnel ID from the list.

6.6.4.3 Approval

Passed: The approval by the Supervisor, and more than a certain number of days approved by the Manager.

Refused: The denial of leave by the immediate Supervisor and the Manager.

6.6.4.4 Export

You can export all logs in Excel, PDF, CSV format.

6.6.4.5 Import

You can import all logs in Excel, PDF, CSV format.

6.6.5 Shift Adjustment

6.6.5.1 New

Operating Steps:

Step 1: In the **Attendance** module, select **Exception Management > Shift Adjustment** and click **New**.

Step 2: In the pop-up **Add** window, configure the shift adjustment list information, first enter the shift adjustment "Personnel Number", then select "shift Adjustment Date", and finally select "shift Adjustment Name".

The screenshot shows a 'New' window for creating a leave adjustment. It includes the following fields and controls:

- Adjust Type:** A dropdown menu with the selected option 'Adjust the personal s...'
- Personnel ID*:** A text input field containing the value '1'.
- First Name:** An empty text input field.
- Department Name:** A text input field containing the value 'Solution'.
- Adjust Date*:** A text input field containing the date '2021-12-18'.
- Adjust Shift Name:** A dropdown menu with a dashed line indicating a selection.
- Remarks:** A large empty text area for additional notes.
- Buttons:** Three buttons at the bottom: 'Save and New' (green), 'OK' (green), and 'Cancel' (white).

Figure 6- 41 Leave Adjustment Form

Step 3: Click **OK**.

6.6.5.2 Delete

Step 1: In the **Adjust Shift** interface, select the required Personnel ID from the list.

Step 2: Click **Delete** or click on the  icon to delete the required Personnel ID from the list.

Step 3: Click **Delete**, to ensure and delete the selected Personnel ID from the list.

6.6.5.3 Approval

Passed: The approval by the Supervisor, and more than a certain number of days approved by the Manager.

Refused: The denial of leave by the immediate Supervisor and the Manager.

6.6.5.4 Export

You can export all logs in Excel, PDF, CSV format.

6.6.5.5 Import

You can import all logs in Excel, PDF, CSV format.

6.7 Attendance Detail Report

6.7.1 Manual Calculation

In the Attendance Report, you can view the clock-in record of a person and check whether the attendance status of the person is correct through attendance calculation. If it is correct, it means that the attendance business configuration is completed.

Operating Steps:

Step 1: In **Attendance** Module, select **Detailed Report > Manual Calculation**, check the person who needs to perform attendance calculation, and click **Attendance Calculation**.

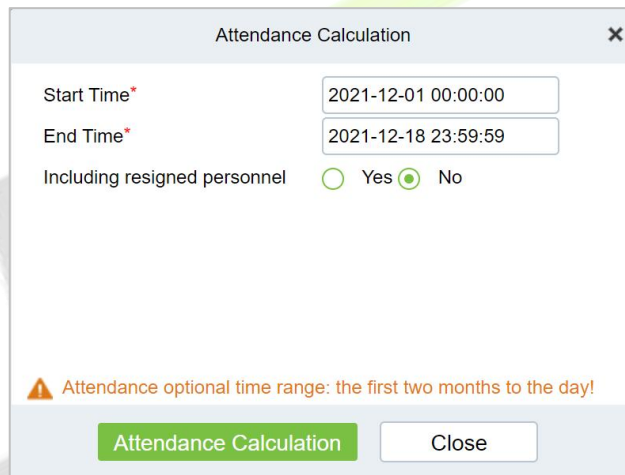

Figure 6- 42 Manual Calculation

6.7.1.1 Attendance Calculation

Step 1: In the **Attendance Calculation** window, configure the attendance calculation information, and click **Attendance Calculation**.

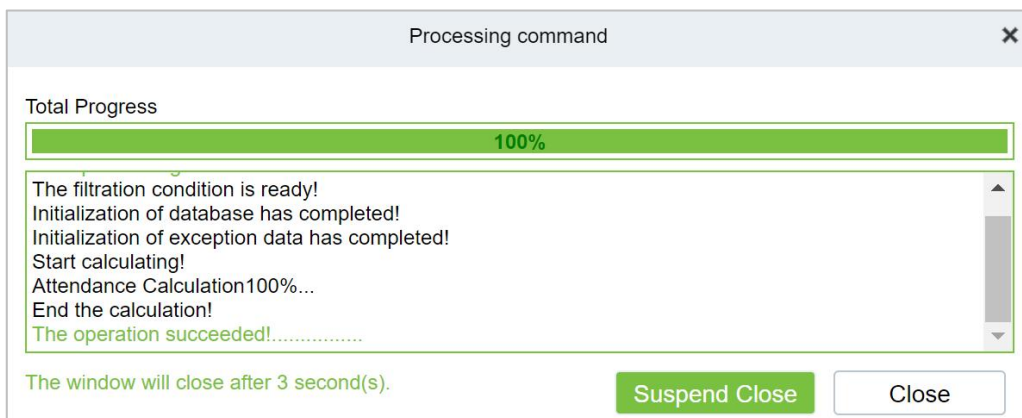

Figure 6- 43 Attendance Calculation

Step 2: After the calculation is completed, you can view related reports.

6.7.2 Attendance Transaction

Attendance records of all employees will be displayed on this interface, including the attendance record of uploaded attendance transactions. The record of the normal punch on the device will be uploaded to the software as the original record. When a particular data is selected, the details will be displayed on the right side of the page.

Operating Steps:

Step 1: In the **Attendance** module, select **Detailed Report > Transaction**.

Step 2: In the original record table interface, fill in the corresponding query information, and click the **Query** symbol to complete the query of all record tables.

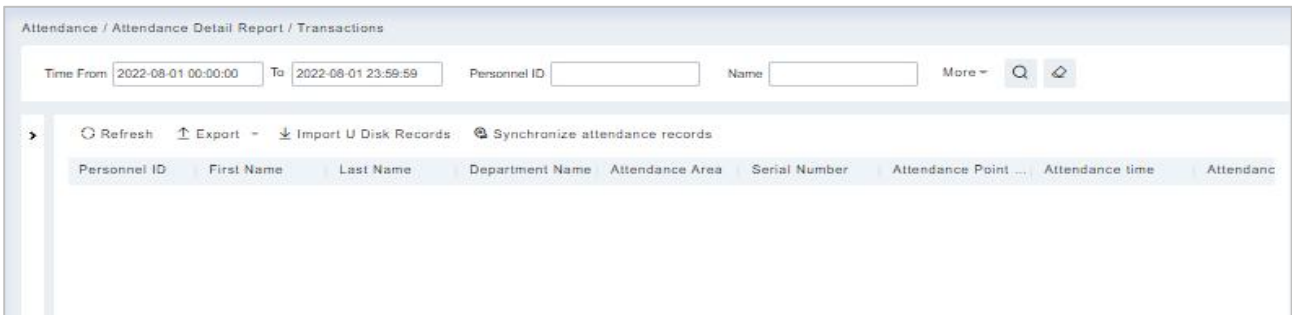

Figure 6- 44 Report Query Interface

6.7.2.1 Export

Step 1: In the original record table interface, click **Export**, enter the user password in the pop-up security verification, and click **OK**. Select whether to encrypt and export the file format, and click **OK**.

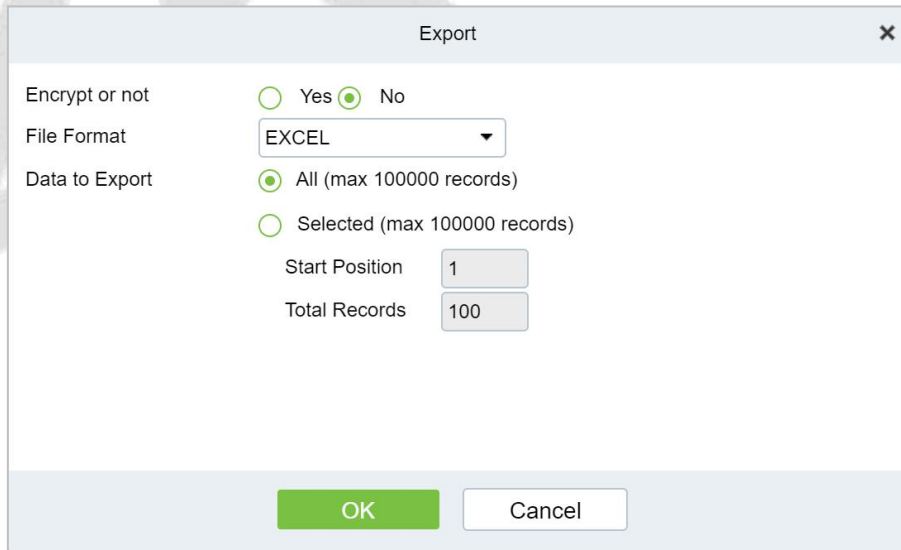

Figure 6- 45 Report Export Interface

Step 2: After selecting the address where the corresponding file is stored, the export of the file can be completed.

6.7.2.2 Import U Disk Records

The "Import U disk record" feature allows you to import the device data (including access control, parking, Faceiosk, Video records) to the transaction table.

6.7.2.3 Synchronize attendance records

The access control records can be synchronized to attendance records through this function. Select the start time and end time to import, check the attendance point list and click **OK**.

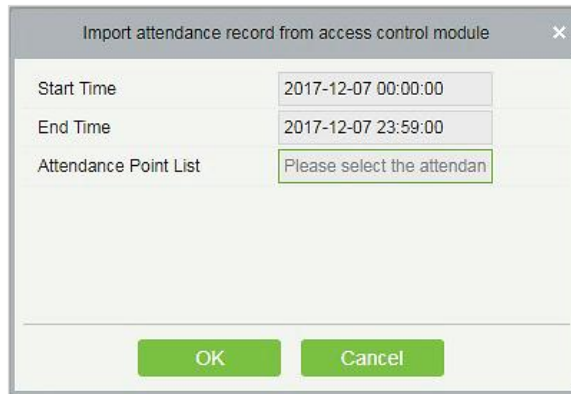

Figure 6- 46 Synchronize Attendance Records

6.7.3 Daily Attendance

The table shows personnel’s daily attendance status, punch time, the early leaving time, the latest time, the detailed punch time during the selected period.

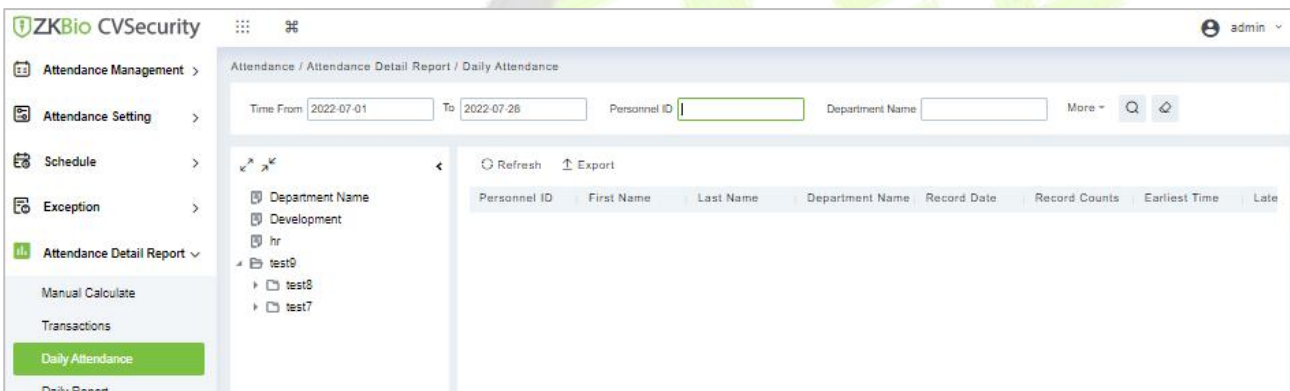

Figure 6- 47 Daily Attendance

6.7.3.1 Export

It will export the daily attendance record data. Currently it can be exported either in three types of file EXCEL/PDF/CSV. You can also choose the amount of data to be exported or select the maximum amount which supports up to 40,000 records.

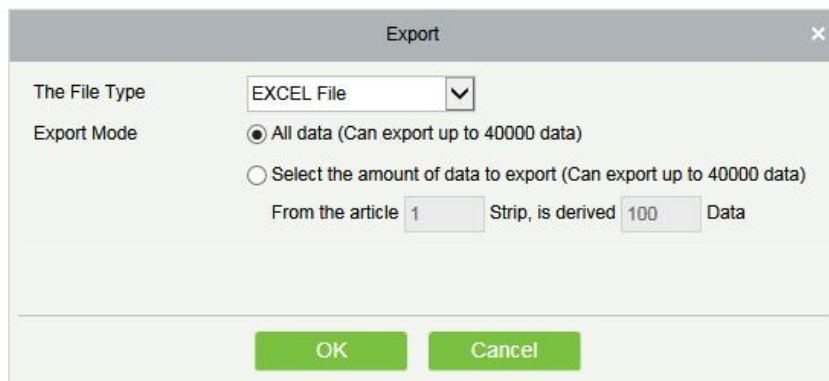

Figure 6- 48 Export Daily Attendance

6.7.4 Daily Report

This function is used to get the daily report within the specified range of date and time attendance details of personnel, including attendance, late arrival, early leaving, overtime and so on.

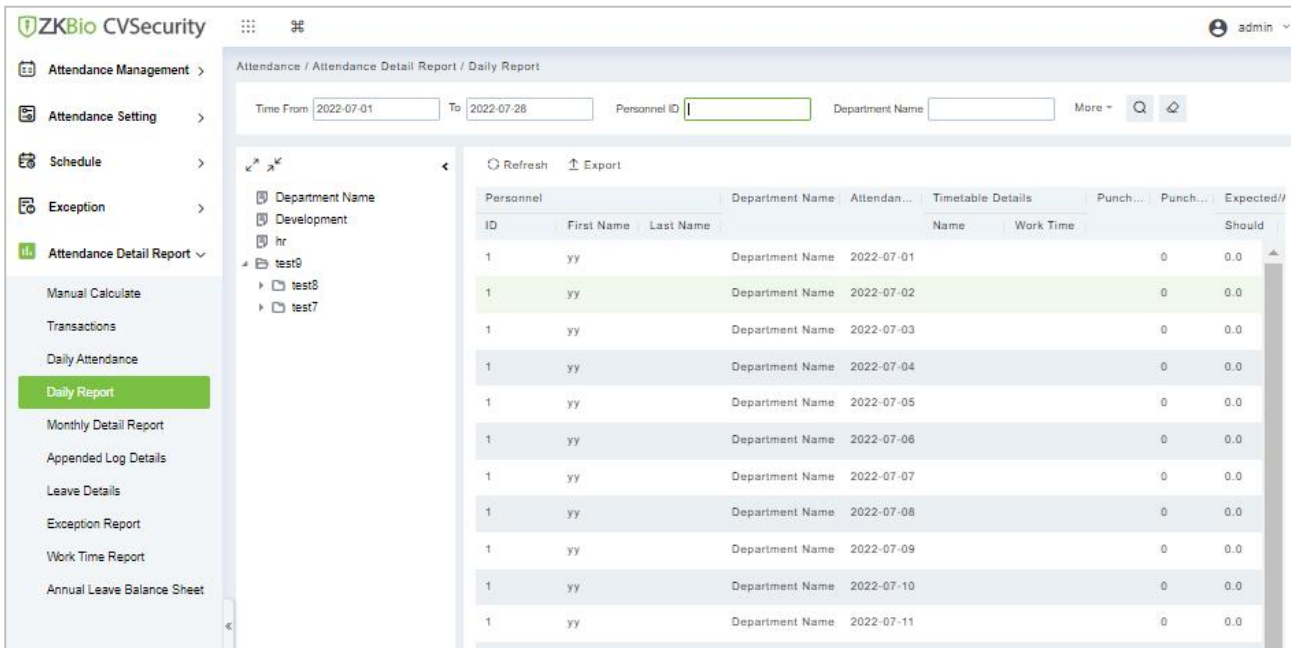

Figure 6- 49 Daily Report

6.7.4.1 Export

It will export the Daily report data. Currently it can be exported either in three types of file EXCEL/PDF/CSV. You can also choose the amount of data to be exported or select the maximum amount which supports up to 40,000 records.

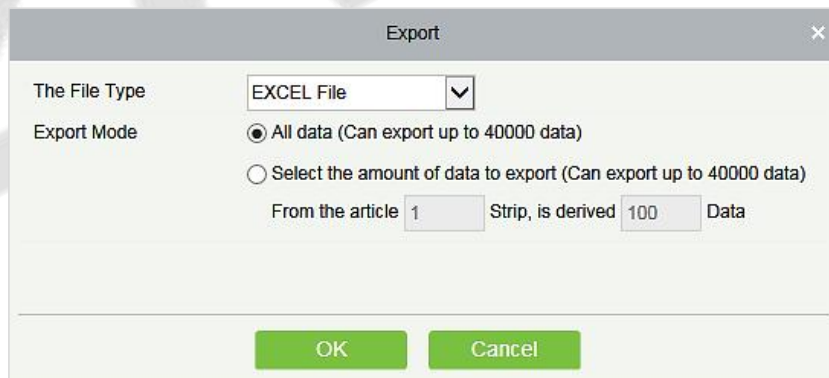

Figure 6- 50 Export Daily report

6.7.5 Monthly Detail Report

This function will automatically give the report for a selected month on a daily basis. The report includes attendance status and characters, and summarizes the actual attendance time, absence, leave, business trips and outings in the month.

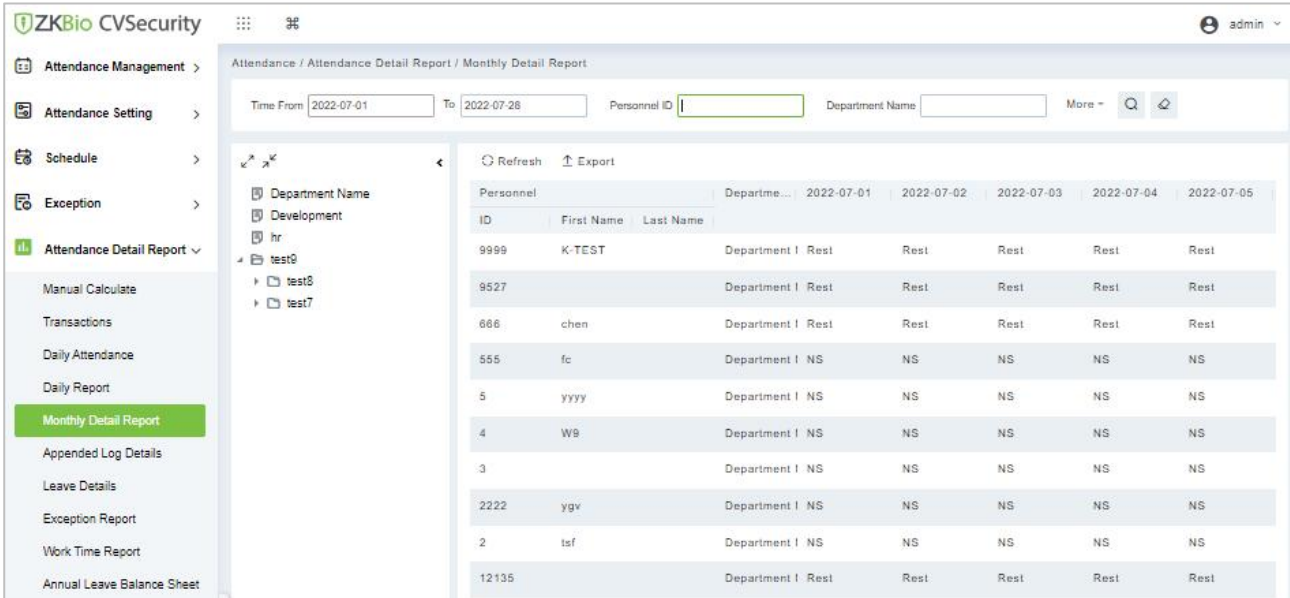

Figure 6- 51 Monthly Details Report

The attendance status is displayed as per following priority at the bottom of the interface.

6.7.5.1 Export

It will export the Monthly Detail Report data. Currently it can be exported either in three types of file EXCEL/PDF/CSV. You can also choose the amount of data to be exported or select the maximum amount which supports up to 40,000 records.

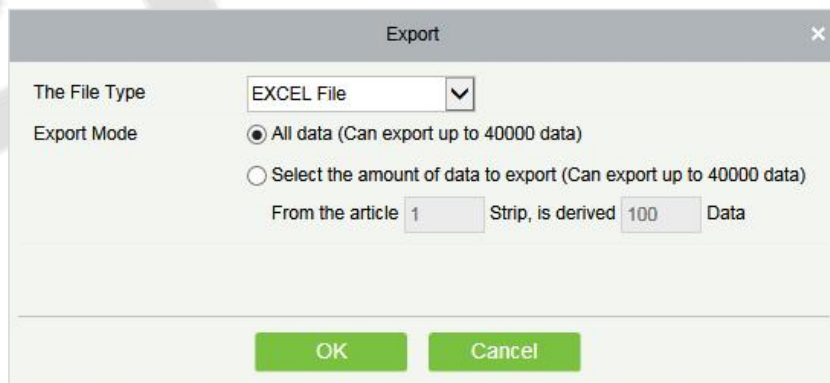

Figure 6- 52 Export Monthly Details Report

6.7.6 Appended Log Details

Appended Log Details is to get the personnel in case the person is out on a business trip.

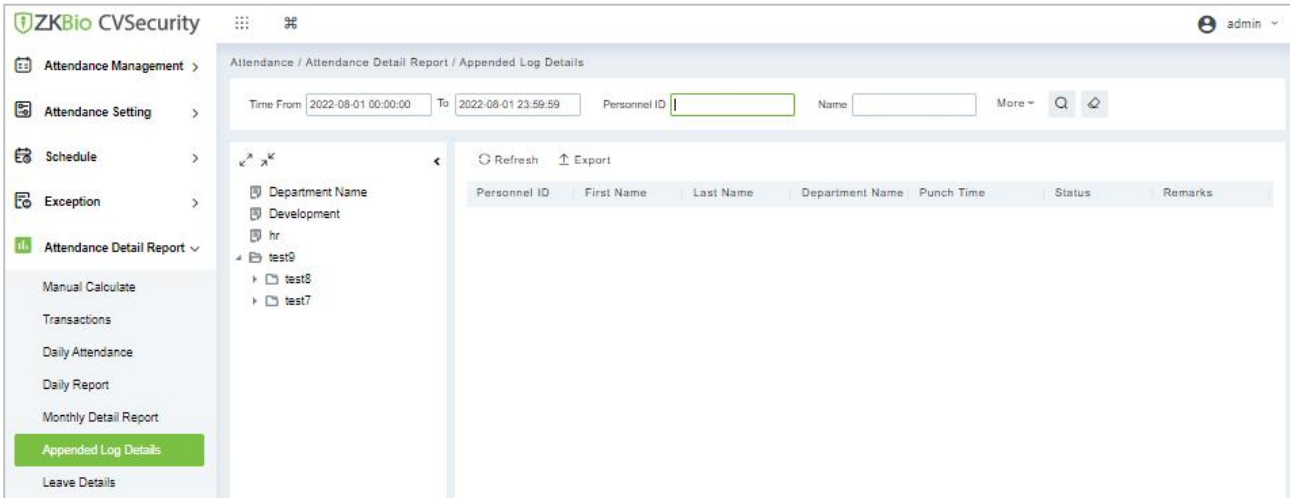

Figure 6- 53 Appended Log details

6.7.6.1 Export

You can export all logs in Excel, PDF, CSV format.

6.7.7 Leave Details

Personnel may need leave at different circumstances. They can apply and the leave will be displayed here:

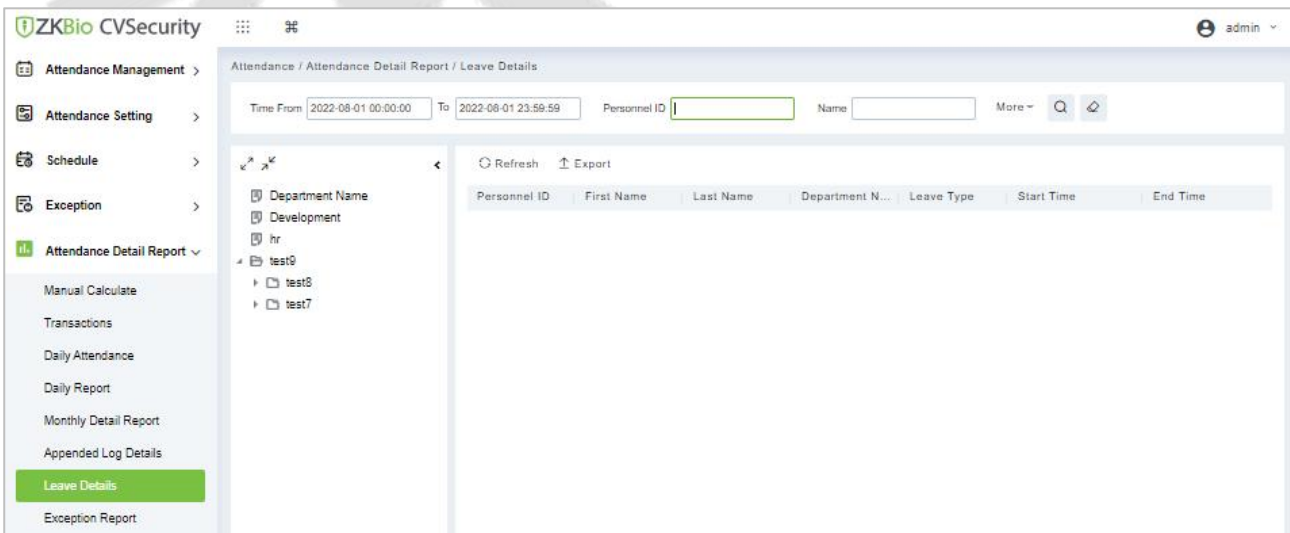

Figure 6- 54 Leave Details

6.7.7.1 Export

You can export all logs in Excel, PDF, CSV format.

6.7.8 Exception Report

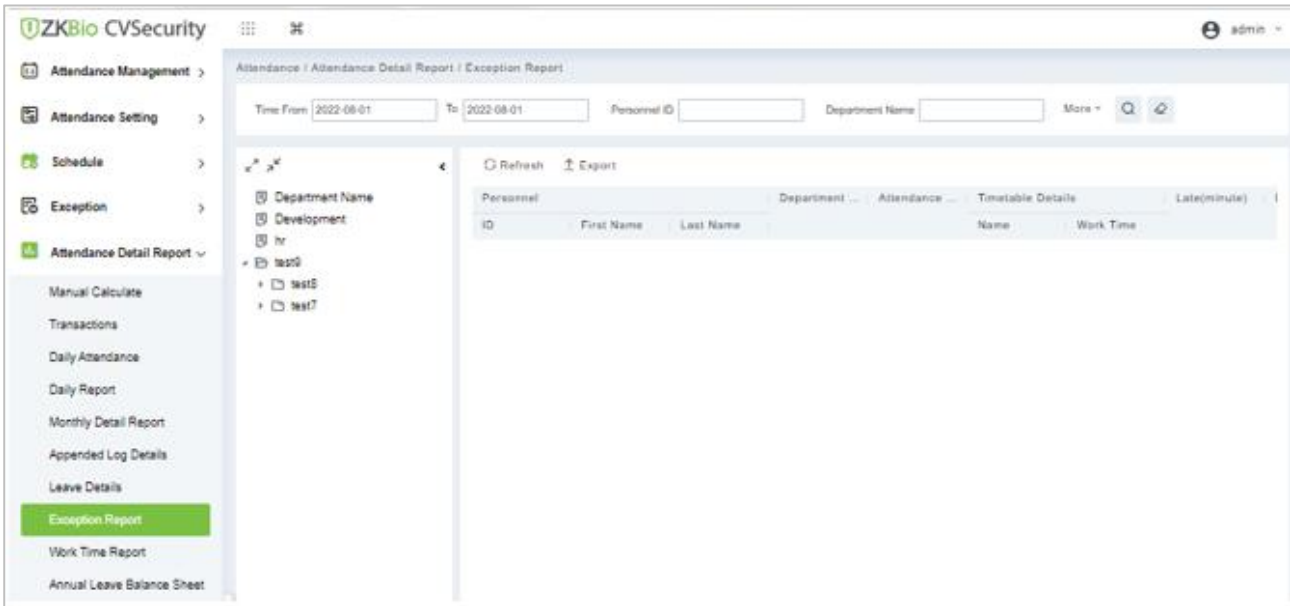

Figure 6- 55 Expception report

6.7.8.1 Export

You can export all logs in Excel, PDF, CSV format.

6.7.9 Work Time Report

This will be the total effective time of this shift. It is automatically set by the system as per the Check-in/out details.

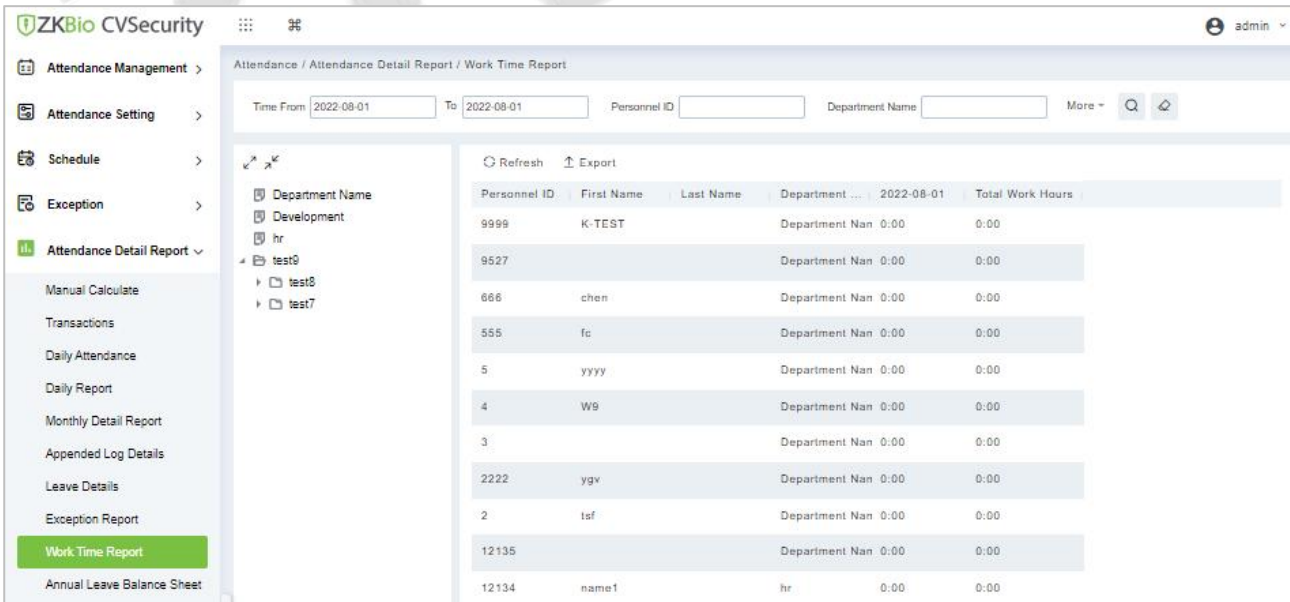

Figure 6- 56 Work Time Report

6.7.9.1 Export

You can export all logs in Excel, PDF, CSV format.

6.7.10 Annual Leave Balance Sheet

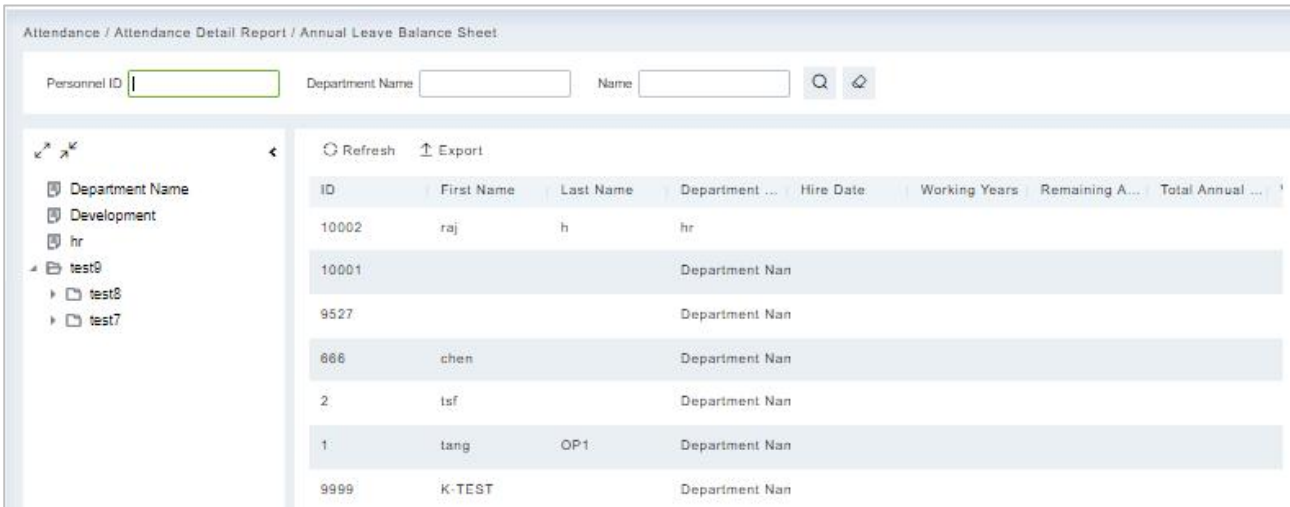

Figure 6- 57 Annual Leave Balance Sheet

6.7.10.1 Export

You can export all logs in Excel, PDF, CSV format.

6.8 Calculate Report

6.8.1 Leave Summary

The report summarizes the valid time for all valid leave records, leave type, within the selected date range. Select the time range from which you want to view the leave record.

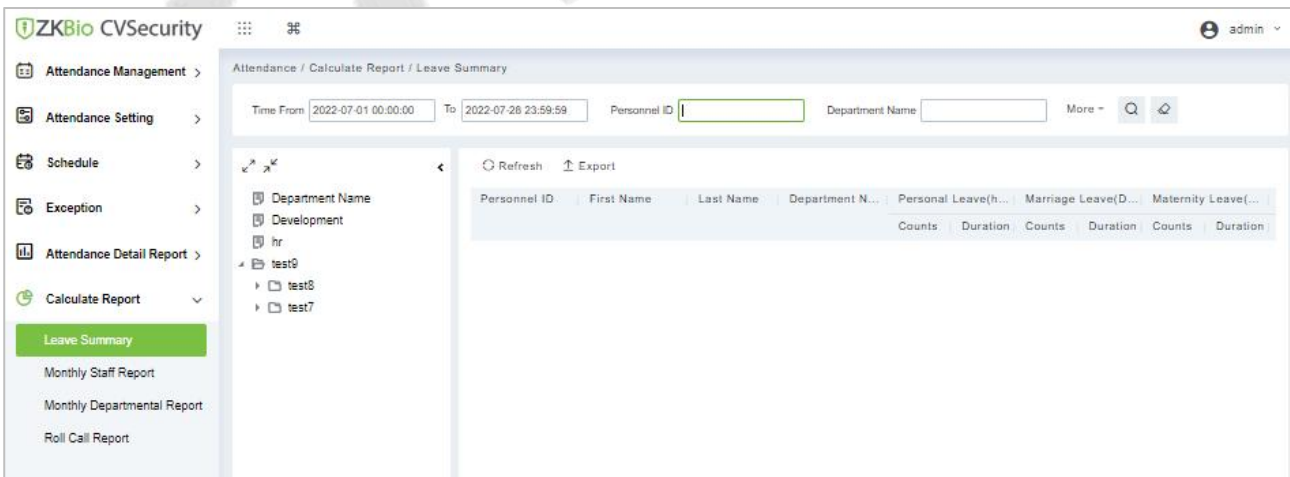

Figure 6- 58 Leave Summary Report

6.8.1.1 Export

It will export the leave summary data. Currently it can be exported either in three types of file EXCEL/PDF/CSV. You can also choose the amount of data to be exported or select the maximum amount which supports up to 40,000 records.

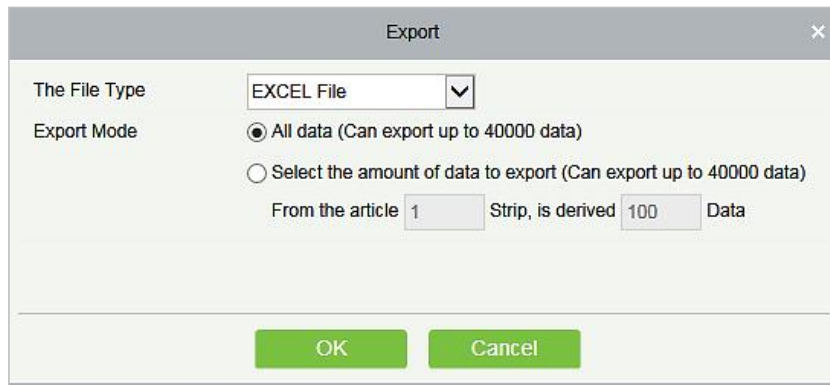

Figure 6- 59 Export Leave Summary Report

6.8.2 Monthly Staff Report

Select the Month to get the detail record of all the staff. Details include details of all personnel in the department, attendance, late, leaving early, and so on.

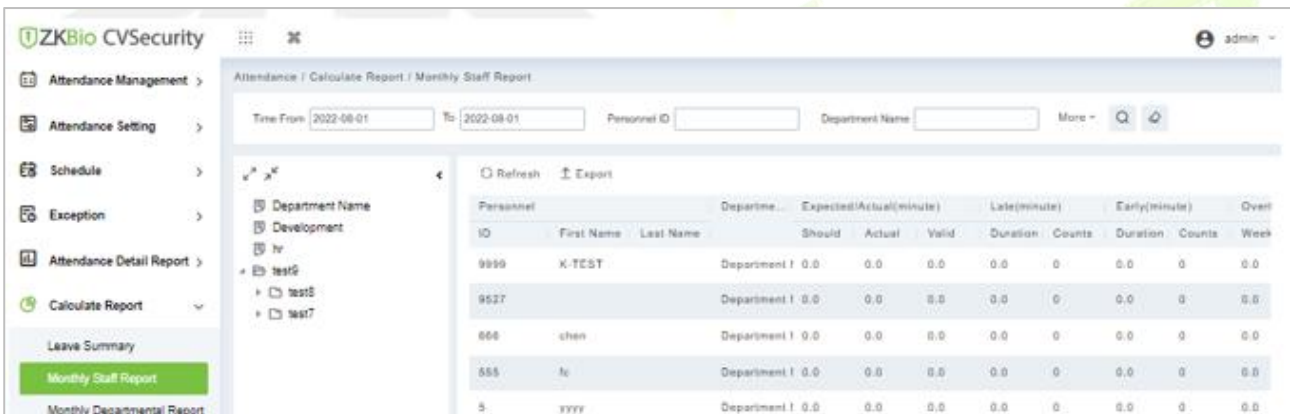

Figure 6- 60 Monthly Staff Report

6.8.2.1 Export

You can export all logs in Excel, PDF, CSV format.

6.8.3 Monthly Departmental

Select the date to get the detail record of all departments. Details include details of all personnel in the department, attendance, late, leaving early, and so on.

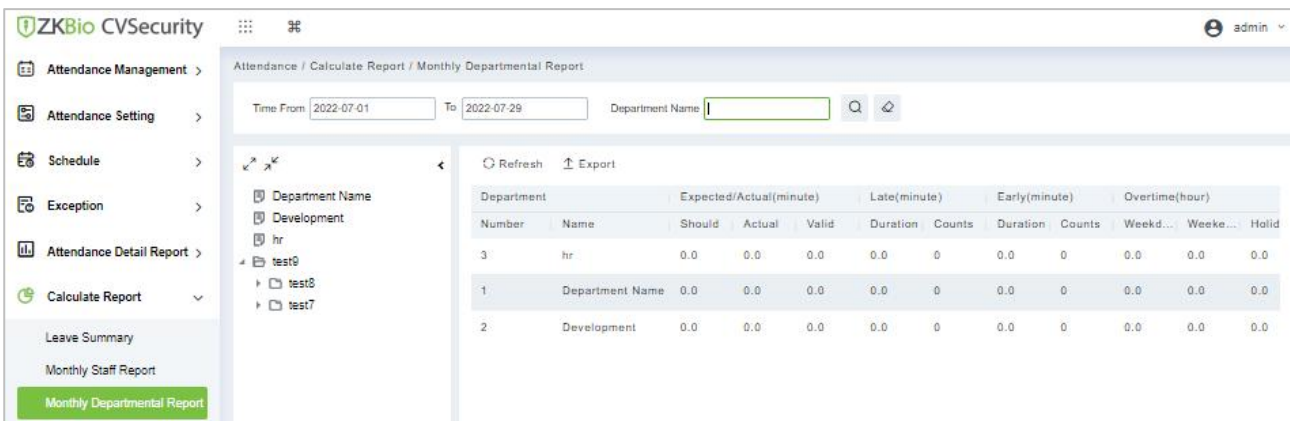

Figure 6- 61 Monthly Department Report

6.8.3.1.1 Export

You can export all logs in Excel, PDF, CSV format.

6.8.4 Roll Call Report

The procedure of identifying the availability by calling out a list of names

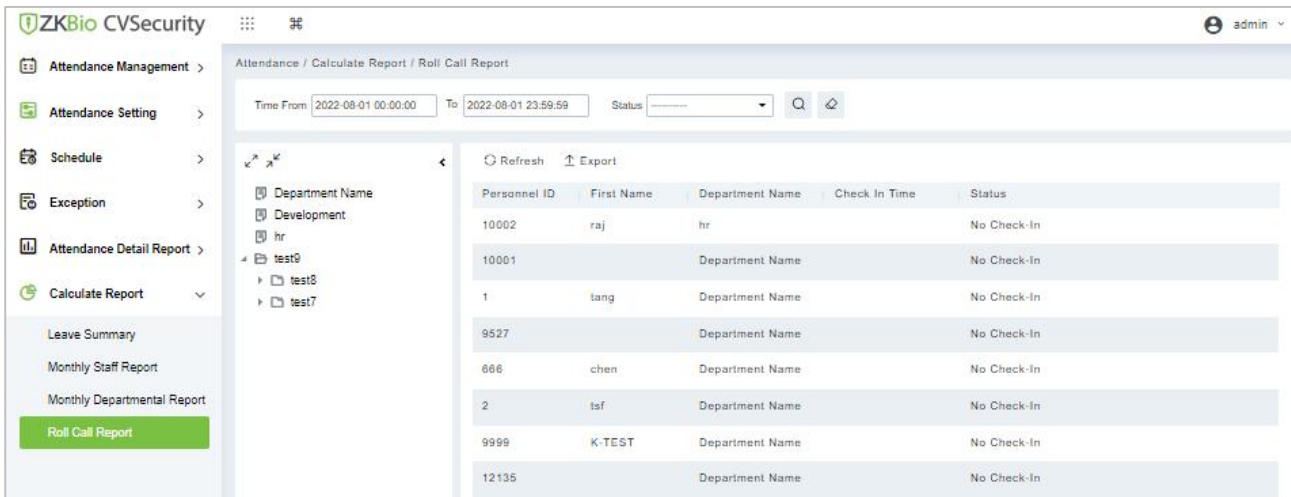

Figure 6- 62 Roll Call Report

6.8.4.1 Export

You can export all logs in Excel, PDF, CSV format.

7 Consumption

This module allows the user to set up a consumption system with the device and realize their functions. The device can be set as either a “Consumer Machine”, a “Cashier Machine” or a “Subsidy Machine”. The “Consumer machine” type combines various consumption modes to meet the diversified consumption requirements such as fixed value mode or amount mode. The “Cashier Machine” type realizes the device recharge and refund function. The “Subsidy machine” type is used to receive allowances/subsidies. This module will collect the data from the device and summarize it on the various consumption reports. It can also perform various operations like issue card, card return, card suspend and resume, and other operations through the card reader connected to the software.

Operation Scenario:

Online consumption management controls online consumption device through software, and sets different consumption patterns on the software side, thus realizing diversified consumption forms. Diversified consumption reports support multi-dimensional analysis and statistics of consumption data.

Operation Flow:

This paper introduces the configuration process of online consumption management.

The configuration process of online consumption management is shown in Figure 7-1.

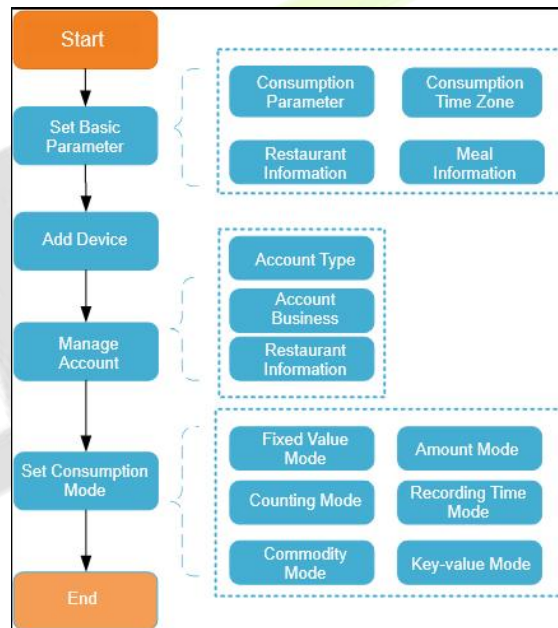

Figure 7-1 Online Consumption Configuration Process

7.1 Consumption Basic Information

This paper introduces that before using the consumption function in, it is necessary to set the relevant basic parameters, and then configure other functions, including Piecewise Fixed Value, Consumption time Zone, Restaurant Information, Meal Information, Commodity Information, Key Value Information, and Card Information.

Click **Consumption**, then select **Consumption Basic Information**.

7.1.1 Piecewise Fixed Value

Piecewise Fixed value is the value and validity of a card which is supposed to be used on the consumer device.

Click **Consumption > Consumption Basic Information**, then select **Piecewise Fixed Value.y**

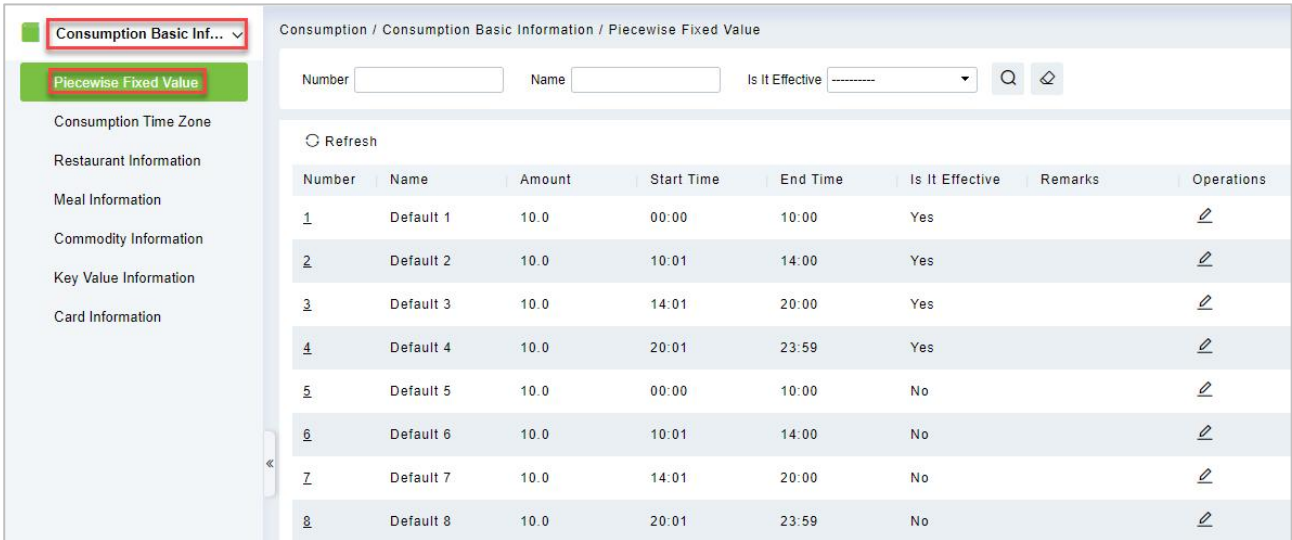

Figure 7-2 Piecewise Fixed Value

- **Edit**

By default, there are eight values, click on the operation column to open the modification dialog box.

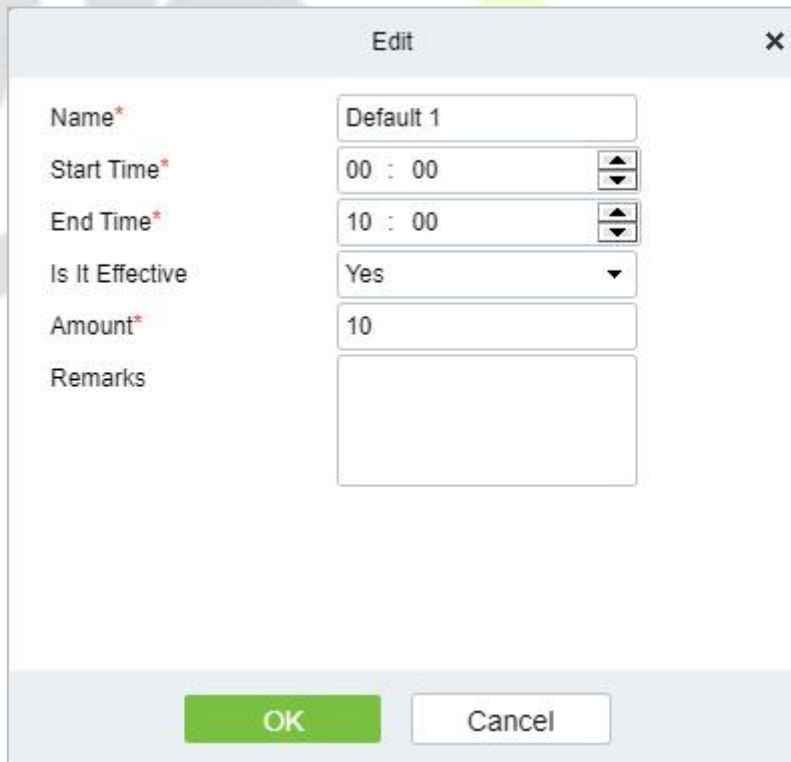

Figure 7-3 Edit Piecewise Fixed Value

In the dialog box, you can select the required **Name**, **start time**, **End time**, **Is It Effective**, **Amount** and **Remarks** (optional), as shown in the above figure 3.2. After providing the information, click **OK** to save and exit.

7.1.2 Consumption Time Zone

By default, the system has some Consumption Time zones, you can select and edit according to your preferences.

Click **Consumption > Consumption Basic Information**, then select Consumption Time Zone.



Figure 7-4 Consumption Time Zone

- **Edit**

Click on the operation column to open the modification dialog box.

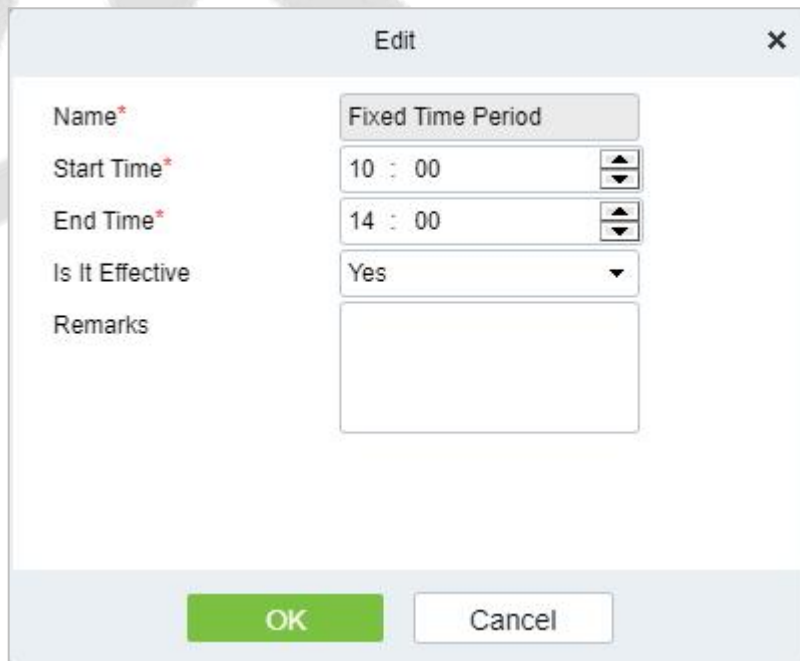

Figure 7-5 Edit Consumption Time Zone

In the dialog box, you can select the required **Name**, **start time**, **End time**, **Is It Effective**, **Amount** and **Remarks** (optional), as shown in the above figure 3.2. After providing the information, click **OK** to save and exit.

7.1.3 Restaurant Information

By default, a Restaurant name is already added, you can edit it and add new ones.

Click **Consumption > Consumption Basic Information**, then select **Restaurant Information**.

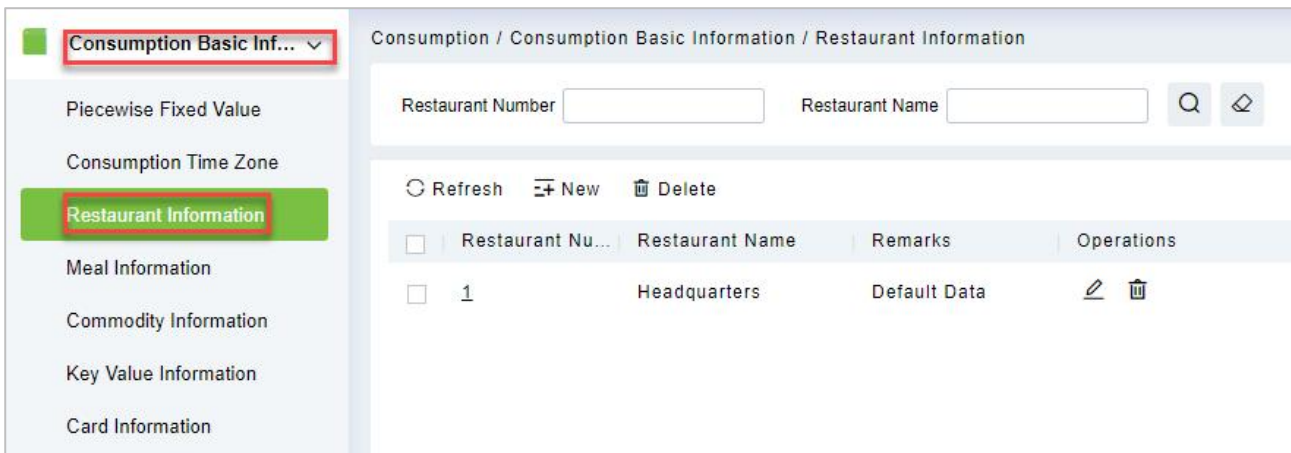

Figure 7-6 Restaurant Information

7.1.3.1 New

Click **Consumption > Consumption Basic Information > Restaurant Information**, then select **New**, to add a new restaurant.

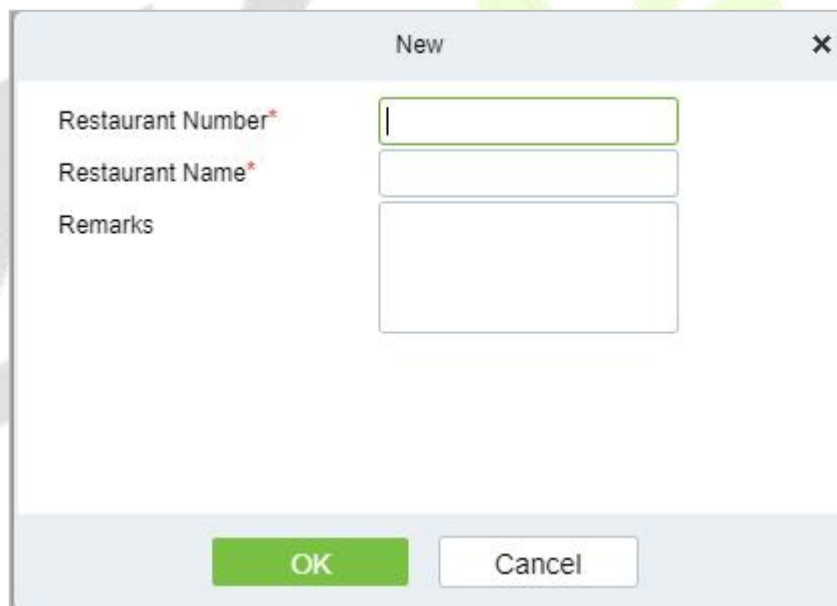

Figure 7-7 Add New Restaurant.

Fields are as Follows:

Parameter	Description
Restaurant Number	Enter Resaurant Number.
Restaurant Name	Enter Restaurant Name.
Remarks	Enter Remarks.

Table 7-1 Add New Restaurant

Click **OK**, to save and exit, or click **Save and New** for continue adding.

7.1.3.2 Delete

Click **Consumption > Consumption Basic Information > Restaurant Information**, then select **Delete**.

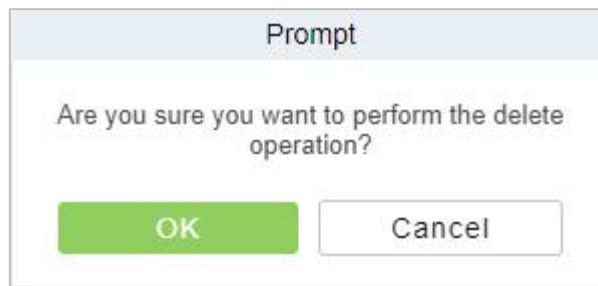

Figure 7-8 Delete Restaurant Information

7.1.4 Meal Information

Click **Consumption > Consumption Basic Information**, then select **Meal Information**.



Figure 7-9 Meal Information

7.1.5 Commodity Information

Click **Consumption > Consumption Basic Information**, then select **Commodity Information**.

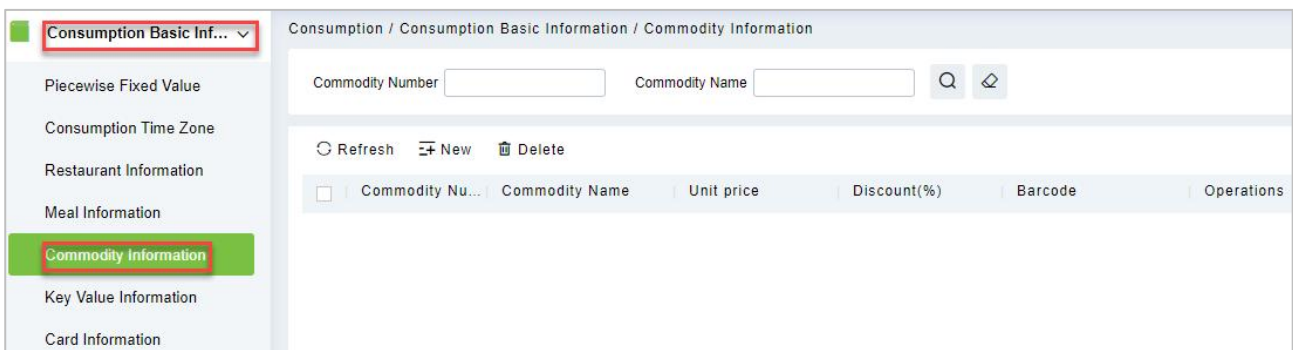

Figure 7-10 Commodity Information

7.1.5.1 New

To add New Commodity Information, Click Consumption > Consumption Basic Information > Commodity Information, then select New.

Figure 7-11 Add New Commodity Information

Fields are as follows:

Parameter	Description
Commodity Number	Enter Commodity number.
Commodity Name	Enter Commodity name.
Unit Price	Enter unit price as required.
Discount	Set Discount.
Barcode	Enter the barcode.

Table 7-2 New Commodity Information

Click **OK** to save and exit.

7.1.5.2 Delete

Click **Consumption > Consumption Basic Information > Commodity Information**, then select Delete.

Figure 7-12 Delete Commodity Information

Click **OK** to save and exit.

7.1.6 Key Value Information

Click **Consumption > Consumption Basic Information**, then select **Key Value Information** to enter the unit value in the consumer device as shown below:

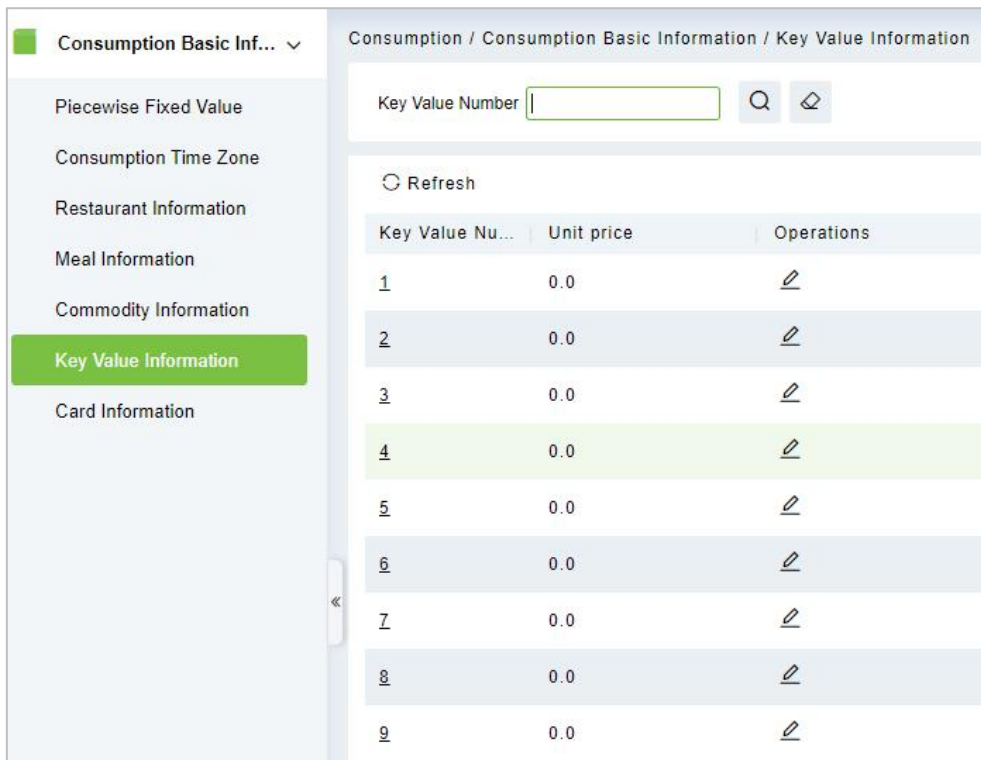

Figure 7-13 Key value information

7.1.7 Card Information

Click **Consumption > Consumption Basic Information**, then select **Card Information**.

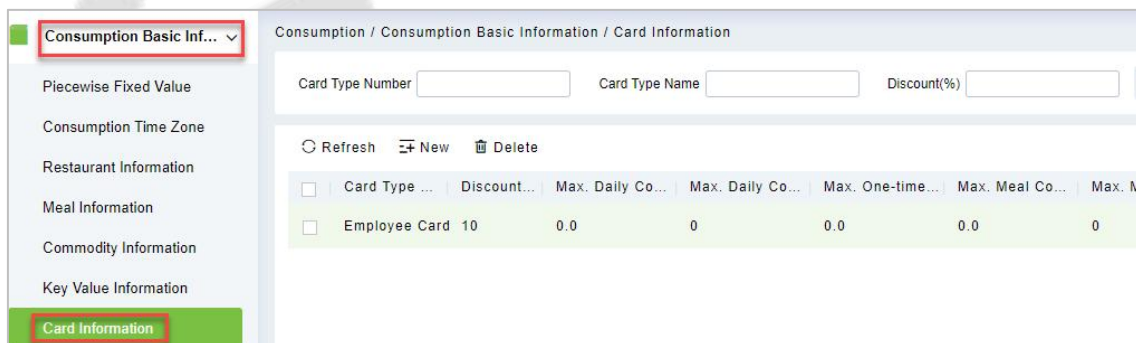

Figure 7-14 Card Information

7.1.7.1 New

Click **Consumption > Consumption Basic Information > Card Information**, then select **New**.

Figure 7-15 New (Add Card Information)

Parameter	How to set
Card Type Number	A positive integer between 1 and 254, which cannot be repeated.
Card Type Name	Non-special characters, maximum 4 bits.
Maximum amount of daily consumption	The maximum amount consumed every day, the effective range is an integer between 0 and 600, and 0 represents unlimited.
Maximum number of daily consumptions	The maximum number of times consumed every day, the effective range is an integer between 0 and 255, and 0 represents unlimited.
Maximum amount of secondary consumption	The maximum amount of each consumption, the effective range is an integer between 0 and 600, and 0 represents unlimited.
Maximum amount of meal consumption	The maximum amount consumed for each meal every day, the effective range is an integer between 0 and 600, and 0 means unlimited.
Maximum number of meals consumed	The maximum number of times of consumption of each meal every day, the effective range is an integer between 0 and 255, and 0 means unlimited.
Minimum/Maximum Card Balance	Integer ≥ 0 , minimum card balance \leq maximum card balance, and the maximum card balance cannot exceed the upper limit of account balance set by parameter.
Effective use days	Set the effective use days of the account.
Consumption Time Zone	Select the consumption time batch, and the accumulation of effective time periods of the same batch is the total effective consumption time period of the batch.
Available meal	Select the appropriate valid meal range and distribute it to the device. If not, all valid meals will be distributed.
Discount (percentage)	Select the discount percentage, which is an integer between 0 and 100.

Parameter	How to set
Available device	Select the device to be distributed by the household class.
Remarks	Any character, up to 50 characters.

Table 7-3 Add Card Information

Click **OK** to save exit.

7.1.7.2 Delete

Click **Consumption > Consumption Basic Information > Card Information**, then select **Delete**.

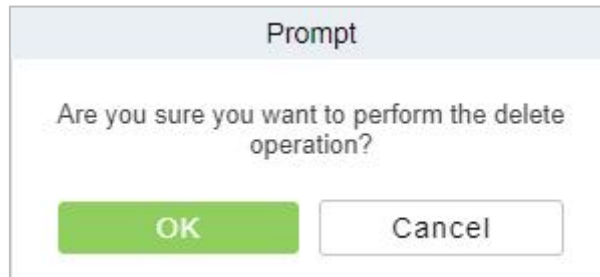

Figure 7-16 Delete Card Information

7.2 Consumption Device

This module is used to manage consumer devices and set basic parameters of the consumer system.

7.2.1 Consumption Device

Click **Consumption > Consumption Device**, then select **Consumption Device**.



Figure 7-17 Consumption Device

7.2.1.1 Delete

Click **Consumption > Consumption Device > Consumption Device**, then select **Delete**.

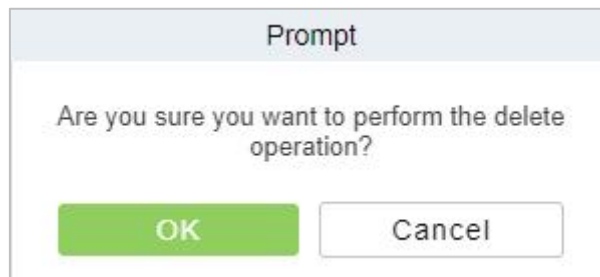

Figure 7-18 Delete Consumption Device

7.2.1.2 Search

Click **Consumption > Consumption Device > Consumption Device**, then select **Search**.

Figure 7-19 Search Consumption Device

Search Consumption Device by entering **Total Progress, IP Address, Device Type, and Serial Number**.

7.2.1.3 Device Control

- **Reboot Device**

It will reboot the selected device.

- **Synchronize Software Data to Device**

Synchronize data from the software to the device

7.2.1.4 View and Get Information

- **Collect All Data**

Click **Consumption > Consumption Device > Consumption Device > View and Get Information** then select **Collect All Data**.

Select a device in the device list below, click and select the device from the list, click to collect all data, and the following dialog box will pop up. According to the operator's needs, check the data that needs to be synchronized. Click Start and wait for the data to sync until the synchronization is complete.

7.2.1.5 Clear Device Data

Click **Consumption > Consumption Device > Consumption Device**, then select **Clear Device Data**.

- **Clear Swipe Card Data**

Click **Consumption > Consumption Device > Consumption Device > Clear Device Data**, then select **Clear Swipe Card Data**.

The operation here is to select the device first, then you can check the type of the card record, you can select all, click **Start** will clear the data of the selected card record, click **Close** will close the current

dialog box, no operation.

- **Clear Consumer Machine Settings**

Click **Consumption** > **Consumption Device** > **Consumption Device** > **Clear Device Data**, then select **Clear Consumer Machine Settings**.

- **Delete Device Command**

Click **Consumption** > **Consumption Device** > **Consumption Device** > **Clear Device Data**, then select **Delete Device Command**.

7.2.2 Consumption Parameter

Parameter setting is the most basic setting in consumption management, and the parameter setting here is taken as the global setting.

Click **Consumption** > **Consumption Device** > **Consumption Device**, then select **Consumption Parameter**.

Figure 7-20 Consumption Parameter

Fields are as follows:

Parameter	Description
Basic Setting	Set Card balance limit for 5 characters, Card Issuing Master Sector, and Card Issuing Sector.
Currency Unit	Enter Symbol and Proportion for Currency Unit.
Card Setting	Set System Password and set Mode.

Table 7-4 Consumption Parameter

Click **OK** to save and exit.

7.3 Consumption Card Management

7.3.1 Card Service

Click **Consumption** > **Consumption Card Management**, then select **Card Service**.

Using this option, you can issue different types of cards and set their usage limits. You can also manage the already existing cards.

The initial interface of this module is shown below:

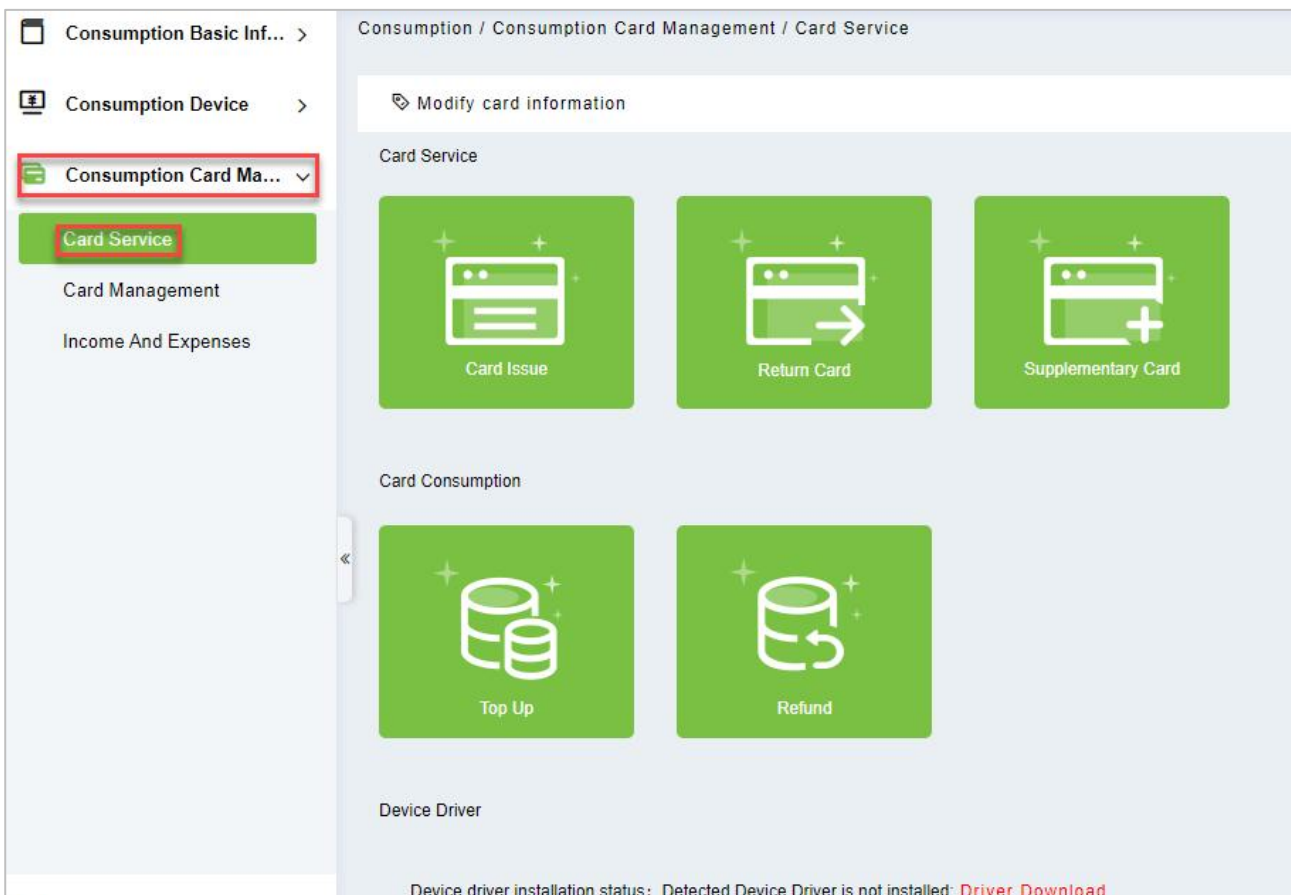

Figure 7-21 Card Service

7.3.1.1 Card Issue

Initialization	
Empty Password*	<input type="checkbox"/>
Card Original Password*	<input type="text"/> (X)

Card Information	
Card Type*	Ordinary Card
Consumer Card Type*	Employee Card
Person Name*	<input type="text"/> (Q)
Card Account*	<input type="text"/>
Amount*	0.00
Card Cost*	0.00
Management Fee	0.00
Excess Password*	123456

Write Card Cancel

Figure 7-22 Card Issue

If the card is previously used before initialization, you can set blank password or keep the original password of the card. After setting the card type and consumer card type in this window, click the icon beside the Person's name field and select the required personnel (you need to add the required personnel in the personnel module before issuing card). Then set the **Card Account, Amount, Card Cost, Management Fee, Excess Password**, click **Write Card** to complete.

Prerequisites:

1. Make sure the required person is already added in the personnel module before issuing card.
2. The card needs to be initialized before issuing the card.

7.3.1.2 Return Card

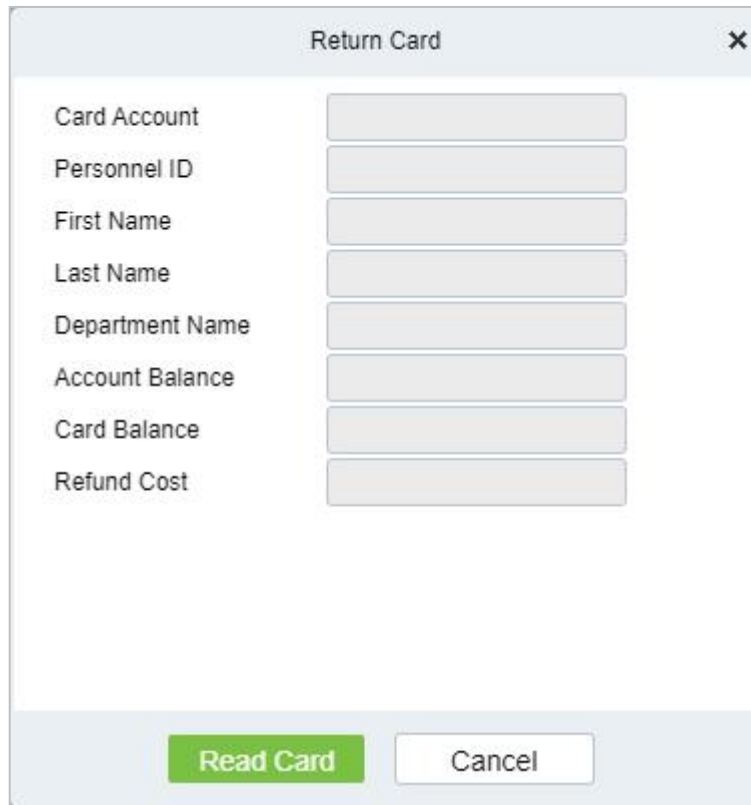
A dialog box titled "Return Card" with a close button (X) in the top right corner. It contains eight input fields for data entry: Card Account, Personnel ID, First Name, Last Name, Department Name, Account Balance, Card Balance, and Refund Cost. At the bottom, there are two buttons: "Read Card" (highlighted in green) and "Cancel".

Field Name	Input Type
Card Account	Text Input
Personnel ID	Text Input
First Name	Text Input
Last Name	Text Input
Department Name	Text Input
Account Balance	Text Input
Card Balance	Text Input
Refund Cost	Text Input

Figure 7-23 Return Card

Return Card operation is performed to stop the card being used further in the consumption software system.

After clicking **Return card**, a pop-up window will give additional information for the operation. Put the card on the card reader, click on the card to read, the card information will be displayed, check the information, and click OK to block or revoke the card.

Prerequisite:

To withdraw a card approval, you must have an issued card.

Enter details for Parameters **Card Account, Personnel ID, First Name, Last Time, Department Name, Account Balance, Card Balance, and Refund Cost.**

Click **Read Card.**

7.3.1.3 Supplementary Card

Prerequisite:

This function is used when a card is reported lost.

Supplementary Card

Initialization

Empty Password*

Card Original Password*

Card Information

Card Type* Ordinary Card

Consumer Card Type* Employee Card

Person Name*

Card Account*

Amount* 0.00

Card Cost* 0.00

Management Fee 0.00

Excess Password* 123456

Please keep all the device in the consumer system online, otherwise it may lead to uneven accounts.

Write Card Cancel

Figure 7-24 Supplementary Card

Click the  search icon beside the Person Name field and select the person who has lost the card. Click to write the card with the same information as the lost card. After the card is issued, the balance and other information in the original card will be written into the new card. (The used card needs to be initialized, and the card can be set to a blank password or a card original password at the initialization interface.)

7.3.1.4 Top Up

Note: Please ensure that all devices in the consumption system are online. Otherwise, the processing result after the above operation cannot be synchronized to other devices. And the original card can still be used for consumption, resulting in the card balance being inconsistent with the actual amount and the account being uneven. Please be careful with Top Up.

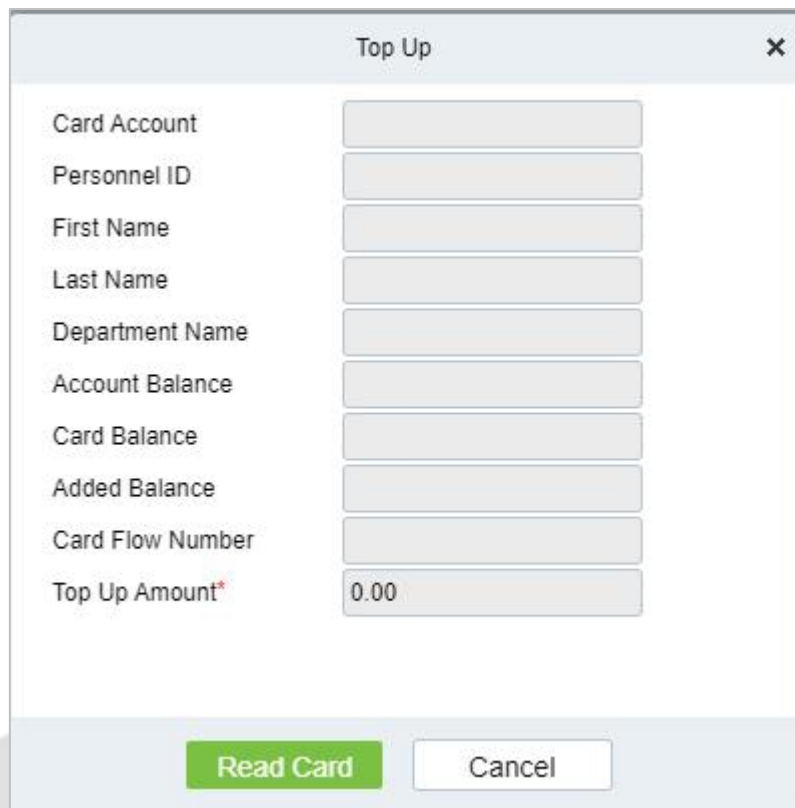

Field	Value
Card Account	
Personnel ID	
First Name	
Last Name	
Department Name	
Account Balance	
Card Balance	
Added Balance	
Card Flow Number	
Top Up Amount*	0.00

Figure 7-25 Top Up

This function is used to add an extra amount to the card balance. Click the top up button to open the Top-up interface. Put the card on the card reader, click on the card to confirm the card information. Enter the amount you need to recharge and then click OK to execute the operation.

7.3.1.5 Refund

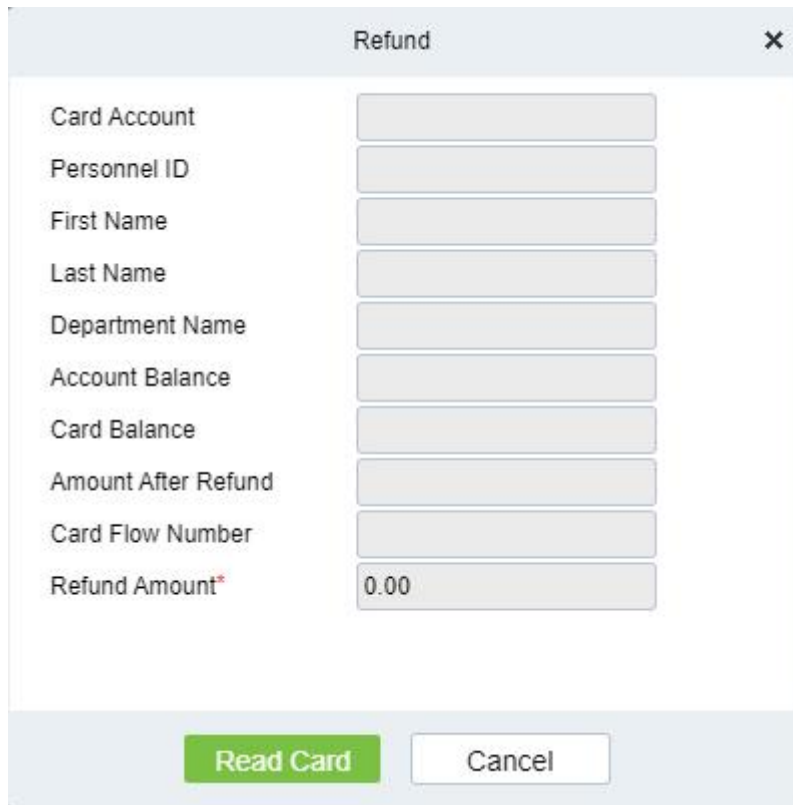

The image shows a 'Refund' dialog box with a title bar containing the word 'Refund' and a close button (X). The dialog contains several input fields: 'Card Account', 'Personnel ID', 'First Name', 'Last Name', 'Department Name', 'Account Balance', 'Card Balance', 'Amount After Refund', 'Card Flow Number', and 'Refund Amount*'. The 'Refund Amount*' field is pre-filled with '0.00'. At the bottom of the dialog, there are two buttons: a green 'Read Card' button and a white 'Cancel' button.

Figure 7-26 Refund

Refund operation is used to return a specified amount to the card. Click the refund button to open the refund interface, put the card on the card reader, click on the Read card to confirm the card information. Enter the amount you need to refund and click OK to execute the operation.

7.3.2 Card Management

Click **Consumption > Consumption Card Management**, then select **Card Management**.

This function is used to perform two operations; **Logout Management Card, Non-Card Return Card, and Export**. And on this interface, you can also view the card information that has been issued till date.

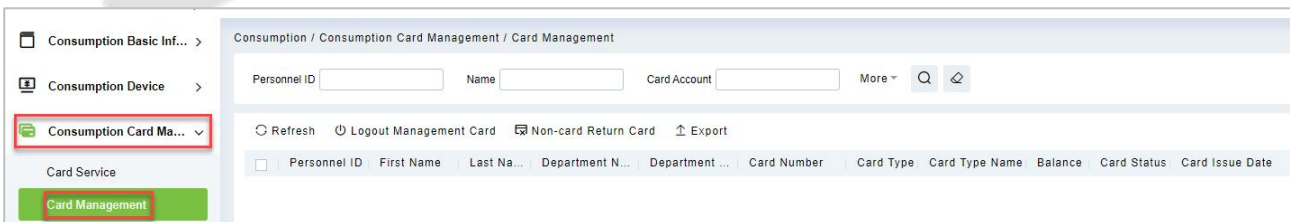

Figure 7-27 Card Management

7.3.2.1 Logout Management Card

This function is used to log out the management and the operation card. After the logout operation, the management card or operation card will be invalid.

Click **Consumption > Consumption Card Management > Card Management**, then select **Logout Management Card**.

7.3.2.2 Non-card Return Card

Click **Consumption > Consumption Card Management > Card Management**, then select Non-card Return Card.

Click **Non-card return card**, select the desired refund option and click **OK**. If the card is eligible for the refund, the amount will be refunded to the card and a refund record will be generated in the system.

The card will not be used in this consumer system after the card is not returned.

Note: Non-card return card Please ensure that all devices in the consumption system are online before operation. Otherwise, the processing result after operation may not be synchronized to other devices in time. The card can still be consumed, resulting in the card balance being inconsistent with the actual amount and unbalanced situation. Please be careful with this!

7.3.2.3 Export

Click **Consumption > Consumption Card Management > Card Management**, then select **Export**.

It exports the current report data.

Note: The report loss/resume card operation is performed in the card management in the **Personnel Module**.

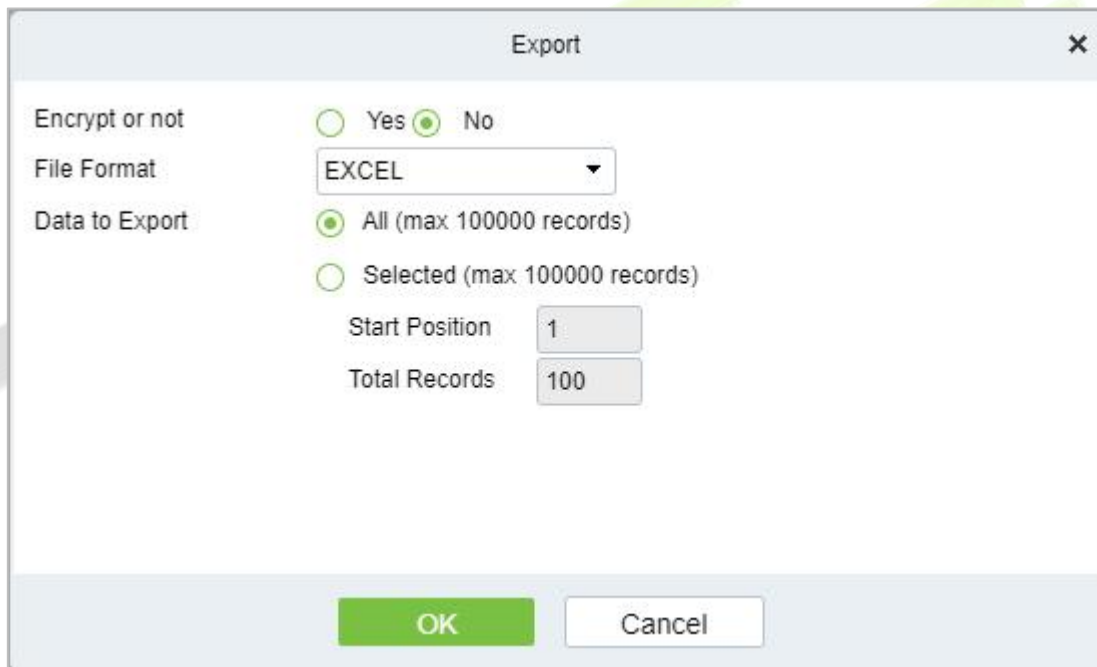

Figure 7-28 Export

7.3.3 Income and Expenses

This function will show all the payments and due amount data of all the cards in the consumption system.

Click **Consumption > Consumption Card Management**, then select **Income and Expenses**.



Figure 7-29 Income and Expenses

7.3.3.1 Export

Click **Consumption > Consumption Card Management > Income and Expenses**, then select **Export**.

This feature allows you to export consumption details in EXCEL, PDF, CSV format files.

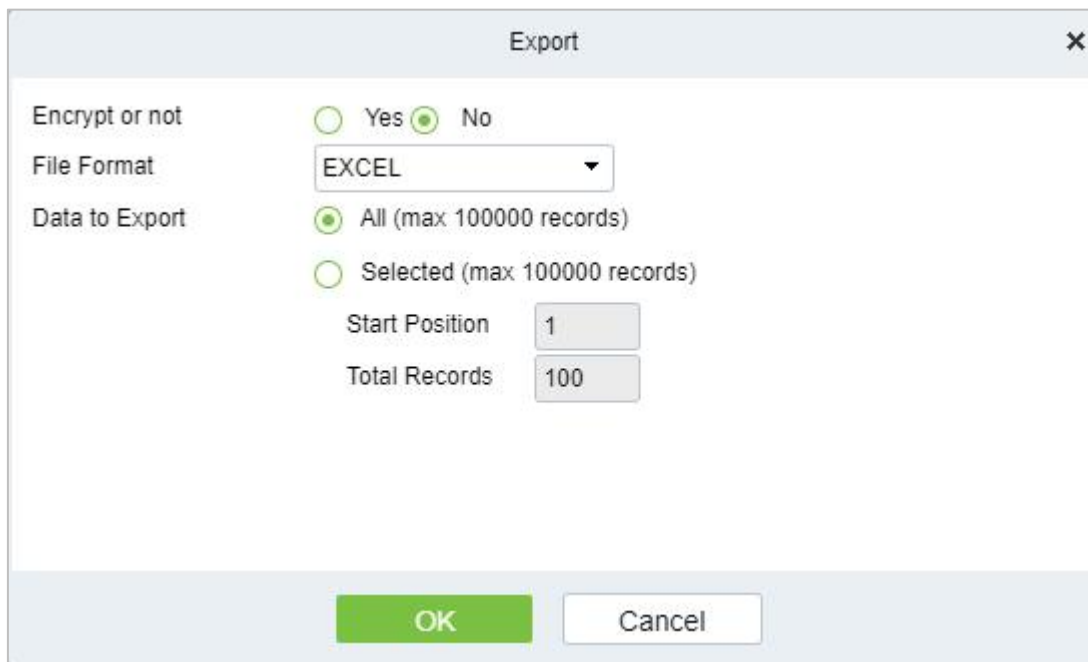

Figure 7-30 Export

7.4 Consumption Detail

Click **Consumption**, then select **Consumption Detail**.

7.4.1 Consumption Detail Report

Click **Consumption > Consumption Detail**, then select **Consumption Detail Report**.

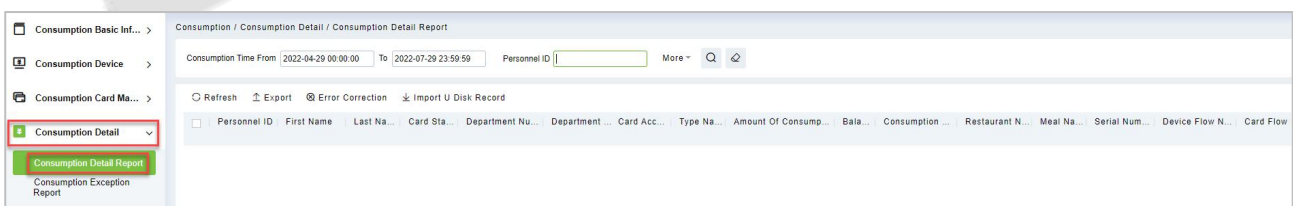

Figure 7-31 Consumption Detail Report

7.4.1.1 Export

Click **Consumption > Consumption Detail > Consumption Detail Report**, then select **Export**.

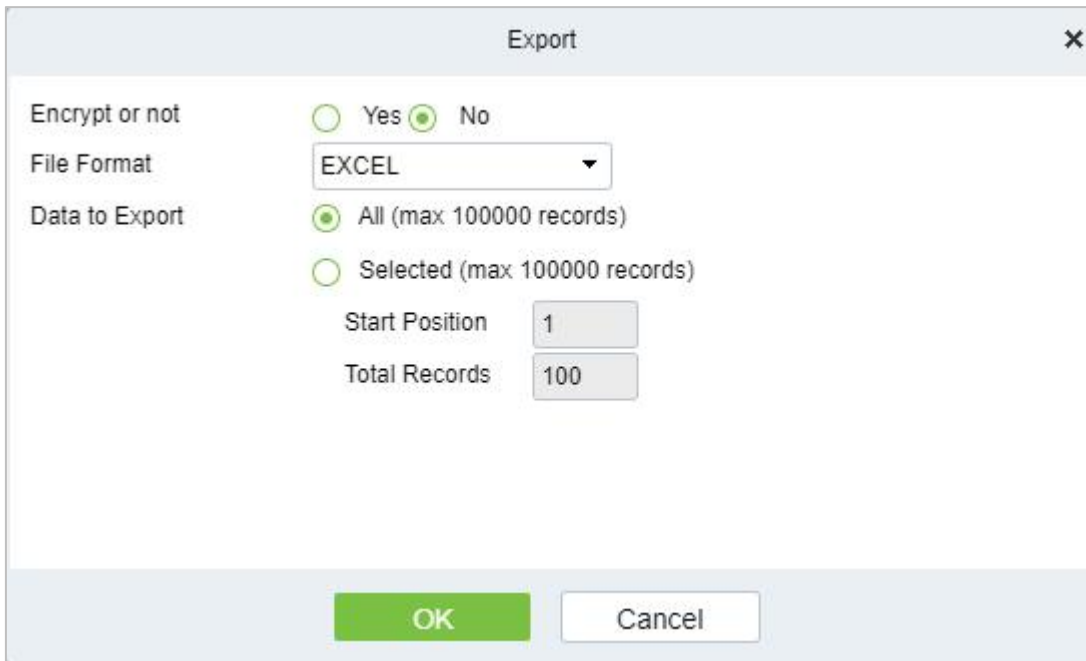

Figure 7-32 Export

7.4.1.2 Error Correction

Click **Consumption > Consumption Detail > Consumption Detail Report**, then select **Error Correction**.

7.4.1.3 Import U Disk Record

Click **Consumption > Consumption Detail > Consumption Detail Report**, then select **Import U Disk Record**.

If the equipment consumption record is found inconsistent with the software, you can export the consumption records of the machine

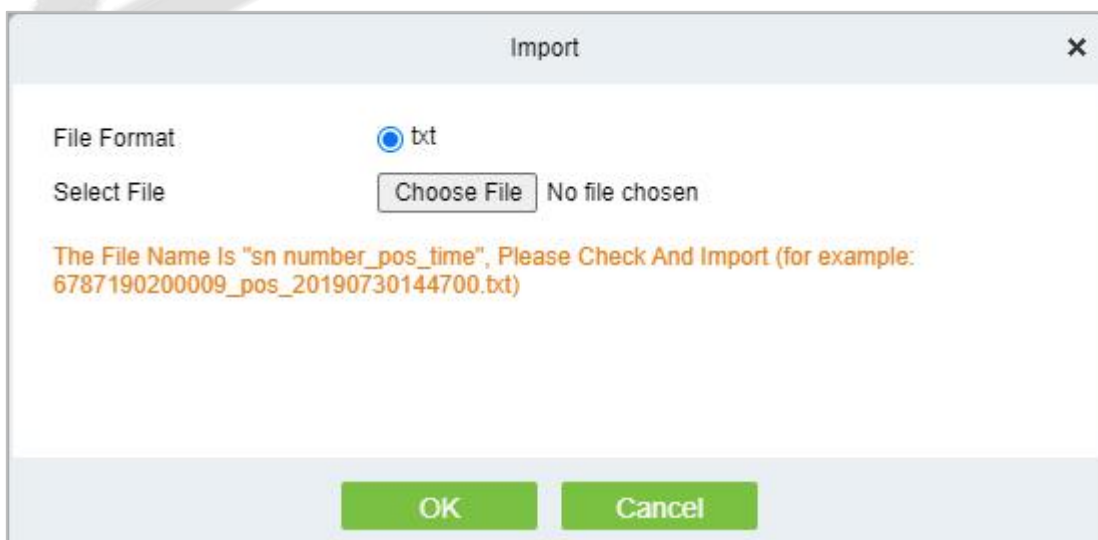

Figure 7-33 Import U Disk Record

7.4.2 Consumption Exception Report

Click **Consumption > Consumption Detail**, then select **Consumption Exception Report**.

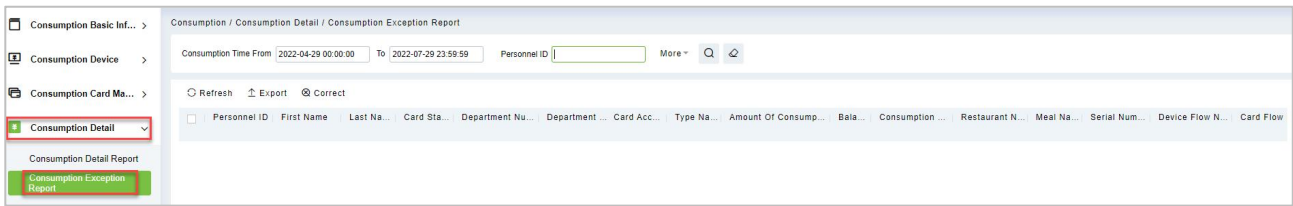

Figure 7-34 Consumption Exception Report

7.4.2.1 Export

Click **Consumption > Consumption Detail**, then select **Consumption Exception Report**.

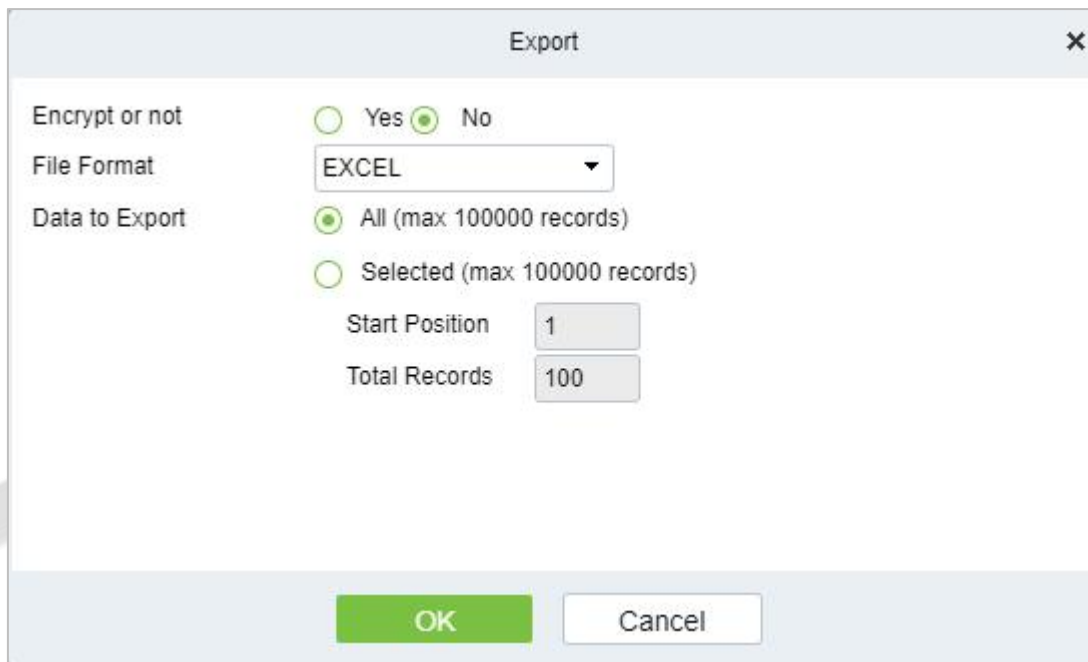

Figure 7-35 Export Consumption Exception Report

7.5 Manual Supplement

It is used to enter some consumptions record details manually in the system.

Note: Before performing this operation, you need to have the relevant operation card.

Click **Consumption**, then select **Manual Supplement**.

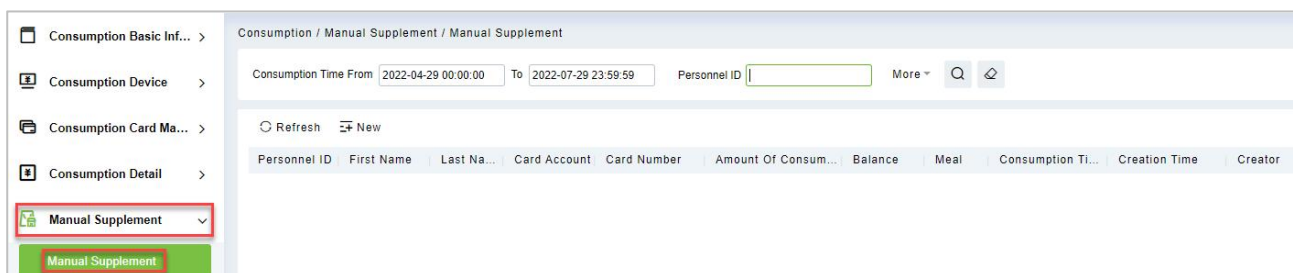

Figure 7-36 Manual Supplement

7.5.1 Manual Supplement

Click **Consumption** > **Manual Supplement**, then select **Manual Supplement**.

You need to cross-check the relevant information of the card. When the user puts the relevant card into the card reader, click on read card to read the detailed data such as the Card Account, Card Number, First Name, Last Name, Personnel ID, Balance, Card Flow Number, Meal, Available Device, Consumption Time, and Amount of Consumption.

The 'New' dialog box contains the following fields and controls:

- Card Account: Text input field
- Card Number: Text input field
- First Name: Text input field
- Last Name: Text input field
- Personnel ID: Text input field
- Balance: Text input field
- Card Flow Number: Text input field
- Meal*: Dropdown menu
- Available Device*: Dropdown menu
- Consumption Time*: Text input field
- Amount Of Consumption*: Text input field with '0' pre-filled
- Buttons: 'Read Card' (green) and 'Cancel' (white)

Figure 7-37 New (Add new Manual supplement)

7.6 Subsidy

Click **Consumption**, then select **Subsidy**. To enter the subsidy page, you can perform different function related to subsidy.

Note: Before the subsidy operation, you need to add personnel in the **Personnel** module.

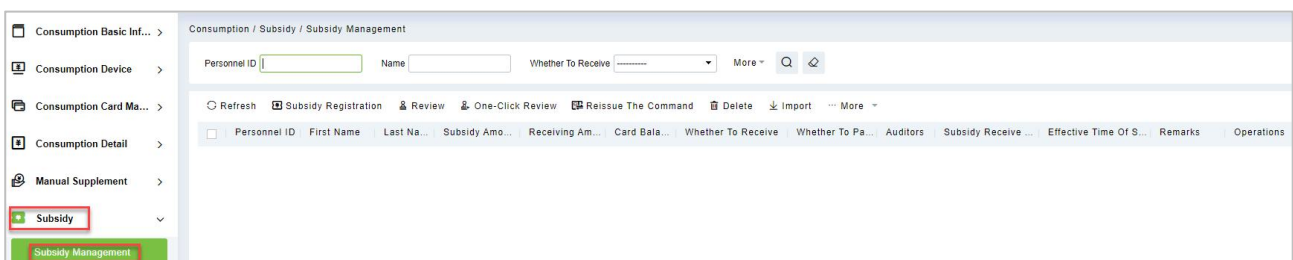

Figure 7-38 Subsidy

7.6.1 Subsidy Registration

Click **Consumption > Subsidy > Subsidy Management**, then select **Subsidy Registration**.

Figure 7-39 Subsidy Registration

Fields are as follows:

Parameter	Description
Personnel ID	Enter Personnel ID.
Subsidy Amount	Enter Subsidy amount.
Effective Time OF Subsidy	Mention Effective time of Subsidy.
Remarks	Mention remarks if any.

Table 7-5 Subsidy Registration

Click **OK** to save and exit.

7.6.2 One- Click Review

Click **Consumption > Subsidy > Subsidy Management**, then select **One- Click Review**.

This function is mainly to review the unapproved subsidies in the system and will not deal with the subsidy records that have been approved. During the review process, if the unapproved subsidy cannot be approved for some reason (such as the user has already returned the card), the subsidy will not be processed.

Figure 7-40 One-Click Review

7.6.3 Review

Click **Consumption > Subsidy > Subsidy Management**, then select **Review**.

This function is mainly to review the audit. Before performing audit, you need to select the subsidy (select in the multi-select box). After clicking the review, an audit dialog box will pop up. The dialog box will display the person number and name as selected by the user.

7.6.4 Reissue the Command

Click **Consumption > Subsidy > Subsidy Management**, then select **Reissue the Command**.

This function is primarily used to re-issue the subsidy to the subsidy machine. Select the required subsidy(s), then click Reissue the command. The dialog box will display the person number and name selected by the user, click OK to reissue the subsidy order to the subsidy machine.

7.6.5 Delete

Click **Consumption > Subsidy > Subsidy Management**, then select **Delete**.

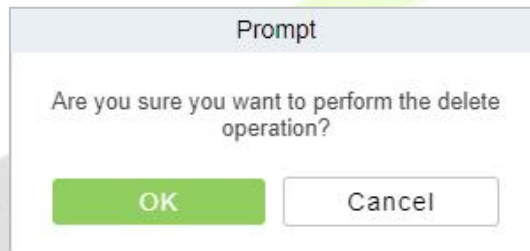

Figure 7-41 Delete Subsidy

7.6.6 Import

Click **Consumption > Subsidy > Subsidy Management**, then select **Import**.

This function is used to import subsidies in batches.

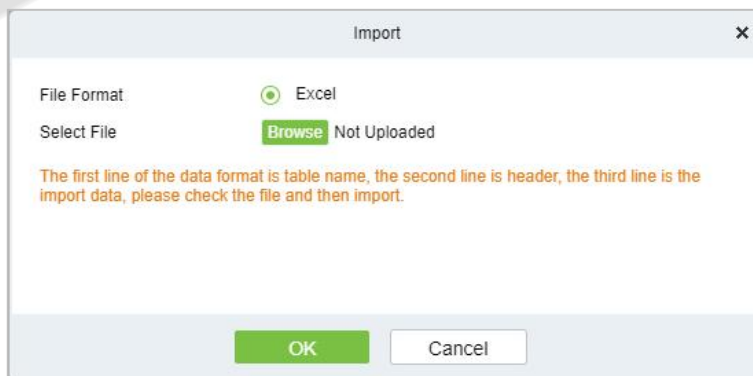

Figure 7-42 Import Subsidy

7.6.7 More

Click **Consumption > Subsidy > Subsidy Management**, then select **More**.

In **More** you can operate options like **Export** and **Download Template**.

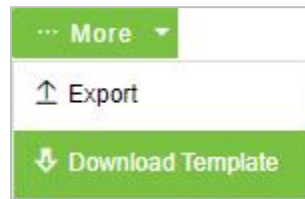

Figure 7-43 More

7.6.8 Export

Click **Consumption > Subsidy > Subsidy Management > More**, then select **Export**.

This function is used to export the queried subsidies.

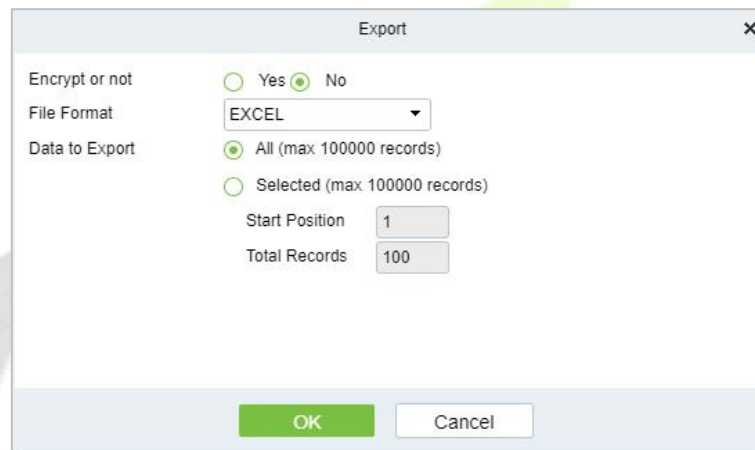

Figure 7-44 Export

7.6.9 Download Template

Click **Consumption > Subsidy > Subsidy Management > More**, then select **Download Template**.

7.7 Consumption Report

Click **Consumption**, then select **Consumption Report**.

The statistical report consists of 9 modules: **Issue Card Report**, **Top Up Report**, **Refund Report**, **Subsidy Report**, **Report of Return Card**, **Card Cost Report**, **Card Balance Report**, **Non-Card Return Card Report**, and **Report of Resume the Card**.

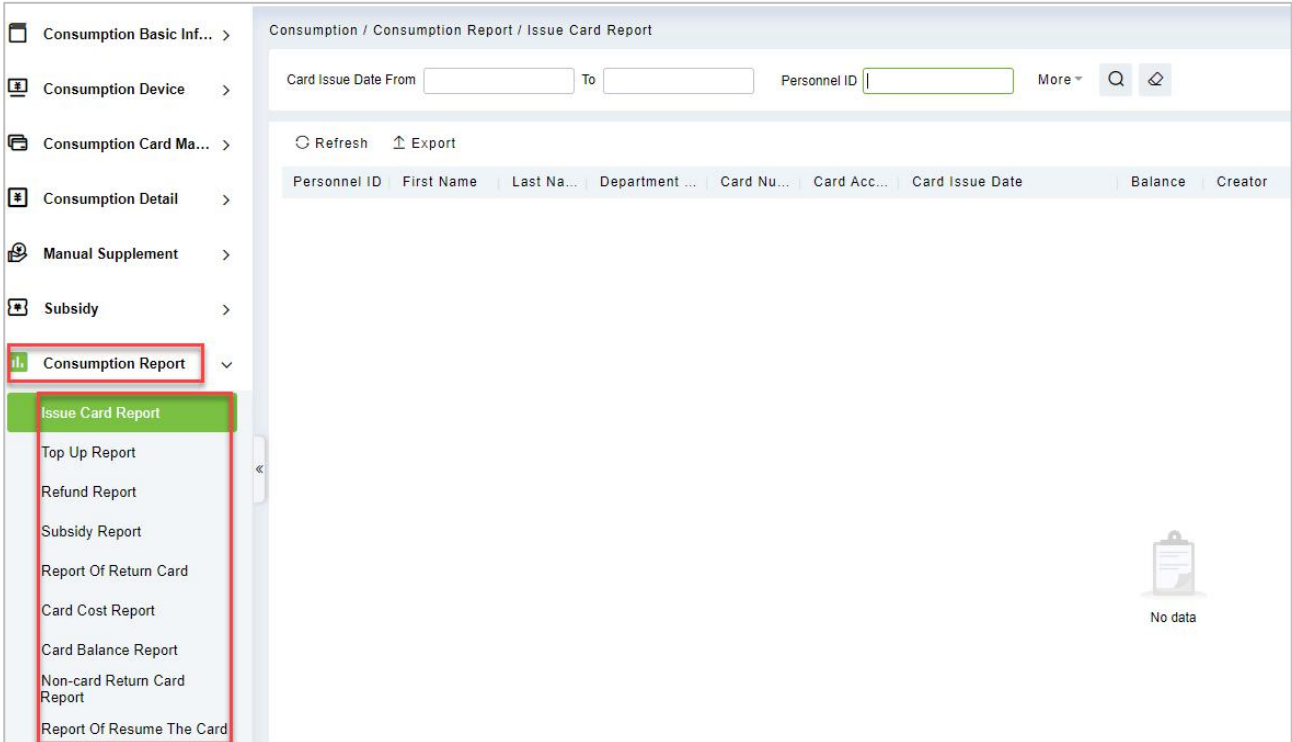

Figure 7-45 Consumption Report

7.7.1 Issue Card Report

Click **Consumption** > **Consumption Report**, then select **Issue Card Report**.

7.7.1.1 Export

Click the **Export** button at the top of the list to open an export dialog box, as shown below. Click **OK** to export the data according to the query conditions and export conditions. The export format type can be selected as Excel, PDF, or CSV files.

Click **Consumption** > **Consumption Report** > **Issue Card Report**, then select **Export**.

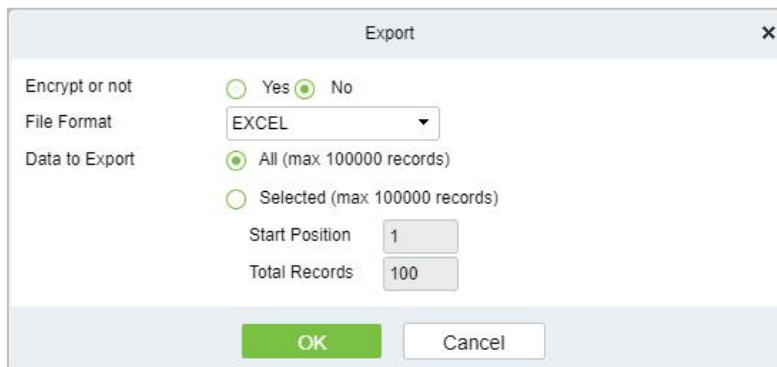

Figure 7-46 Export

7.7.2 Top Up Report

Click **Consumption > Consumption Report**, then select **Top Up Report**.

7.7.2.1 Export

Click the **Export** button at the top of the list to open an export dialog box, as shown below. Click **OK** to export the data according to the query conditions and export conditions. The export format type can be selected as Excel, PDF, or CSV files.

Click **Consumption > Consumption Report > Top UP Report**, then select **Export**.

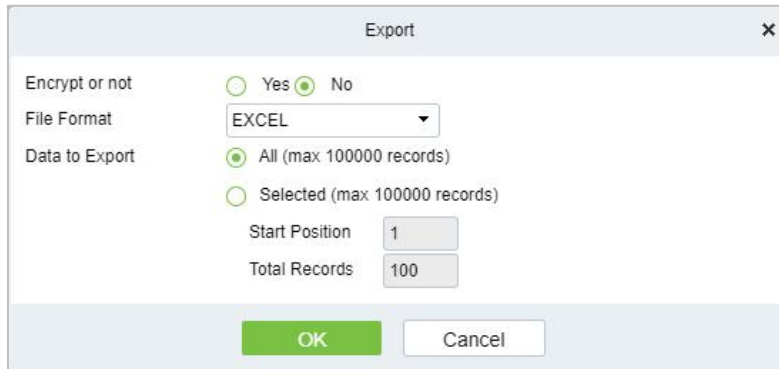

Figure 7-47 Export

7.7.3 Refund Report

Click **Consumption > Consumption Report**, then select **Refund Report**.

7.7.3.1 Export

Click the **Export** button at the top of the list to open an export dialog box, as shown below. Click **OK** to export the data according to the query conditions and export conditions. The export format type can be selected as Excel, PDF, or CSV files.

Click **Consumption > Consumption Report > Refund Report**, then select **Export**.

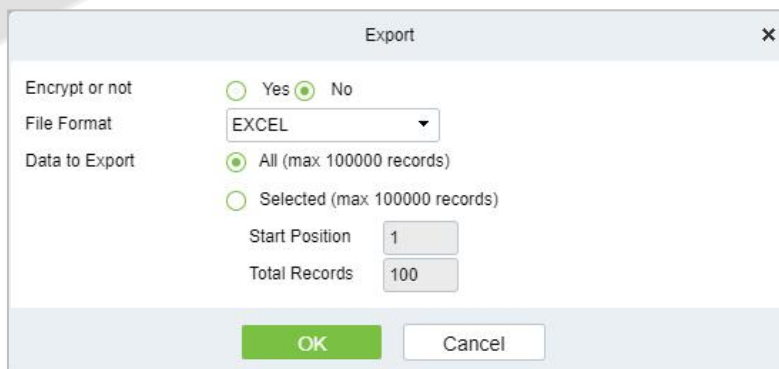

Figure 7-48 Export Refund Report

7.7.4 Subsidy Report

Click **Consumption > Consumption Report**, then select **Subsidy Report**.

7.7.4.1 Export

Click the **Export** button at the top of the list to open an export dialog box, as shown below. Click **OK** to export the data according to the query conditions and export conditions. The export format type can be selected as Excel, PDF, or CSV files.

Click **Consumption > Consumption Report > Subsidy Report**, then select **Export**.

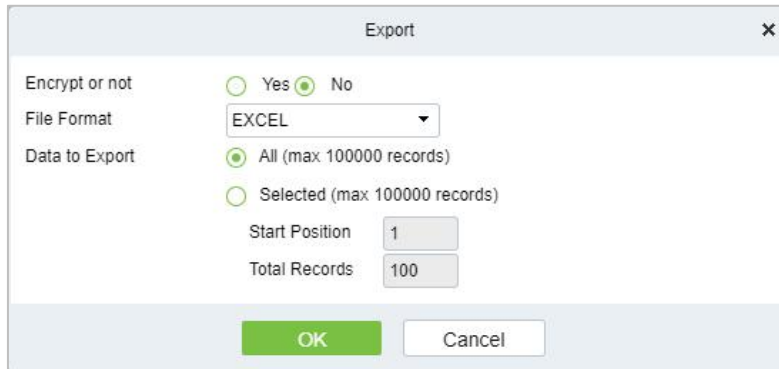

Figure 7-49 Export Subsidy Report

7.7.5 Report of Return Card

Click **Consumption > Consumption Report**, then select **Report of Return Card**.

7.7.5.1 Export

Click the **Export** button at the top of the list to open an export dialog box, as shown below. Click **OK** to export the data according to the query conditions and export conditions. The export format type can be selected as Excel, PDF, or CSV files.

Click **Consumption > Consumption Report > Report of Return Card**, then select **Export**.

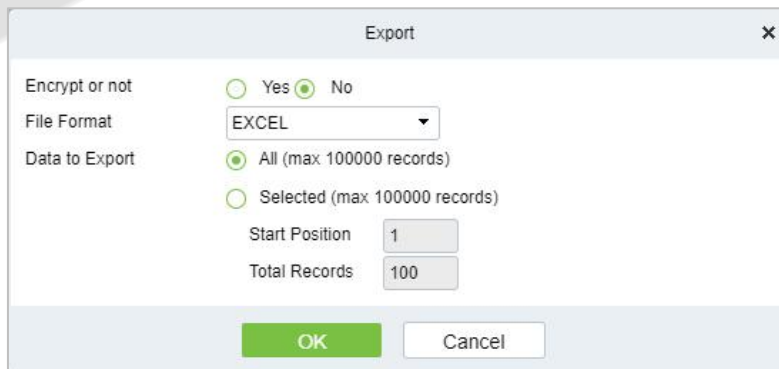

Figure 7-50 Export Report of Return Card

7.7.6 Card Cost Report

Click **Consumption > Consumption Report**, then select **Card Cost Report**.

7.7.6.1 Export

Click the **Export** button at the top of the list to open an export dialog box, as shown below. Click **OK** to export the data according to the query conditions and export conditions. The export format type can be selected as Excel, PDF, or CSV files.

Click **Consumption > Consumption Report > Card Cost Report**, then select **Export**.

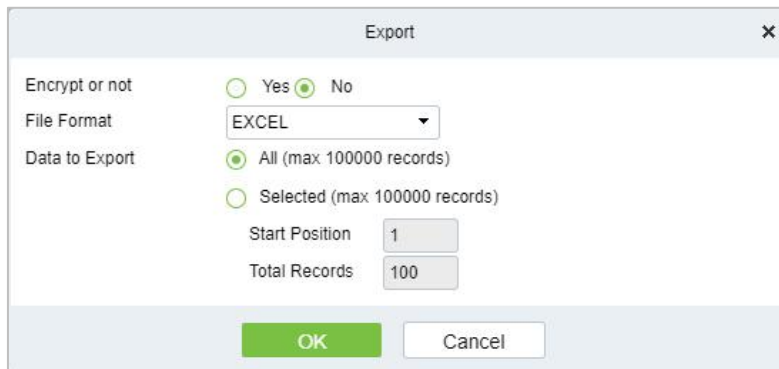

Figure 7-51 Export Card Cost Report

7.7.7 Card Balance Report

Click **Consumption > Consumption Report**, then select Card balance Report.

7.7.7.1 Export

Click the **Export** button at the top of the list to open an export dialog box, as shown below. Click **OK** to export the data according to the query conditions and export conditions. The export format type can be selected as Excel, PDF, or CSV files.

Click **Consumption > Consumption Report > Card Balance Report**, then select **Export**.

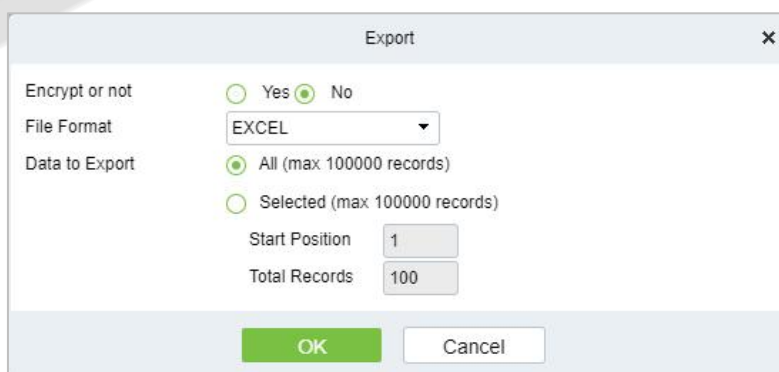

Figure 7-52 Export Card Balance Report

7.7.8 Non-Card Return Card Report

Click **Consumption > Consumption Report**, then select **Non-Card Return Card Report**.

7.7.8.1 Export

Click the **Export** button at the top of the list to open an export dialog box, as shown below. Click **OK** to export the data according to the query conditions and export conditions. The export format type can be selected as Excel, PDF, or CSV files.

Click **Consumption > Consumption Report > Non- Card Return Card Report**, then select **Export**.

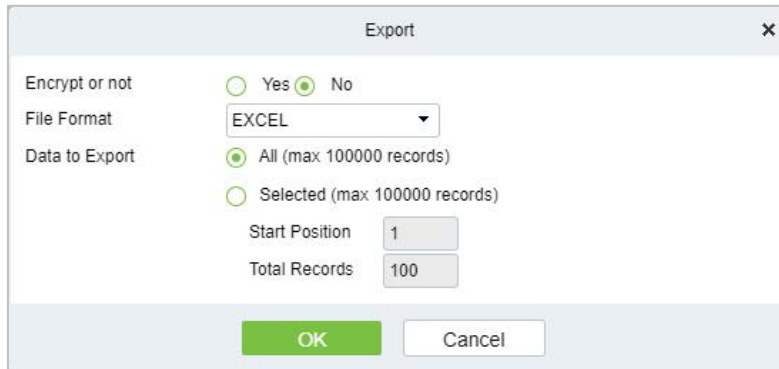

Figure 7-53 Export Non-Card Return Card Report

7.7.9 Report of Resume the Card

Click **Consumption > Consumption Report**, then select **Report of Resume the Card**.

7.7.9.1 Export

Click the **Export** button at the top of the list to open an export dialog box, as shown below. Click **OK** to export the data according to the query conditions and export conditions. The export format type can be selected as Excel, PDF, or CSV files.

Click **Consumption > Consumption Report > Report og Resume the Card**, then select **Export**.

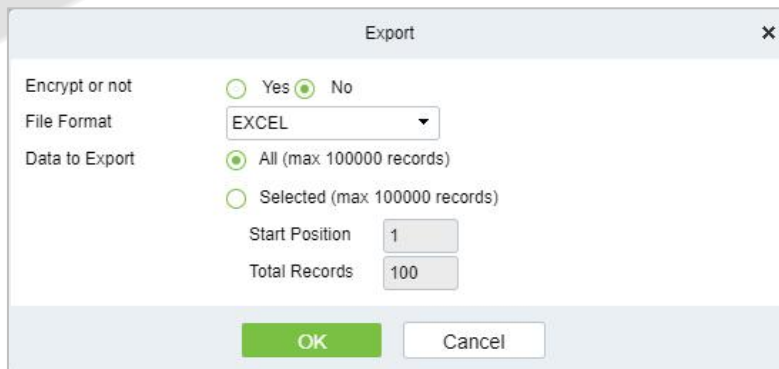

Figure 7-54 Export Report of Resume the Card

7.8 Consumption Statistics

The statistical report contains the statistical information of consumption system module.

It includes **Personal Consumption Report, Department Summary, Restaurant Summary, Device Summary, Income and Expenses Report, and Meal Summary.**

Click **Consumption**, then select **Consumption Statistics**.

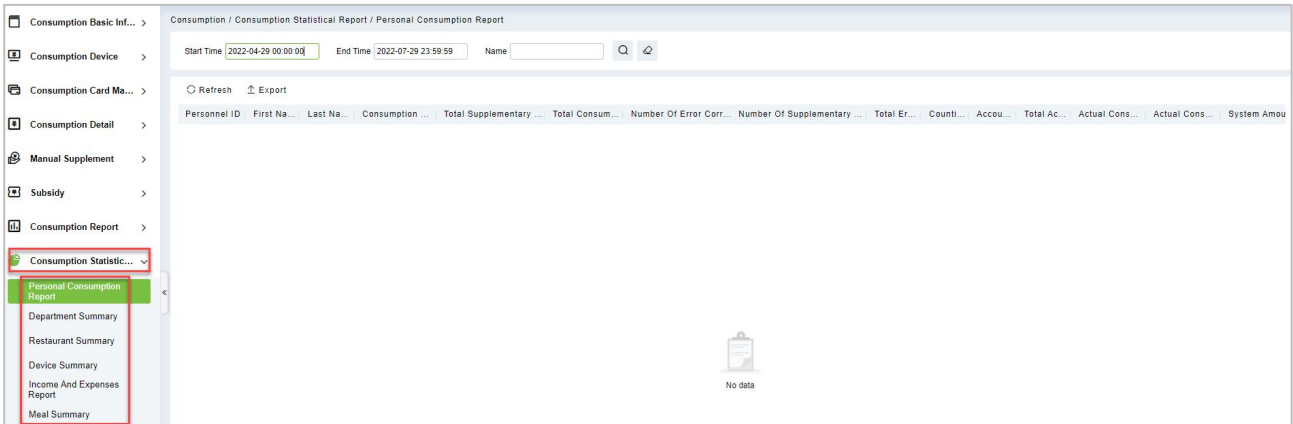

Figure 7-55 Consumption Statistics

7.8.1 Personal Consumption Report

Click **Consumption > Consumption Statistics** then select **Personal Consumption Report**.

7.8.1.1 Export

Click the **Export** button at the top of the list to open an export dialog box, as shown below. Click **OK** to export the data according to the query conditions and export conditions. The export format type can be selected as Excel, PDF, or CSV files.

Click **Consumption > Consumption Statistics > Personal Consumption Report**, then select **Export**.

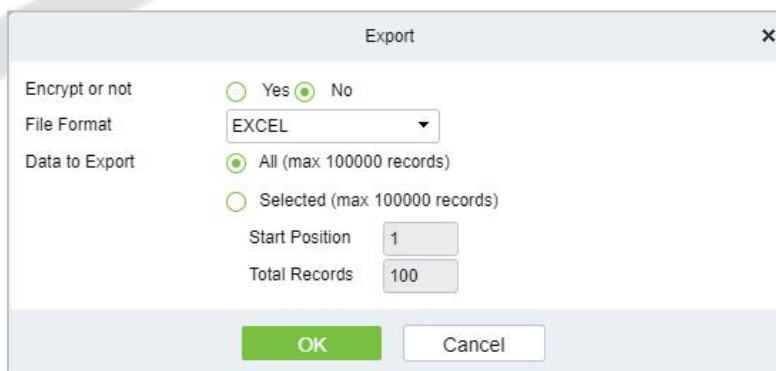

Figure 7-56 Export Personal Consumption Report

7.8.2 Department Summary

Click **Consumption > Consumption Statistics** then select **Department Summary**.

7.8.2.1 Export

Click the **Export** button at the top of the list to open an export dialog box, as shown below. Click **OK** to export the data according to the query conditions and export conditions. The export format type can be selected as Excel, PDF, or CSV files.

Click **Consumption > Consumption Statistics > Department Summary**, then select **Export**.

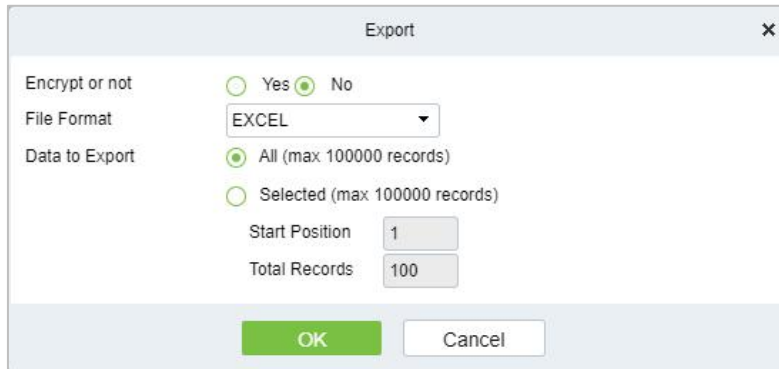

Figure 7-57 Export Department summary

7.8.3 Restaurant Summary

Click **Consumption > Consumption Statistics** then select **Restaurant Summary**.

7.8.3.1 Export

Click the **Export** button at the top of the list to open an export dialog box, as shown below. Click **OK** to export the data according to the query conditions and export conditions. The export format type can be selected as Excel, PDF, or CSV files.

Click **Consumption > Consumption Statistics > Restaurant Summary**, then select **Export**.

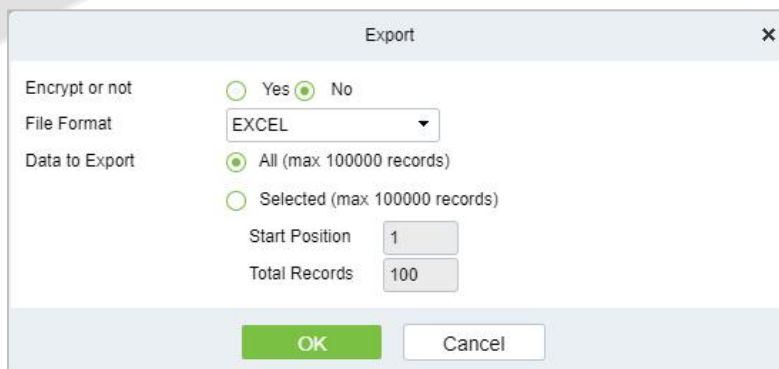

Figure 7-58 Export Restaurant Summary

7.8.4 Device Summary

Click **Consumption > Consumption Statistics** then select **Device Summary**.

7.8.4.1 Export

Click the **Export** button at the top of the list to open an export dialog box, as shown below. Click **OK** to export the data according to the query conditions and export conditions. The export format type can be selected as Excel, PDF, or CSV files.

Click **Consumption > Consumption Statistics > Device Summary**, then select **Export**.

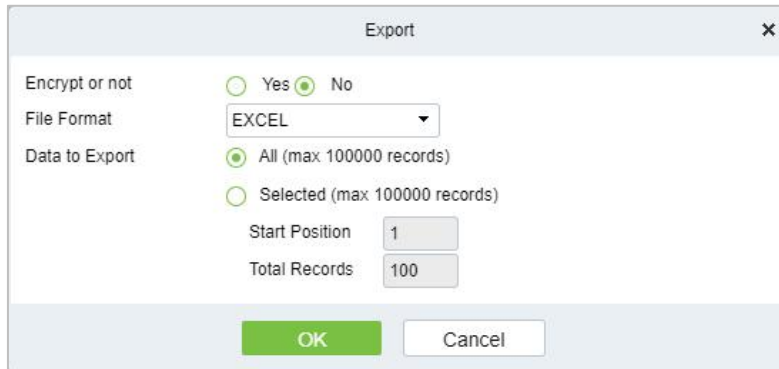

Figure 7-59 Export Device Summary

7.8.5 Income and Expenses Report

Click **Consumption > Consumption Statistics** then select **Income and Expenses Report**.

7.8.5.1 Export

Click the **Export** button at the top of the list to open an export dialog box, as shown below. Click **OK** to export the data according to the query conditions and export conditions. The export format type can be selected as Excel, PDF, or CSV files.

Click **Consumption > Consumption Statistics > Income and Expenses Report**, then select **Export**.

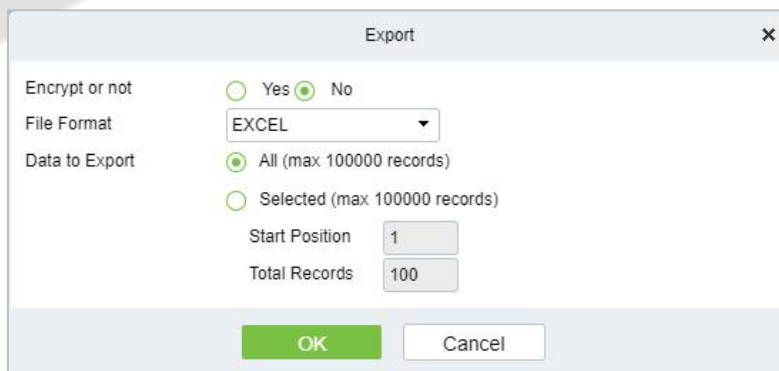

Figure 7-60 Income and Expenses Report

7.8.6 Meal Summary

Click **Consumption > Consumption Statistics** then select **Meal Summary**.

7.8.6.1 Export

Click the **Export** button at the top of the list to open an export dialog box, as shown below. Click **OK** to export the data according to the query conditions and export conditions. The export format type can be selected as Excel, PDF, or CSV files.

Click **Consumption > Consumption Statistics > Meal Summary**, then select **Export**.

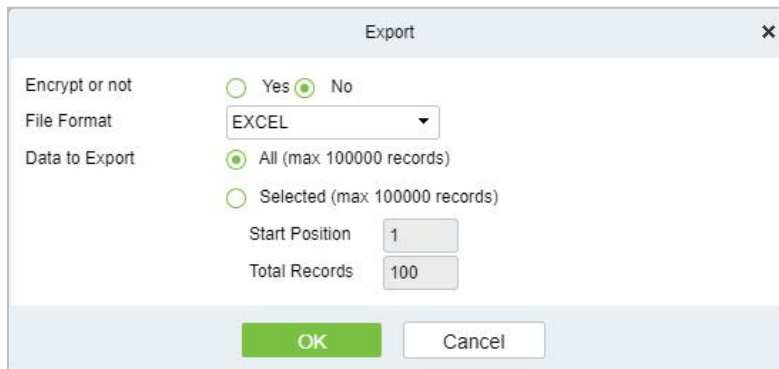

The screenshot shows an 'Export' dialog box with the following configuration:

- Encrypt or not: Yes No
- File Format: EXCEL
- Data to Export: All (max 100000 records) Selected (max 100000 records)
- Start Position: 1
- Total Records: 100

Buttons: OK, Cancel

Figure 7-61 Export Meal Summary

8 Elevator Control Management

8.1 Operation Scenario

Elevator control management, also known as elevator access control management, realizes the unified management of personnel entering and leaving the elevator through the configuration of floors and personnel authority groups.

Elevator control solves the elevator floor arrival authority of registered personnel, that is, in a certain period, on certain floors, authorized personnel can be verified and passed.

8.2 Operation Flow

Introduce the configuration process of Elevator control management business.

The business configuration process of Elevator control management business is shown in Figure 8-1

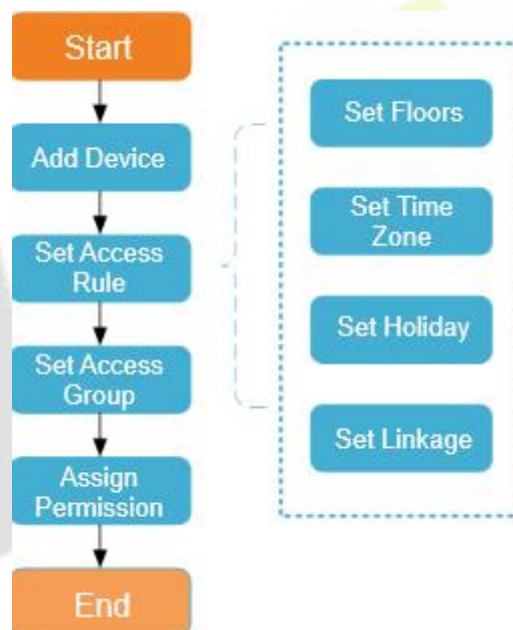

Figure 8-1 Elevator Control Configuration Flow

8.3 Elevator Device

There are two ways to add Elevator Devices.

8.3.1 Manually Add Elevator Control Device (Device)

This paper introduces the configuration Steps of adding **Access Control** device in platform.

Through the new way, the Elevator control device is added by TCP/IP communication. After filling in the corresponding information, Click **OK** to complete the addition, which is convenient to operate.

8.3.1.1 Add device (New)

Operating Steps:

Step 1: In the **Elevator Control** module, select "**Elevator Control device > device**".

Step 2: In the device management interface, click the **New** button to pop up the New box.

Step 3: Fill in the corresponding parameter information in the new box. The new box of device is shown in the figures below. Please refer to below table for parameter setting instructions.

Step 4: Click **OK** to complete the operation of adding Elevator control device.

TCP/ IP communication mode

RS485 communication mode

Figure 8-2 Add Elevator Control Configuration Flow

Parameter	How to set
Device Name	Customize the name of this device
Communication Mode	Choose the communication mode of TCP/IP
IP Address	Fill in the IP address of Elevator control device
Communication Port	The default device communication port is 4370
Communication Cipher	Fill in the communication password of the device. If there is no password, it does not need to be filled in, and it can only be added after successful verification. For new factory device and initialized device, the communication password is empty. In order to ensure that the device is not used by others, the user can enter the IP address of the device through the Web page and enter the background to customize the verification password.
Number of Expansion Plates	The Elevator control device can control the expansion of the number of floors
Number of Relays Per Expansion Board	Each expansion board has 16 relays
Region	The device is divided into regions, and the device can be filtered according to the regions during real-time monitoring

Parameter	How to set
Delete Data in Device When Adding	Set whether the original Elevator control event data in the device will be automatically emptied after the device is added.

Table 8-2 Description of Settings for Adding Devices

8.3.1.2 Delete

Step 1: On the **Device** interface, select the required Device from the list.

Step 2: Click **Delete** or click on the  icon to delete the selected Device.

Step 3: Click **Delete**, to ensure and delete the selected Device from the list.

8.3.1.3 Export

You can export all transactions in Excel, PDF, CSV format.

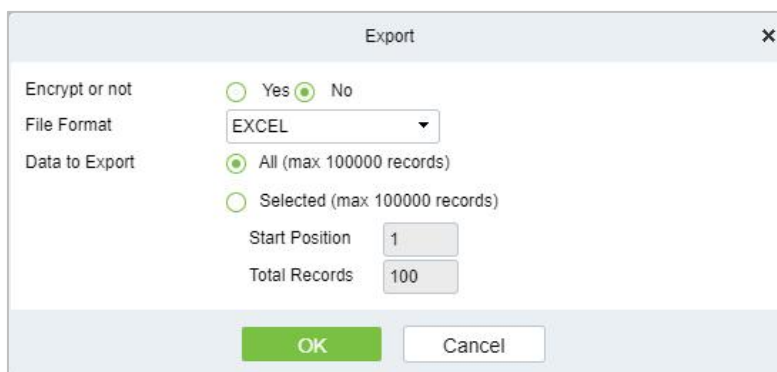

Figure 8-3 Export Elevator Control Configuration Flow

8.3.1.4 Search And Add Elevator Control Device (Search)

This paper introduces the configuration Steps of adding Elevator control device in by searching.

Through the way of searching, the Elevator control device in the local area network is searched, and the Elevator control device that has been searched out is directly added, which is convenient to operate.

Operating Steps:

Step 1: In the **Elevator Control** module, select "**Elevator Control Device > Device**".

Step 2: In the device management interface, click the **Search** button to pop up the search box.

Step 3: Click "**Start Search**" in the search box to display the Elevator control devices that can be added, as shown in Figure 8-4.

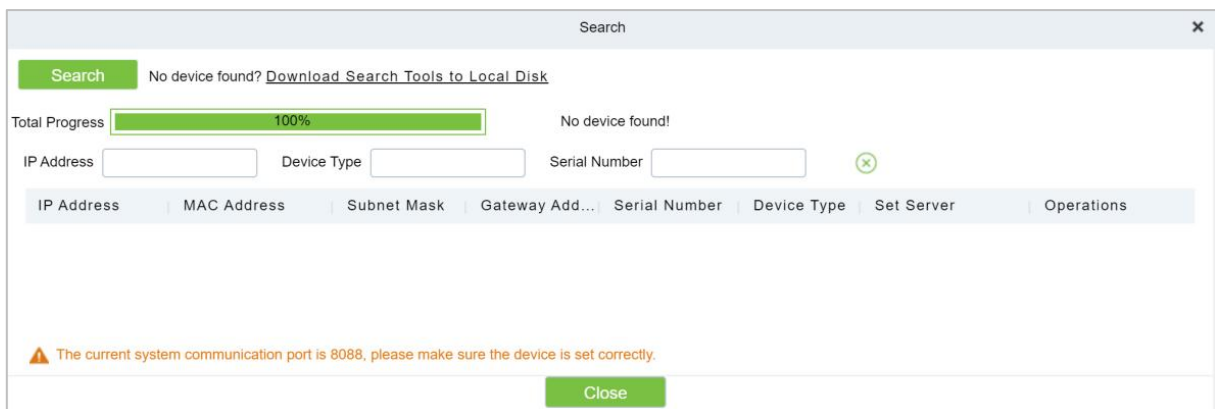

Figure 8-4 Device Search Add Interface

Step 4: Optional: Modify the IP address of Elevator control device and click "**Modify IP Address**". Modifying IP address will restart the device, and the IP address modification will be completed after restarting.

Step 5: For the Elevator control device searched, click the **Add** button in the operation bar to add the device; The device addition settings are shown in Figure 8-5, and the parameter settings are shown in Table 8-1.

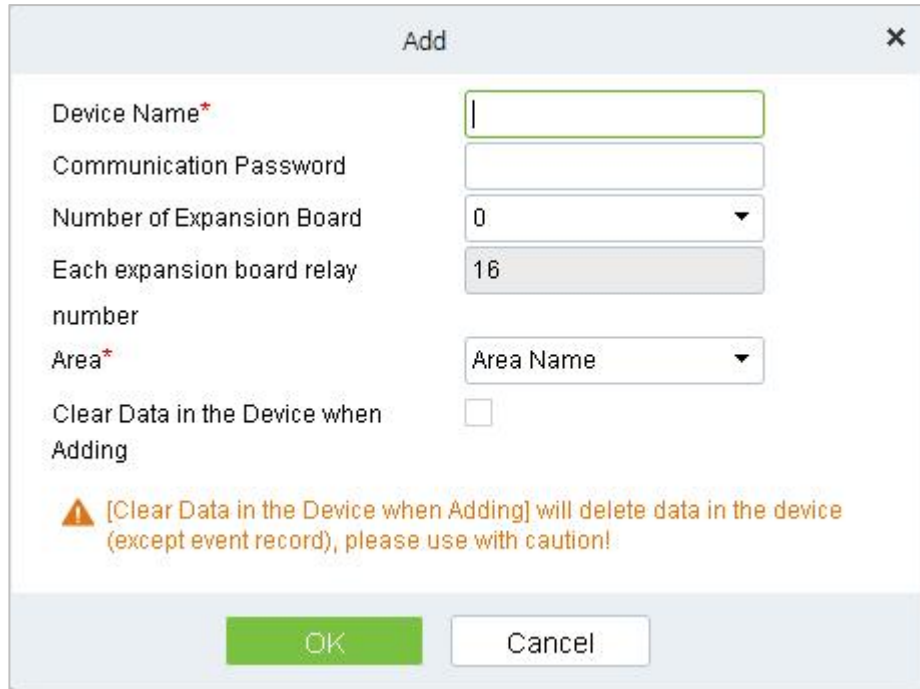

Figure 8-5 Add Interface

Parameter	How to set
Device Name	Customize the name of the device.
Communication Cipher	Fill in the communication password of the device. If there is no password, it does not need to be filled in, and it can only be added after successful verification. For new factory device and initialized device, the communication password is empty. In order to ensure that the device is not used by others, the user can enter the IP address of the device through the Web page and enter the background to customize the verification password.
Number of Expansion Plates	Elevator control device can control the expansion of the number of floors.
Number of Relays Per Expansion Board	Each expansion board has 16 relays.
Region	The device is divided into regions, and the device can be filtered according to the regions during real-time monitoring.
Delete Data in Device When Adding	Set whether the original Elevator control event data in the device will be automatically emptied after the device is added.

Table 8-1 Device Search Added Settings Description

Step 6: Click **OK** to complete the operation of adding Elevator control device.

Step 7: Click **Close** to close the Device Search Add interface.

8.3.1.5 Control

- **Upgrade Firmware**

Tick the device that needs to be upgraded, click **Upgrade firmware** to enter edit interface, then click **Browse** to select firmware upgrade file (named emfw.cfg) provided by Access software, and click **OK** to start upgrading.

⚠ **Note:** The user shall not upgrade firmware without authorization. Contact the distributor before upgrading firmware or upgrade it following the instructions of the distributor. Unauthorized upgrade may affect normal operations.

- **Reboot Device**

It will reboot the selected device.

- **Synchronize Time**

It will synchronize device time with server's current time.

- **Disable/Enable**

Select device, click **Disable/Enable** to stop/start using the device. When communication between the device and the system is interrupted or device fails, the device may automatically appear in disabled status. After adjusting local network or device, click **Enable** to reconnect the device and restore device communication.

- **Synchronize All Data to Devices**

Synchronize data of the system to the device. Select device, click **Synchronize All Data to Devices** and click **OK** to complete synchronization.

8.3.1.6 Set Up

- **Modify IP Address**

Select a device and click **Modify IP address** to open the modification interface. It will obtain a real-time network gateway and subnet mask from the device. (Failed to do so, you cannot modify the IP address). Then enter a new IP address, gateway, and subnet mask. Click **OK** to save and quit. This function is the similar as Modify IP Address Function in Device.

- **Modify Communication Password**

The system will ask for the old communication password before modifying it. After verification, input the new password twice, and click **OK** to modify the communication password.

⚠ **Note:** Communication password shouldn't contain spaces; it is recommended to use a combination of numbers and letters. Communication password setting can improve the device's security. It is recommended to set communication password for each device.

- **Modify RS485 Address**

Only the devices that use RS485 communication and with no DIP Switch can modify RS485 address.

- **Modify the Fingerprint Identification Threshold**

Users can modify the fingerprint identification thresholds in the devices; it ranges from 35 to 70 and it is 55 by default. The system will read the thresholds from the device.

- **Set extended Parameters**

We can set the extended parameters of device like temperature detection and mask detection

8.3.1.7 View/Get

- **Get Device Option**

It gets the common parameters of the device. For example, get the firmware version after the device is updated.

- **Get Personnel Information**

Renew the current number of personnel, fingerprints, finger vein and face templates in the device. The final value will be displayed in the device list.

- **Get Transactions**

Get transactions from the device into the system. Two options are provided for this operation: Get New Transactions and Get All Transactions.

8.3.2 Expanding Board

This introduces the configuration Steps of adding **Expanding Board** device in the platform.

8.3.2.1 Add device (New)

Operating Steps:

Step 1: In the **Elevator Control** module, select "**Elevator Control device > Expanding Board**".

Step 2: In the expanding board interface, click the **New** button to pop up the Newbox.

Step 3: Fill in the corresponding parameter information in the new box. The new box of device is shown in Figure 8-4. Please refer to Table 8-2 for parameter setting instructions.

Step 4: Click **OK** to complete the operation of adding Expanding board interface.

Figure 8-6 Add Expanding Board

8.3.2.2 Delete

Step 1: On the **Expanding Board** interface, select the required Device from the list.

Step 2: Click **Delete** or click on the  icon to delete the selected Device.

Step 3: Click **Delete**, to ensure and delete the selected Device from the list.

8.3.3 Reader

Each elevator device has a reader, the reader information can be set.

Operating Steps:

Click **Elevator Device > Reader**, select a reader name in the reader list:

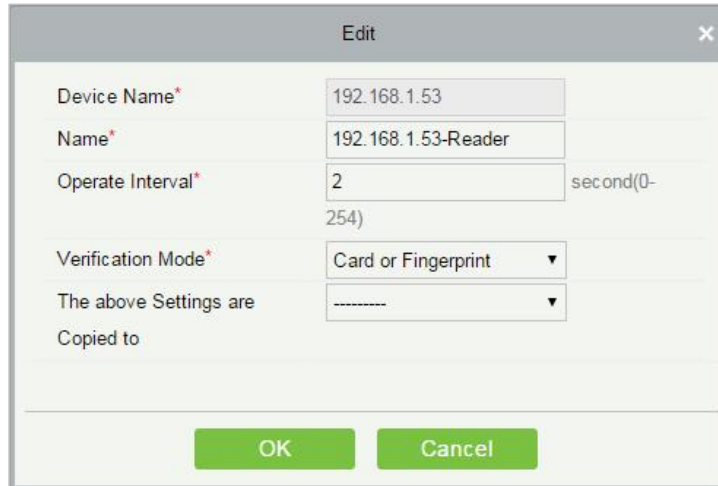

Figure 8-7 Edit Reader interface

Parameter	How to set
Device Name	It is not editable.
Name	The default format is "Device Name - Reader", editable in 30 characters.
Operate Interval	The interval between two verifications. The default value is 2 seconds, the range is 0 to 254 seconds.
Verification Mode	The default setting is "Card or Fingerprint". The Wiegand reader supports "Only Card", "Only Password", "Card or Password", "Card and Password", "Card or Fingerprint". The RS485 reader supports "Card or Fingerprint". Make sure the reader has a keyboard when the verification mode is "Card and Password".
The above settings are copied to	Apply the above settings to all readers within the current user's level. Click OK to save and exit.

8.3.4 Floor Floor Setting

The setting of floor parameters affects the logical judgment of Elevator control verification.

8.3.4.1 Edit

Operating Steps:

Step 1: In the **Elevator Control** module, select "**Elevator Control device > Floor**".

Step 2: In the floor management interface, click the **Edit** button in the floor selection operation bar to pop up the floor parameter setting box.

Step 3: In the floor parameter setting interface, fill in the corresponding parameters according to the addition requirements, as shown in Figure 8-5. Please refer to Table 8-3 for parameter filling instructions.

Figure 8-8 Floor Parameter Setting

Parameter	How to set
Owned Device	Displays the basic information of this floor, and reset is not supported.
Floor Number	The system automatically numbers the device according to the number of relays.
Floor Name	It defaults to "device Name-Floor Number", which can be repaired as needed, and can be filled in with a maximum of 30 arbitrary characters.
Effective Time Period of Floor	When editing a floor, the effective time period of the floor is required. Only after the effective time period of the floor is set can the close floor button be continuously released.
Time Period for Continuously Releasing Keys	It must be valid within the effective period of the floor. It is recommended to set the continuous release period of the floor. The setting is included in the effective period of the floor.
Key Holding Time	Used to control swiping cards or pressing fingerprints, within the range of time, you can press the floor buttons of elevators. The default is 5 seconds, and the range is 0-254.
Copy The Above Settings To	Set which floors the above floor parameters also apply to. The options are: all floors of current device and floors of all device.

Table 8-3 Instructions for Setting Floor Parameters

Step 4: Click **OK** to complete the operation of adding Elevator-controlled floors.

8.3.4.2 Remotely Release the Button

It determines whether the corresponding key to the selected floor can be pressed. You can customize the key release duration (15s by default) or select Enable Intraday Passage Mode Time Zone. You can also directly set the current status of the floor to continuously release. In this case, the floor is not subject to restrictions of any periods, including Floor Active Time Zone, Floor Passage Mode Time Zone, and Button Open Duration. That is, the floor will be continuously released in 24 hours every day.

8.3.4.3 Remotely Lock the Button:

This normal event is triggered if a user remotely locks a button successfully.

8.3.4.4 Remote Normal Opening

The person having open door permission punch effective card at the opened door to trigger this normal event.

8.3.4.5 Enable Intraday Passage Mode Timezone

If the intraday passage mode time zone is disabled, punch effective card for five times (must be the same user) or select Enable Intraday Passage Mode Time Zone in remote opening operation, and this normal event is triggered.

8.3.4.6 Disable Intraday Passage Mode Timezone

In door normal open state, punch effective card for five times (must be the same user) or select **Disable Intraday Passage Mode Time Zone** in remote closing operation, and this normal event is triggered.

8.3.5 Auxiliary Input

It is mainly used to connect to devices, such as the infrared sensor or smog sensor.

8.3.5.1 Edit

Operating Steps:

Step 1: Click **Elevator Device** > **Auxiliary Input** on the Action Menu, enter into the following page.

Step 2: Click **Edit** to modify the parameters

Figure 8-9 Auxiliary Input Add Interface

Parameter	How to set
Device Name	You can customize the name according to your preference.
Number	Displays the Number.
Name	It displays the default name of "Auxiliary Input"
Printed Name	The printing name in the hardware, for example IN9.
Remark	Displays the Comment.

8.3.6 Event Type

Display the event types of the elevator devices.

Operating Steps

Step 1: Click **Elevator Device > Event Type**, the following page is displayed:

Refresh				
Event Name	Event No.	Event Level	Device Name	Serial No.
Normal Punch Open	0	Normal	192.168.90.235	0013130700074
Punch during Passage Mode Time Zone	1	Normal	192.168.90.235	0013130700074
Open during Passage Mode Time Zone	5	Normal	192.168.90.235	0013130700074
Remote Release	8	Normal	192.168.90.235	0013130700074
Remote Locking	9	Normal	192.168.90.235	0013130700074
Disable Intraday Passage Mode Time Zone	10	Normal	192.168.90.235	0013130700074
Enable Intraday Passage Mode Time Zone	11	Normal	192.168.90.235	0013130700074
Normal Fingerprint Open	14	Normal	192.168.90.235	0013130700074
Press Fingerprint during Passage Mode Time Zone	16	Normal	192.168.90.235	0013130700074
Operate Interval too Short	20	Exception	192.168.90.235	0013130700074
Button Inactive Time Zone(Punch Card)	21	Exception	192.168.90.235	0013130700074
Illegal Time Zone	22	Exception	192.168.90.235	0013130700074
Access Denied	23	Exception	192.168.90.235	0013130700074
Disabled Card	27	Exception	192.168.90.235	0013130700074
Card Expired	29	Exception	192.168.90.235	0013130700074
Password Error	30	Exception	192.168.90.235	0013130700074
Press Fingerprint Interval too Short	31	Exception	192.168.90.235	0013130700074

Figure 8-10 Event Type Interface

8.3.7 Device Monitoring

8.3.7.1 Export

By default, it monitors all devices within the current user’s level, click **Elevator Device > Device Monitoring**, and lists the operation information of devices: Device Name, Serial No., Area, Operation Status, current status, commands List, and Related Operation.

Device Name	Serial Number	Area	Operation Status	Current Status	Commands List	Recently The Abnormal State	Operations
192.168.214.66	0013130700074	Area Nameaa	Get real-time event	Normal	0	None	Clear Command View Command

Figure 8-11 Device monitoring Interface

8.3.8 Real Time Monitoring

8.3.8.1 Operating Steps

Click **Elevator Device > Real-Time Monitoring**, real-time monitor the status and real-time events of elevator controllers in the system, including normal events and abnormal events (including alarm events).

Time	Area Name	Device Name	Event Point	Event Description	Card Number	Person	Reader Name	Verification Mode
2017-02-10 16:11:12	Area Name: 192.168.214.66(00131		192.168.214.66-2	Remote Release				Other
2017-02-10 16:11:12	Area Name: 192.168.214.66(00131		192.168.214.66-1	Remote Release				Other
2017-02-10 16:11:01	Area Name: 192.168.214.66(00131		192.168.214.66-Read	Disabled Card	2338484	2829(xinxiao yang)	192.168.214.66-Read	Card or Fingerprint
2017-02-10 16:10:47	Area Name: 192.168.214.66(00131		192.168.214.66-Read	Disabled Card	2338484	2829(xinxiao yang)	192.168.214.66-Read	Card or Fingerprint
2017-02-10 16:10:44	Area Name: 192.168.214.66(00131		192.168.214.66-Read	Disabled Card	2338484	2829(xinxiao yang)	192.168.214.66-Read	Card or Fingerprint

Total Received:5 ●Normal:2 ●Exception:3 ●Alarm:0 Clear Rows Data Event Description Play Audio [v] Show Photos [v]

Figure 8-12 Real Monitoring

8.3.8.2 Remotely Release the Button

Click **Remotely Release Button**:

Security Verification ✕

User Password*

OK
Cancel

Figure 8-13 Security Verification

Input the user password (the system logging password), click **Next Step**:

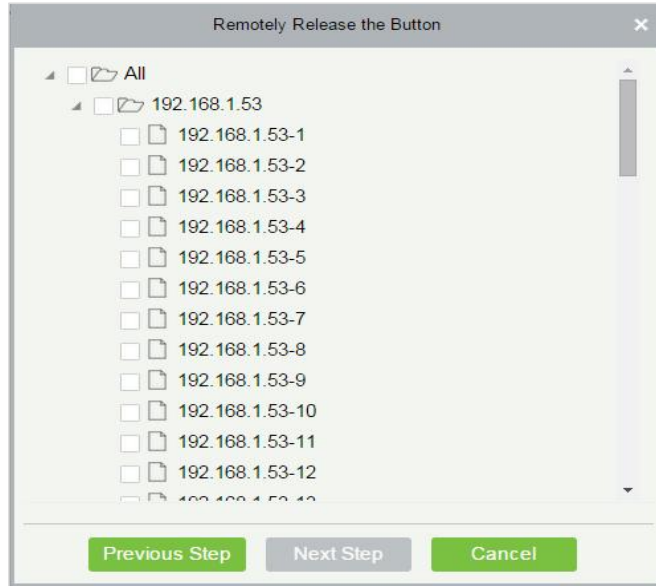

Figure 8-14 Remotely Release Button

Select the floor, and click **Next Step**:

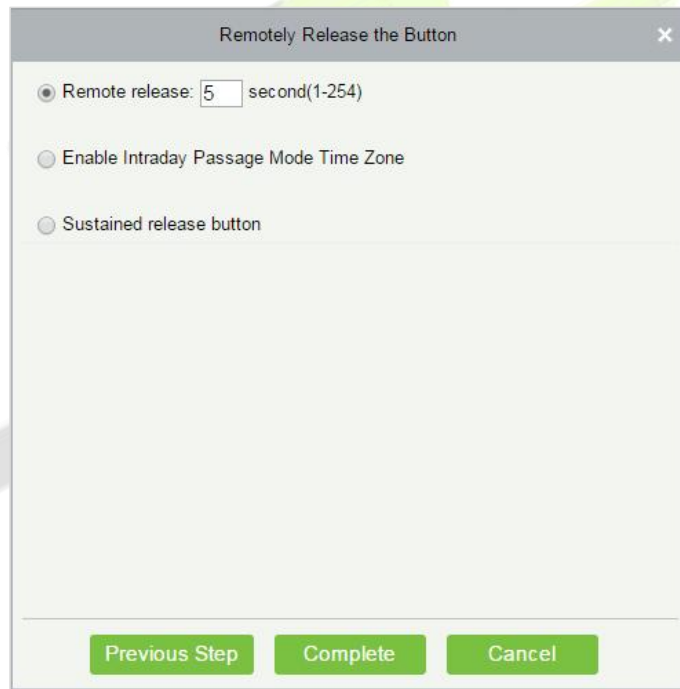

Figure 8-15 Remotely Release Button

8.3.8.3 Remotely Lock the Button

Same as “Remotely Release the button”.

Remote Release:

It determines whether the corresponding key to the selected floor can be pressed. You can customize the key release duration (15s by default) or select Enable Intraday Passage Mode Time Zone. You can also directly set the current status of the floor to continuously release. In this case, the floor is not subject to restrictions of any periods, including Floor Active Time Zone, Floor Passage Mode Time Zone, and Button Open Duration. That is, the floor will be continuously released in 24 hours every day.

Enable Intraday Passage Mode Time Zone:

To close a floor, you must first set Disable Intraday Passage Mode Time Zone to prevent the case that the floor is opened because other continuous open periods take effect. Then, you need to set to close the Remote Lock Button.

Sustained Release Button:

The floor that is set to the continuously release state is not subject to restrictions of any periods, that is, the floor will be continuously released in 24 hours every day. To close the floor, you must select Disable Intraday Passage Mode Time Zone.

Note: If a failure message is always returned for the remote release key, check whether there are too many currently disconnected devices on the device list. If yes, check the network connection.

Select the options, click **Complete** to finish enabling the button.

8.4 Elevator Control Rules

8.4.1 Time Period Setting Time Zones

In Elevator control, time period is a very important basic concept, which is used to set the use time of floors and specify that Elevator control can be used in effective time period.

This paper introduces the configuration Steps of manually adding time periods in.

8.4.1.1 New

Operating Steps:

Step 1: In the **Elevator Control** module, select "**Elevator Control Rules > Time Period**".

Step 2: Click **Add** to pop up the interface of adding time period.

Step 3: Add the interface in the time period and set the corresponding content according to the new requirements, as shown in Figure 8-6. Please refer to Table 8-4 for parameter setting instructions.

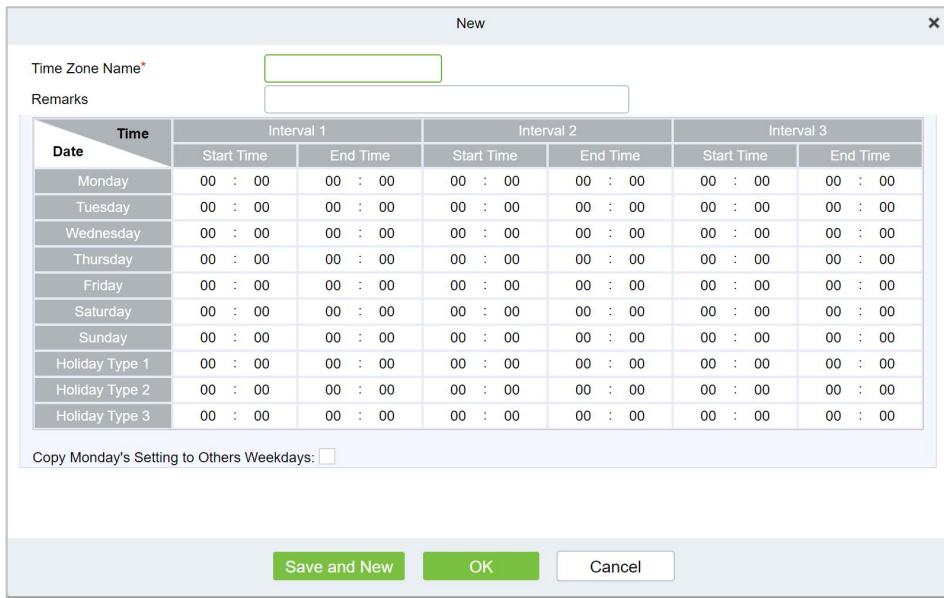

Figure 8-16 New Time Period

Parameter	How to set
Time Period Name	Custom setting time period name for easy memory.
Remarks	Custom Setting Notes Description.
Time Interval	Set the start and end time in each time interval. Time period includes one week and three holiday type time intervals.
Copy Monday time to other working days	You can quickly copy Monday settings to other workdays.

Table 8-4 Description of New Parameter Settings in Time Interval

Step 4: Click **OK** to complete the addition of this time period.

8.4.1.2 Delete

Step 1: On the **Time Zone** interface, select the required time zone from the list.

Step 2: Click **Delete** or click on the  icon to delete the selected time zone.

Step 3: Click **Delete**, to ensure and delete the selected time zone from the list.

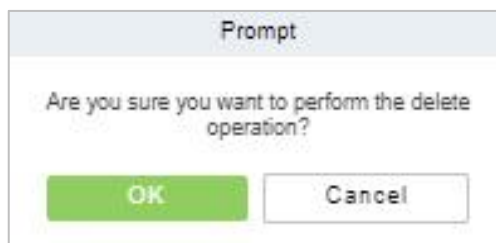

Figure 8-17 Delete Time Period

8.4.2 Holiday Setting

The Elevator control time on holidays may be different from the usual Elevator control time. For simple operation, the system supports setting the Elevator control time separately on holidays.

This paper introduces the configuration Steps of manually adding holidays in.

8.4.2.1 New

Operating Steps:

Step 1: In the **Elevator Control** module, select "Elevator Control Rules > Holidays".

Step 2: Click **New** to pop up the holiday adding interface.

Step 3: In the holiday new interface, set the corresponding content according to the new requirements, as shown in Figure 8-7; Please refer to Table 8-5 for parameter setting instructions.

Figure 8-18 New Holidays

Parameter	How to set
Holiday Name	Customize the holiday name for easy memory.
Holiday Type	Customize the holiday type: Holiday Type 1, Holiday Type 2, Holiday Type 3. The holiday type is set and selected in the "Time Period" addition.
Start Time/End Time	Set the time range for this holiday.
Annualized Cycle	Set whether this holiday cycle year by year: Yes, no. For example, if New Year's Day is January 1 of each year, it can be set to "Yes"; Mother's Day is the second Sunday in May every year. If the date is uncertain, it will be set to "No".
Remarks	Custom settings description.

Table 8-5 Parameter Setting Description for Holidays

Step 4: Click **OK** to complete the operation of Elevator-controlled holidays.

8.4.2.2 Delete

Step 1: On the **Holidays** interface, select the required holidays from the list.

Step 2: Click **Delete** or click on the  icon to delete the selected holidays.

Step 3: Click **Delete**, to ensure and delete the selected holidays from the list.

8.4.3 Elevator Levels

Elevator levels indicate that one or several selected doors can be opened by verification of a combination of multi person within certain time zone. The combination of multi-person set in Personnel Access Level option.

8.4.3.1 New

Operating Steps:

Step 1: Click **Elevator > Access Levels > New** to enter the Add Levels editing interface.

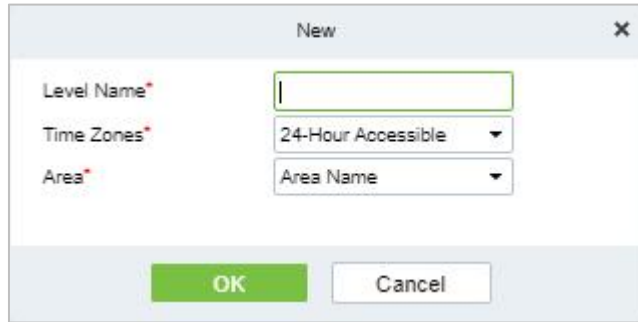

Figure 8-19 Elevator Level Add Interface

Step 2: Set each parameter: Level Name (unrepeatable), Time Zone and Area.

Step 3: Click **OK**, the system prompts "Add floors to the current elevator control level immediately", click **OK** to add floors, click **Cancel** to return the elevator levels list. The added level is displayed in the list.



Figure 8-20 Elevator Level Cancel Interface

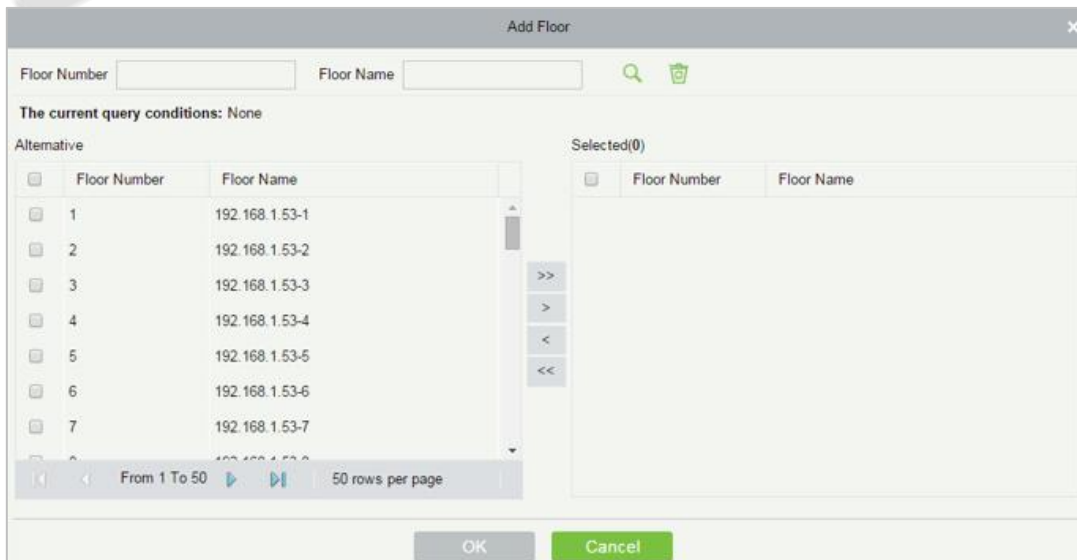

Figure 8-21 Elevator Level Add Interface

Note: Different floors of different elevator controllers can be selected and added to an elevator level.

8.4.3.2 Delete

Step 1: On the **Elevator Level** interface, select the required level from the list.

Step 2: Click **Delete** or click on the  icon to delete the selected level floors.

Step 3: Click **Delete**, to ensure and delete the selected level from the list.

8.4.4 Set Access by Levels

Operating Steps:

Step 1: Click Elevator > Set by Levels to enter the edit interface, Click an Elevator level in left list, personnel having right of opening door in this access level will display on right list.

Step 2: In the left list, click **Add Personnel** under Operations to pop-up the Add Personnel box; select personnel (multiple) and click  to move it to the right selected list, then click **OK** to save and complete.

Step 3: Click the level to view the personnel in the right list. Select personnel and click **Delete Personnel** above the right list, then Click **OK** to delete.

8.4.4.1 Delete Personnel

Step 1: On the **Access Level** interface, select the required Personnel ID from the list.

Step 2: Click **Delete** or click on the  icon to delete the selected Personnel ID.

Step 3: Click **Delete**, to ensure and delete the selected Personnel ID from the list.

8.4.5 Set Access by Person

Add selected personnel to selected elevator levels or delete selected personnel from the elevator levels.

Operating Steps:

Step 1: Click **Elevator > Elevator Levels > Set by Person**, click employee to view the levels in the right list.

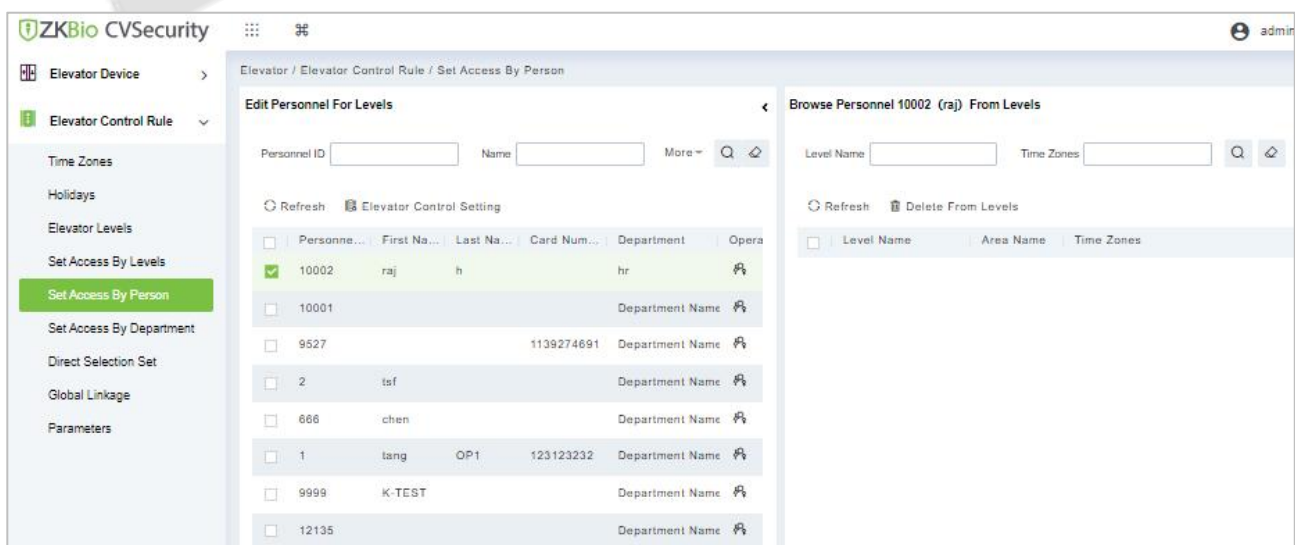

Figure 8-22 Set Access by Person Interface

8.4.5.1 Delete from Levels

Step 1: Select Level (multiple) in the right list and click **Delete from levels** above the list, then click **OK** to delete the selected levels.

8.4.5.2 Elevator Control Setting

Setting Levels for Selected Personnel:

Step 1: Select a person in the list on the left and click **Elevator Control Setting**. The following page is displayed:

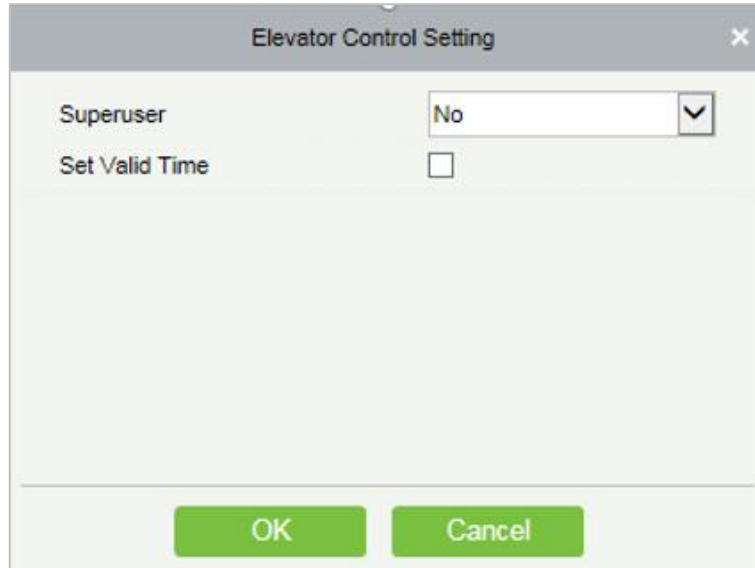

Figure 8-23 Elevator Control Setting

Step 2: In the left list, click **Add Personnel** under Operations to pop-up the Add Personnel box; select personnel (multiple) and click > to move it to the right selected list, then click **OK** to save and complete.

8.4.6 Set Access by Department

Operating Steps:

Step 1: Add selected department to selected elevator levels or delete selected department from the elevator levels. The access of the staff in the department will be changed.

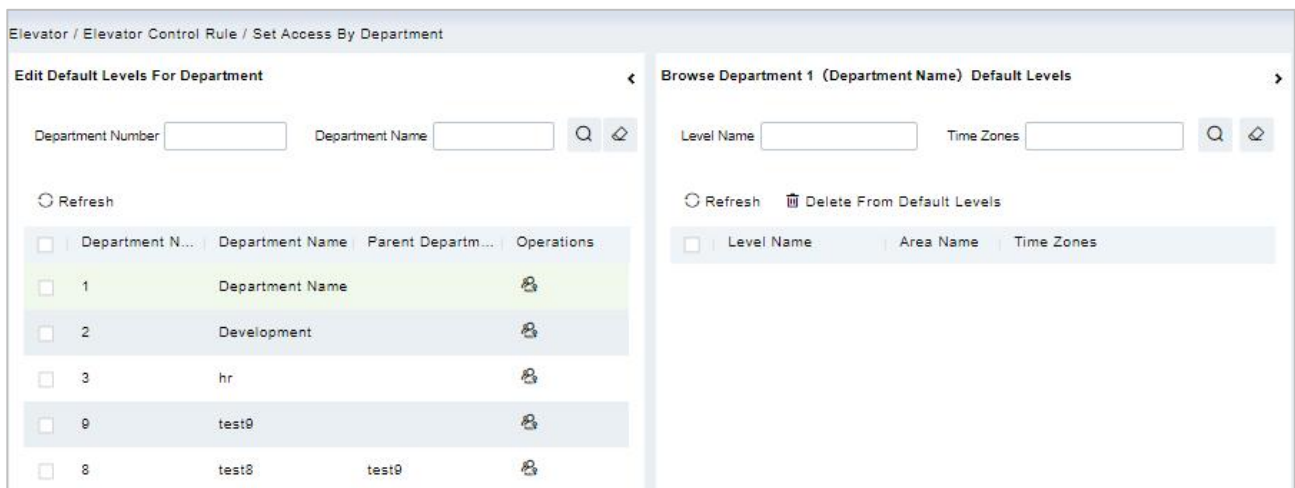

Figure 8-24 Set Access by Department Interface

8.4.6.1 Delete from Default Levels

Select Level (multiple) in the right list and click **Delete from levels** above the list, then click **OK** to delete the selected levels.

8.4.7 Direct Selection Set

8.4.8 Linkage Setting Global Linkage

The use method and scene of linkage are very flexible. After a specific event is triggered at an input point in the Elevator control system, a linkage action will be generated at the designated output point to control the events such as door opening, alarm and abnormality in the system.

8.4.8.1 New

Operating Steps:

Step 1: In the **Elevator Control** module, select "Elevator Control Rules > Global Linkage".

Step 2: In the linkage setting interface, select and click the **Add** button, as shown in Figure 8-9, and refer to Table 8-6 for linkage parameter setting.

Figure 8-25 New Linkage Configuration Interface

Parameter	How to set
Linkage Name	Custom setting linkage name for easy reference
LinkageTrigger Condition	Select the condition that the linkage operation triggers, that is, the type of event generated by the selected device
Input Point	Select the input point to set the device input

Output Point	Select the output point to set the output of the device
Linkage Action Setting	Select and set linkage action, including device operation at output point, video linkage and mail

Table 8-6 New Linkage Parameter Setting Description

Step 5: Click **OK** to complete the linkage configuration.

8.4.8.2 Delete

Step 1: On the **Elevator** interface, select the required linkage from the list.

Step 2: Click **Delete** or click on the  icon to delete the selected linkage.

Step 3: Click **Delete**, to ensure and delete the selected linkage from the list.

8.4.8.3 Enable/Disable

Select device, click **Disable/Enable** to stop/start using the device. When communication between the device and the system is interrupted or device fails, the device may automatically appear in disabled status. After adjusting local network or device, click **Enable** to reconnect the device and restore device communication.

8.4.8.4 Delete Personnel

Step 1: On the **Elevator** interface, select the required Personnel ID of the Global Linkage from the list.

Step 2: Click **Delete** or click on the  icon to delete the selected Personnel ID.

Step 3: Click **Delete**, to ensure and delete the selected Personnel ID from the list.

8.4.9 Parameters

Operating Steps:

Step 1: Click **Elevator > Elevator > Parameters:**

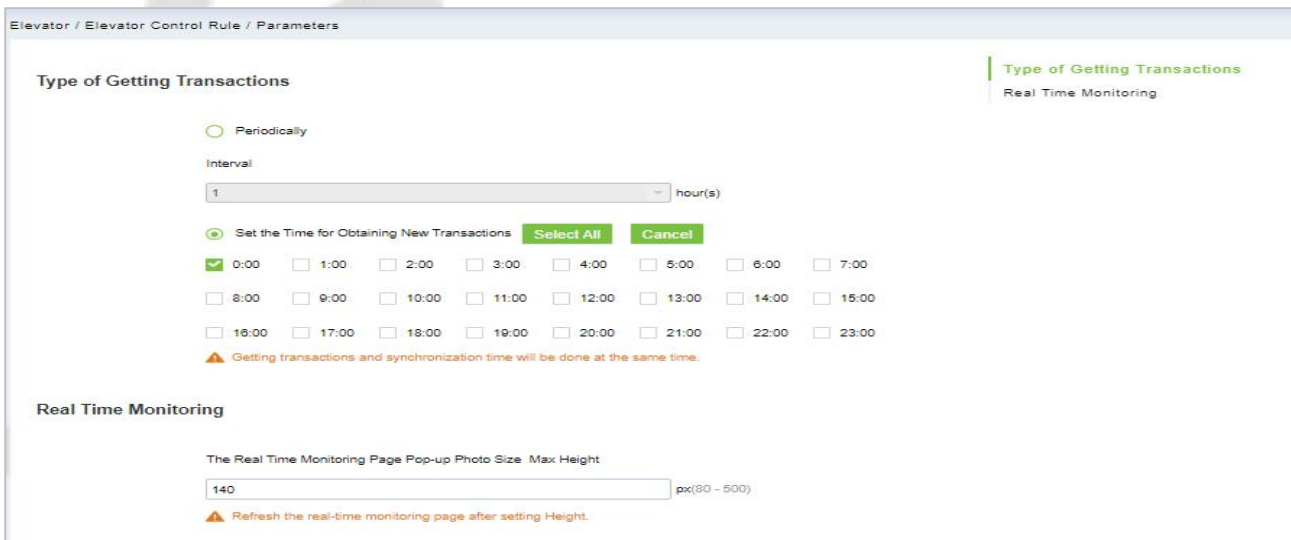

Figure 8-26 Parameters Interface

Parameter	How to set
Type of Getting Transaction	Start from the setting and efficient time, the system attempts to download new transactions every time interval.

Real Time Monitoring	When an access control event occurs, the personnel photo will pop up, set the size of the pop-up photos, the range is 80-500px.
----------------------	---

Table 8-7 Parameter Setting Description

8.5 Elevator Control Reports

8.5.1 All Transaction

Because the data size of elevator access control event records is large, you can view elevator access control events as specified condition when querying. By default, the system displays the latest three months transactions.

8.5.1.1 Clear All Data

Operating Steps:

Step 1: Click **Reports > All Transactions** to view all transactions:

Time	Device	Event Point	Event Description	Media File	Personnel ID	First Name	Last Name	Card Number	Department	Reader Name	Verification Mode
2015-05-22 17:01:00	192.168.60.53	192.168.60.53-1	Normal Punch Open		11	jolly	wei	3406918	General	192.168.60.53-Ri	Card or Passw
2015-05-22 17:01:00	192.168.60.53	192.168.60.53-1	Trigger global linkage		11	jolly	wei	3406918	General	192.168.60.53-Ri	Card or Passw
2015-05-22 17:01:00	192.168.60.53	192.168.60.53-2	Normal Punch Open		11	jolly	wei	3406918	General	192.168.60.53-Ri	Card or Passw
2015-05-22 17:01:00	192.168.60.53	192.168.60.53-2	Trigger global linkage		11	jolly	wei	3406918	General	192.168.60.53-Ri	Card or Passw
2015-05-22 17:00:49	192.168.60.53	192.168.60.53-1	Normal Punch Open		11	jolly	wei	3406918	General	192.168.60.53-Ri	Card or Passw
2015-05-22 17:00:49	192.168.60.53	192.168.60.53-1	Trigger global linkage		11	jolly	wei	3406918	General	192.168.60.53-Ri	Card or Passw
2015-05-22 17:00:49	192.168.60.53	192.168.60.53-2	Normal Punch Open		11	jolly	wei	3406918	General	192.168.60.53-Ri	Card or Passw
2015-05-22 17:00:49	192.168.60.53	192.168.60.53-2	Trigger global linkage		11	jolly	wei	3406918	General	192.168.60.53-Ri	Card or Passw
2015-05-22 16:58:26	192.168.60.53	192.168.60.53-2	Normal Punch Open		11	jolly	wei	3406918	General	192.168.60.53-Ri	Card or Passw

Figure 8-27 All Transaction Interface

Step 2: Click **Clear All Data** to pop up prompt and click **OK** to clear all transactions.

8.5.1.2 Export

Step 1: You can export all transactions in Excel, PDF, CSV format.

Time	Device	Event Point	Event Description	Personnel ID	First Name	Last Name	Card Number	Department	Reader Name	Verification Mode	Area	Remark
2017-12-15 10:36:43	192.168.218.65	192.168.218.65-8	Normal Punch Open	3	Leo	Hou	13260079	General	192.168.218.65-Reader	Card or Fingerprint	Area Name	
2017-12-15 10:36:43	192.168.218.65	192.168.218.65-5	Normal Punch Open	3	Leo	Hou	13260079	General	192.168.218.65-Reader	Card or Fingerprint	Area Name	
2017-12-15 10:36:43	192.168.218.65	192.168.218.65-9	Normal Punch Open	3	Leo	Hou	13260079	General	192.168.218.65-Reader	Card or Fingerprint	Area Name	
2017-12-15 10:36:39	192.168.218.65	192.168.218.65-1	Normal Punch Open	1	Jerry	Wang	9505930	General	192.168.218.65-Reader	Card or Fingerprint	Area Name	
2017-12-15 10:36:39	192.168.218.65	192.168.218.65-4	Normal Punch Open	1	Jerry	Wang	9505930	General	192.168.218.65-Reader	Card or Fingerprint	Area Name	
2017-12-15 10:36:39	192.168.218.65	192.168.218.65-3	Normal Punch Open	1	Jerry	Wang	9505930	General	192.168.218.65-Reader	Card or Fingerprint	Area Name	
2017-12-15 10:36:39	192.168.218.65	192.168.218.65-2	Normal Punch Open	1	Jerry	Wang	9505930	General	192.168.218.65-Reader	Card or Fingerprint	Area Name	
2017-12-15 10:36:36	192.168.218.65	192.168.218.65-8	Normal Punch Open	2	Lucky	Tan	13271770	General	192.168.218.65-Reader	Card or Fingerprint	Area Name	
2017-12-15 10:36:36	192.168.218.65	192.168.218.65-10	Normal Punch Open	2	Lucky	Tan	13271770	General	192.168.218.65-Reader	Card or Fingerprint	Area Name	
2017-12-15 10:36:36	192.168.218.65	192.168.218.65-9	Normal Punch Open	2	Lucky	Tan	13271770	General	192.168.218.65-Reader	Card or Fingerprint	Area Name	
2017-12-15 10:36:36	192.168.218.65	192.168.218.65-7	Normal Punch Open	2	Lucky	Tan	13271770	General	192.168.218.65-Reader	Card or Fingerprint	Area Name	
2017-12-15 10:36:31	192.168.218.65	192.168.218.65-6	Normal Punch Open	2940	Sherry	Yang	4481253	General	192.168.218.65-Reader	Card or Fingerprint	Area Name	
2017-12-15 10:36:31	192.168.218.65	192.168.218.65-8	Normal Punch Open	2940	Sherry	Yang	4481253	General	192.168.218.65-Reader	Card or Fingerprint	Area Name	
2017-12-15 10:36:31	192.168.218.65	192.168.218.65-7	Normal Punch Open	2940	Sherry	Yang	4481253	General	192.168.218.65-Reader	Card or Fingerprint	Area Name	
2017-12-15 10:36:31	192.168.218.65	192.168.218.65-5	Normal Punch Open	2940	Sherry	Yang	4481253	General	192.168.218.65-Reader	Card or Fingerprint	Area Name	
2017-12-15 10:36:31	192.168.218.65	192.168.218.65-5	Normal Punch Open	2940	Sherry	Yang	4481253	General	192.168.218.65-Reader	Card or Fingerprint	Area Name	
2017-12-15 10:36:31	192.168.218.65	192.168.218.65-8	Normal Punch Open	2940	Sherry	Yang	4481253	General	192.168.218.65-Reader	Card or Fingerprint	Area Name	
2017-12-15 10:36:31	192.168.218.65	192.168.218.65-6	Normal Punch Open	2940	Sherry	Yang	4481253	General	192.168.218.65-Reader	Card or Fingerprint	Area Name	

Figure 8-28 All Transaction Export Interface

8.5.2 All Exception Events

8.5.2.1 Clear All Data

Operating Steps:

Step 1: Click **Reports > All Exception Events** to view exception events in specified condition. The options are same as those of **All Transactions**.

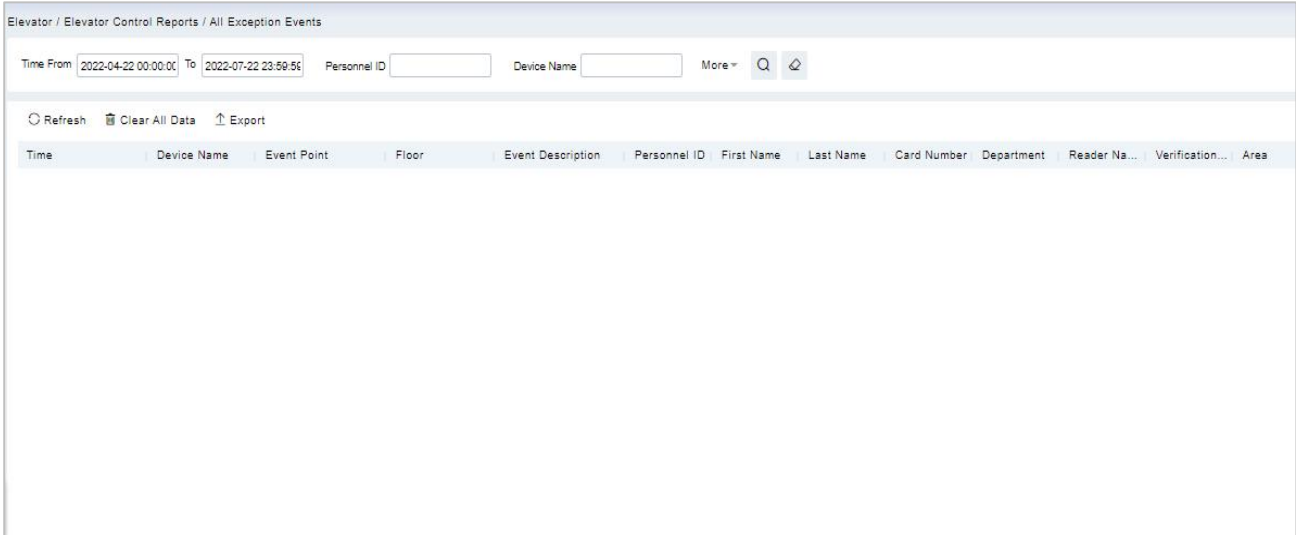

Figure 8-29 All Exception Events Interface

Step 2: Click **Clear All Data** to pop up prompt, click **OK** to clear all exception events.

8.5.2.2 Export

Step 1: You can export all exception events in Excel, PDF, CSV format.

Time	Area	Device	Event Point	Event Description	Card Number	Personnel ID	First Name	Last Name	Department	Reader Name	Verification Mode	Remark
2017-12-15 10:29:11	Area Name	192.168.214.65	192.168.214.65-Reader	Disabled Card	9005930	1	Jerry	Wang	General	192.168.214.65-Reader	Card or Fingerprint	
2017-12-15 10:29:14	Area Name	192.168.214.65	192.168.214.65-Reader	Disabled Card	4481253	2943	Sherry	Yang	General	192.168.214.65-Reader	Card or Fingerprint	
2017-12-15 10:29:09	Area Name	192.168.214.65	192.168.214.65-Reader	Disabled Card	13260079	3	Leo	Hou	General	192.168.214.65-Reader	Card or Fingerprint	
2017-12-15 10:29:09	Area Name	192.168.214.65	192.168.214.65-Reader	Operate Interval too Short	13260079	3	Leo	Hou	General	192.168.214.65-Reader	Card or Fingerprint	

Figure 8-30 All Exception Events Export Interface

8.5.3 Access Rights by Floor

Operating Steps:

Step 1: Click **Reports > Access Rights by Floor**, the data list in the left side shows all floors in the system, select a floor, the personnel having access levels to the floor will display on the right data list.



Figure 8-31 Access Right by Floor Interface

8.5.3.1 Export

Step 1: You can export all the personnel having access levels to the floor data in Excel, PDF, CSV format

192.168.218.65-1(1) Opening Personnel			
Personnel ID	First Name	Last Name	Department
2940	Sherry	Yang	Hotel
1	Jerry	Wang	General
2	Lucky	Tan	Development Department
3	Leo	Hou	Financial Department
5	Necol	Ye	Marketing Department
6	Amber	Lin	Financial Department
8	Glori	Liu	Marketing Department
9	Lilian	Mei	Development Department

Figure 8-32 Access Right By Floor AExport Interface

8.5.4 Access Rights by Personnel

Operating Steps:

Step 1: Click **Reports > Access Rights by Personnel**, the data list in the left side shows all doors in the system, select personnel, the personnel having access levels to the door will display on the right data list.

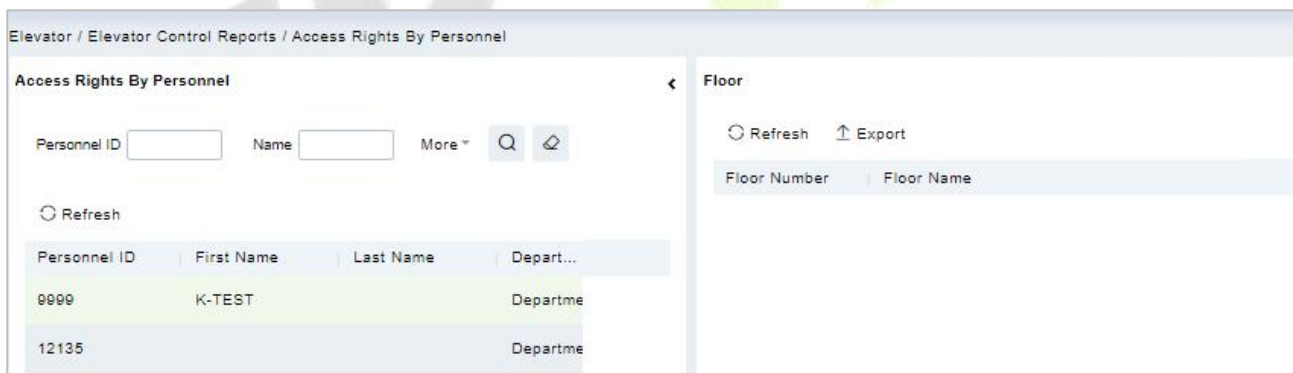

Figure 8-33 Access Right by Personnel Interface

8.5.4.1 Export

Step 1: You can export all the floor information in Excel, PDF, CSV format.

2940(Sherry) Having Level to Access	
Floor Number	Floor Name
1	192.168.218.65-1
2	192.168.218.65-2
3	192.168.218.65-3
4	192.168.218.65-4
5	192.168.218.65-5
6	192.168.218.65-6
7	192.168.218.65-7
8	192.168.218.65-8
9	192.168.218.65-9
10	192.168.218.65-10

Figure 8-34 Access Right by Personnel Export Interface

8.5.5 First In and Last Out

Click **Elevator Controls Reports** > **First In And Last Out** to view the First and the Last time interval.

8.5.5.1 Clear All Data

Click **Clear All Data** to pop up prompt and click **OK** to clear all transactions.

8.5.5.2 Export

You can export all transactions in Excel, PDF, CSV format.



9 Parking Management

9.1 Operation Scenario

In modern parking lot management, vehicle management is an important aspect, especially for special parking lots, parks and communities, it is required to strictly manage all kinds of vehicles in real time, strictly monitor their entry and exit time, and register and identify all kinds of vehicles (including internal vehicles and external vehicles). In a large-scale field, there are many vehicles coming in and out. For example, every vehicle must be judged manually, which is time-consuming and not conducive to management and inquiry, and the security work is difficult and inefficient. In order to improve this management mode, which is not commensurate with modern parking lots, residential areas, etc., It is necessary to realize the automatization and intelligence of vehicle management as soon as possible, and manage it in the form of computer network, so as to monitor and manage all the vehicles at the entrance and exit effectively and accurately. It is required that the system provide corresponding application software to realize the high efficiency and intelligence of parking lot management.

9.2 Operation Flow

This paper introduces the configuration process of parking management business.

The parking management business configuration process is shown in Figure 9-1.

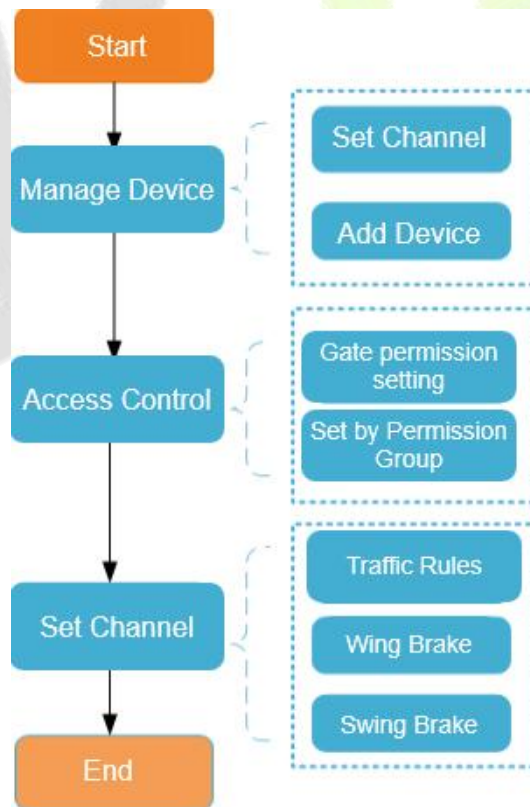

Figure 9-1 Parking Configuration Flow

9.3 Basic Parking Setting

9.3.1 Parking Settings

This paper introduces the public parameters of the parking lot under.

Operating Steps:

Step 1: In the **Parking module**", select "**Parking Basic Management > Parking Settings**".

Step 2: In the Parking setting interface, as shown in Figure 9-1, fill in relevant parameters. Please refer to Table 9-2 for parameters.

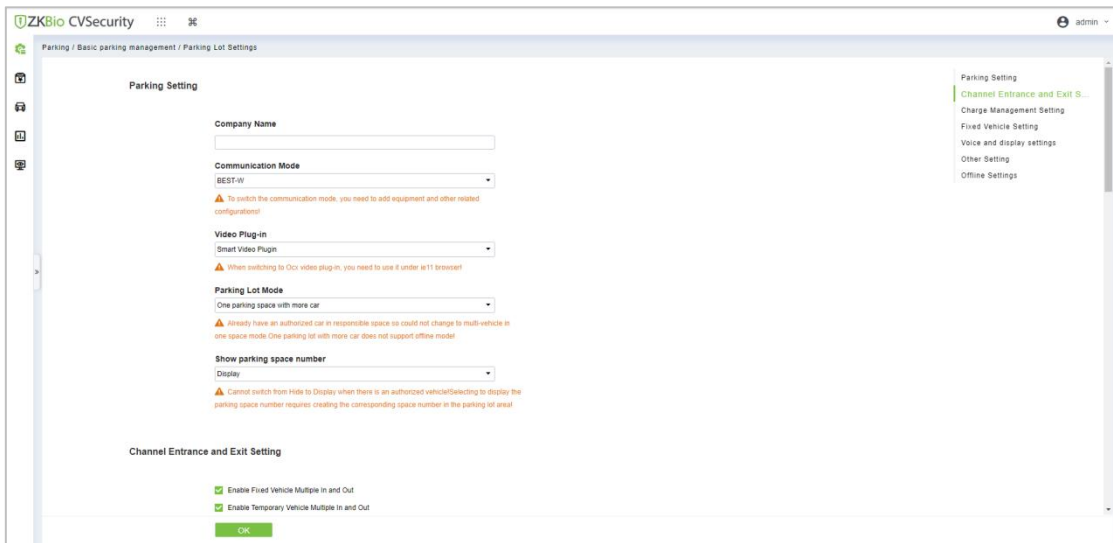

Figure 9-1 Parking Parameter Setting Interface

Parameter	Specific Parameters	Parameter Description
Parking Setting	Company Name	You can customize the Parking company name, which can be displayed in the billing receipt.
	Parking Mode	<ul style="list-style-type: none"> One car per person: means that only one fixed car can be authorized in one parking space at present. Multiple cars per person refers to a parking space that allows multiple fixed cars to be authorized.
	Display Parking Space Number	You can choose whether to display the parking space number or not, and you can specify a certain parking space number.
Channel Entrance and Exit Setting	Enable the. fixed or temporary vehicles are multiple In and out.	Allow the fixed or Temporary vehicles to the parking area and vehicle are multiple in and out.
	Matching Precision of Entrance and Exit	Vehicles are allowed by exact match and 5 or 6digits registration numbers to the entrance and exit area of the parking.
	Special license plate contains characters	Enter the special license plates contains characters wherever required.
	Duplicate license plate waiting time	In Duplicate license plate waiting time Mention the timings of single channel mode and normal mode

Parameter	Specific Parameters	Parameter Description
Charge Management Settings	Enable the fixed car charging standard	If the fixed car charging standard has been set in advance, check this setting, and when the fixed car is authorized and postponed, it will be implemented according to this charging standard; If it is not checked, you can only manually enter the extension time and amount.
	Print the charge receipt	If the receipt printer is set and connected, the corresponding receipt will be printed when the charge is successful.
	Enable consumption discounts	Set the "Discount Strategy" in advance and then check the Enable Consumption Discount System, and the consumption discount will be carried out.
	Unmatched processing mode	There are two existing ways to deal with mismatches: "free release" and "opening the gate after charging fees"; Manual release is to open the gate directly, and when the gate is opened after charging, a charge confirmation box will pop up during manual release (only for temporary vehicles).
	Synchronize data to the cloud	After opening, offline parking data will be uploaded to the cloud platform synchronously.
	Enable online payment	Enable the payment method under the scenario of Alipay and WeChat payment.
Fixed Vehicle Setting	Statistic parking space of fixed car	<ul style="list-style-type: none"> If it is checked, the number of cars will not be deducted after authorization, and the number of cars will be counted in real time when vehicles enter and leave the field. If it is not checked, the number of fixed cars will be deducted after authorization.
	Enable fixed vehicles to switch to temporary vehicles	<ul style="list-style-type: none"> If this option is checked, the fixed car will be automatically converted into a temporary car after it expires, and the charge will be made according to the temporary charging method. If it is not checked, this option will require manual release for the fixed car to come out when it expires.
	Warning days for fixed vehicles	If the warning days are set to 5 days, it is necessary to prompt the vehicles to postpone the fixed vehicles when entering and leaving the field within 5 days.
Voice And Display Settings	Enable external display	Checking this parameter will display the relevant parking data on the external display.
	The entrance shows the remaining parking spaces	Display the remaining parking spaces at the entrance of the parking lot.
	Statistics of car Parking area parking spaces in car Parking area	The statistics of the number of cars in the corresponding booth in the big Parking area include the number of cars in the small Parking area.
	Vehicle entry and exit broadcast license plate	If this parameter is checked, the license plate will be broadcast when the vehicle enters and exits.
	Display color	Set the display color of parking machine.

Parameter	Specific Parameters	Parameter Description
Other Settings	Maximum vehicle stay time	Set the maximum stay time of on-site vehicles. If the on-site vehicles have not left after this time, the records of on-site vehicles will be displayed in the "On-site Stay Timeout Vehicles" report.
	Save days of snapshot photos	Set snapshot photos saved more than the set number of days photos will be automatically deleted, if you do not want to delete snapshot photos will change the parameter set to 0 days.
	Snapshot Save Path	You can customize the path where photos are saved.

Table 9-2 Description of Parking Parameters

Step 3: After setting the parameters, Click **OK**.

9.3.2 Device

For communication between the system and device, data uploading, configuration downloading, device and system parameters shall be set. Users can edit access controllers within relevant levels in the current system; users can only add or delete devices in Device Management if needed.

9.3.2.1 Edit or Delete a Device

Step 1: Click Device Name or click **Edit** to access the edit interface.

Step 2: Select device, click **Delete**, and click **OK** to delete the device

9.3.2.2 Reboot Device

It will reboot the selected device.

9.3.2.3 Synchronize Time

It will synchronize time with server's current time.

9.3.2.4 Get Device Parameters

Click Get Device Parameters Users can get device parameters which is they need from the system.

9.3.2.5 Delete Device command

Click DeleteDevice command, to delete the selected device command' data.

9.3.2.6 Get Device Version

Click Device version to get selected device version.

9.3.3 Parking Area

This paper introduces the Step configuration of and Parking area.

9.3.3.1 Add New

Operating Steps:

Step 1: In the **Parking** module, select **Parking Basic Management > Parking Area**.

Step 2: In the **Parking Area** interface, click **Add New** and fill in the relevant parameters, as shown in Figure 9-3. Please refer to Table 9-4 for parameter description.

Figure 9-3 New Interface in Parking Area

Parameter	Description
Type Of Parking Area	Set whether the current Parking area is a big Parking or a small Parking.
Name Of Parking Area	The name of the Parking area cannot be duplicated.
Parking Spaces	Set total number of parking spaces in this area.
Remarks	Text description.

Table 9-4 Parameter Description of Parking Area

Step 3: Click **OK** to complete the setting of the Parking area.

9.3.3.2 Edit

Click a parking area name or **Edit** in the operation column to go to the Edit page. Make modifications and click **OK** to save modifications.

9.3.3.3 Delete

Select one or more parking areas and click **Delete** at the upper part of the list and click **OK** to delete the selected parking areas. Click **Cancel** to cancel the operation or click **Delete** in the operation column to delete a single parking area.

9.3.3.4 Refresh

Click **Refresh** at the upper part of the list to load new parking areas.

9.3.4 Entrance And Exit Area

This paper introduces the Step configuration of parking entrance and exit area.

9.3.4.1 Add New

Operating Steps:

Step 1: In the **Parking** module, select "**Parking Basic Management > Entrance and Exit Area**".

Step2: In the interface of Entrance and Exit Area, click **Add New** and fill in relevant parameters, as shown in Figure 9-5. Please refer to Table 9-6 for parameter description.

Figure 9-5 Add Interface of Entrance and Exit Area

Parameter	Description
Parking Area	The name of Entrance and Exit Area cannot be duplicated.
Name Of Entrance and Exit Area	The Parking area to which the Entrance and Exit Area belongs.

Table 9-6 Description of Parameters of Entrance and Exit Area

Step 3: Click **OK** to complete the setting of Entrance and Exit Area.

9.3.4.2 Edit

Click an entrance and exit area name or **Edit** in the operation column to go to the Edit page. Make modifications and click **OK** to save modifications.

9.3.4.3 Delete

Select one or more entrance and exit areas and click **Delete** at the upper part of the list and click **OK** to delete the selected entrance and exit areas. Click **Cancel** to cancel the operation or click **Delete** in the operation column to delete a single entrance and exit area.

9.3.4.4 Refresh

Click **Refresh** at the upper part of the list to load new entrance and exit areas.

9.3.5 Guard Booth

This paper introduces the Step configuration of ZKBio CVSecurity Guard Booth. After the configuration is completed, you can check and monitor the Guard Booth interface and operate the gate opening.

9.3.5.1 Add New

Operating Steps:

Step 1: In the **Parking** module, select "**Parking Basic Management > Guard Booth**".

Step 2: In the **Guard Booth** interface, click **Add New** and fill in the relevant parameters, as shown in Figure 9-7. Please refer to Table 9-8 for parameter description.

Figure 9-7 Added Guard Booth Interface

Parameter	Description
Name of Guard Booth	Set the name of the booth.
Guard Booth Computer IP	When the booth mode is browser, the IP address of the booth needs to be set.
Guard Booth Mode	There are two modes of Guard Booth: <ul style="list-style-type: none"> • Browser: You need to set the IP of the booth computer • Platform: Automatically generate platform registration code
Platform Registration Code	When the booth mode is a platform, it is automatically generated for CS booth registration.
Name Of Entrance and Exit Area	Entrance and Exit Area to which the booth belongs.
Parking Area	After selecting the Entrance and Exit Area, the information of the parking lot area will be read, which is read-only.
Allow Temporary Cars Free of Charge	Set whether the temporary car is free or not, check the interface of opening the billing result of the temporary car, and there will be a "Free" button to allow the temporary car to be free.
Enable Replacement Models	Set whether the replacement vehicle is enabled or not and check the temporary vehicle charging result interface to change the temporary vehicle type of the vehicle. Different vehicle types have different charging standards, so the charging result will also change.
Enable Manual Clearance	Set whether to enable manual release. After checking Enable, you can manually control the gate to open for vehicle release.

Parameter	Description
Temporary Cars Come Out Quickly	Set whether to enable the temporary car to come out quickly. If the temporary car does not incur parking fees after checking the enable, the billing result confirmation interface will not pop up, and the gate will be opened and released directly.
Single Channel Mode	Set whether to enable the single channel mode. After checking Enable, the previous channel of the current scene application can be used for both entry and exit. However, in terms of logical settings, it is recommended to establish different logical channels to bind different IPC devices.

Table 9-8 Parameter Description of Guard Booth

9.3.5.2 Edit

Click a guard booth name or **Edit** in the operation column to go to the Edit page. Make modifications and click **OK** to save modifications.

9.3.5.3 Delete

Select one or more guard booths and click **Delete** at the upper part of the list and click **OK** to delete the selected guard booths. Click **Cancel** to cancel the operation or click **Delete** in the operation column to delete a single guard booth.

9.3.5.4 Refresh

Click **Refresh** at the upper part of the list to load new guard booths.

9.3.6 Channel

This paper introduces the configuration of relevant Steps of parking passage.

9.3.6.1 Add New

Operating Steps:

Step 1: In the Parking module, select **Parking Basic Management > Passage**.

Step 2: Click **Add New** in the channel interface and fill in the relevant parameters, as shown in Figure 9-9. Please refer to Table 9-10 for parameter description.

Figure 9-9 New Channel Interface

Parameter	Description
Channel Name	You can customize the channel name here
Name of Guard Booth	Select the corresponding booth
Import And Export Status	Select the channel properties of the entrance and exit of the corresponding booth entrance and exit area
IPC1_IP/IPC1 Corresponds to Video Port Position	The ip address of device 1, and the corresponding video port position is the monitoring position where the device is located
IPC2_IP/IPC2 Corresponds to Video Port Position	The ip address of device 2, and the corresponding video port position is the monitoring position where the device is located
Opening Mode of Fixed Car	Direct release (open the gate directly after identifying the license plate) Confirm the release (pop up the confirmation box and click the button manually to open the gate)
Temporary Vehicle Opening Mode	Pick up and release (open the gate directly after identifying the license plate) Confirm the release (pop up the confirmation box and click the button manually to open the gate)
Type of Vehicles Prohibited from Passing in Limited Mode	You can set those car types not to pass here, and you can choose multiple

Table 9-10 Description of Channel Parameters

Step 3: Click **OK** to complete the channel setting.

9.3.6.2 Edit

Click a channel name or **Edit** in the operation column to go to the Edit page. Modify and click **OK** to save modifications.

9.3.6.3 Delete

Select one or more channels and click **Delete** at the upper part of the list and click **OK** to delete the selected channels. Click **Cancel** to cancel the operation or click **Delete** in the operation column to delete a single channel.

9.3.6.4 Refresh

Click **Refresh** at the upper part of the list to load new channels.

9.3.7 Vehicle Definition

This paper introduces the configuration of related Steps of vehicle definition.

9.3.7.1 Add New

Operating Steps:

Step 1: In the Parking module, select **Parking Basic Management > Vehicle Definition**.

Step 2: Click **Add New** in the vehicle definition interface and fill in the relevant parameters, as shown in Figure 9-11. Please refer to Table 9-12 for parameter description.

Figure 9-11 New vehicle definition

Parameter	Description
Vehicle Definition	Select the corresponding. vehicle
Vehicle Type	Vehicle type of the charging standard
Status	Select the vehicle status enable or disable
Remarks	Text description

Table 9-12 Description of vehicle definition Parameters

9.3.7.2 Editing the Vehicle Type

Step 1: Click a vehicle type name or **Edit** in the operation column. The Edit page is displayed.

Figure 9-13 Edit Vehicle Type

Step 2: Set Vehicle Type, select a Status, and enter the vehicle type description in Remark.

Step 3: Click **OK** to save and exit.

9.3.7.3 Delete

Select one or more channels and click **Delete** at the upper part of the list and click **OK** to delete the selected channels. Click **Cancel** to cancel the operation or click **Delete** in the operation column to delete a vehicle definition.

9.3.7.4 Refresh

Click **Refresh** at the upper part of the list to load new vehicle definitions.

9.3.8 Shift Settings

This paper introduces the configuration of related Steps of parking shift.

9.3.8.1 Add New

Operating Steps:

Step 1: In the **Parking** module, select "**Parking Basic Management > Shift Setting**".

Step 2: In the **Shift Setting** interface, click **Add New** to fill in relevant parameters, as shown in Figure 9-14. Please refer to Table 9-15 for parameter description.

The screenshot shows a 'New' dialog box with the following fields and controls:

- Shift Name***: A text input field.
- Guard Booth Name***: A dropdown menu.
- Start Time***: A time selection field showing '00 : 00 : 00'.
- End Time***: A time selection field showing '00 : 00 : 00'.
- Cross Day**: A checkbox.
- OK** and **Cancel** buttons at the bottom.

Figure 9-14 New Shift Interface

Parameter	Description
Shift name	Distinguish the difference between shifts by setting the device name
Name of Guard Booth	Distinguish the differences between booths by setting device names
Start time	Select the time when the shift starts
End time	Select the time when the shift ends
Across the sky	Is the shift time set across days

Table 9-15 Shift Parameter Description

Step 3: Click **OK** to complete the setting of adding shift settings.

9.3.8.2 Edit

Click a channel name or **Edit** in the operation column to go to the Edit page. Modify and click **OK** to save modifications.

9.3.8.3 Delete

Select one or more channels and click **Delete** at the upper part of the list and click **OK** to delete the selected channels. Click **Cancel** to cancel the operation or click **Delete** in the operation column to delete a shift setting.

9.3.8.4 Refresh

Click **Refresh** at the upper part of the list to load new shift settings.

9.3.9 Manual Release Reason

A manual release reason must be selected when the manual release function is used on the online monitoring page.

9.3.9.1 Add New

Operating Steps:

Step 1: In the Parking module, select "**Parking Basic Management > Manual Release Reason**"

Step 2: In the **Manual Release Reason** interface, click **Add New** to fill in relevant parameters, as shown in Figure 9-16. Please refer to Table 9-17 for parameter description.

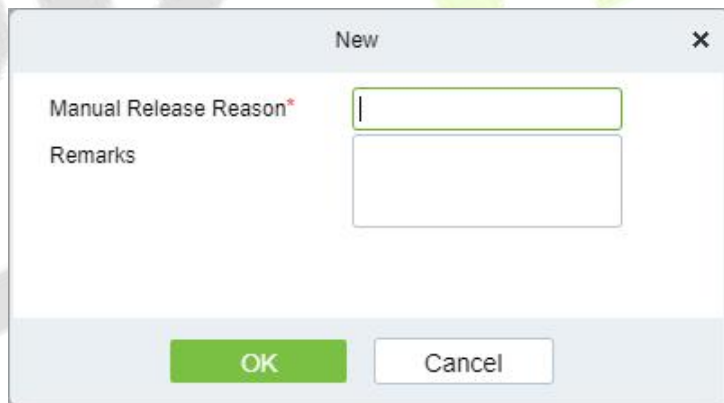

Figure 9-16 New Manual Release Reason Interface

Parameter	Description
Shift Name	Distinguish the difference between shifts by setting the device name
Name Of Guard Booth	Distinguish the differences between booths by setting device names
Start Time	Select the time when the shift starts
End Time	Select the time when the shift ends
Across the Sky	Is the shift time set across days

Table 9-17 for Manual Release Reason parameter description

9.3.9.2 Edit

Click a channel name or **Edit** in the operation column to go to the Edit page. Modify and click **OK** to save modifications.

9.3.9.3 Delete

Select one or more channels and click **Delete** at the upper part of the list and click **OK** to delete the selected channels. Click **Cancel** to cancel the operation or click **Delete** in the operation column to delete a manual release reason.

9.3.9.4 Refresh

Click **Refresh** at the upper part of the list to load new Manual Release Reason.

9.4 Charge Management

This paper introduces the related configuration of parking charge management, mainly setting the charging rules of various car types in the parking lot and the discount strategy of merchants.

9.4.1 Fixed Cars Are Charging Rules

This paper introduces the operation Steps of periodic charging rules for fixed cars in.

9.4.1.1 Add New

Operating Steps:

Step 1: In the **Parking** module, select "**Charge Management > Fixed Car Charge Rules**"

Step 2: In the fixed car charging rules interface, click **Add New** and fill in the corresponding parameters, as shown in Figure 9-18. Please refer to Table 9-19 for parameter description.

Figure 9-18 Fixed Car Charge Rules Interface

Parameter	Description
Name of Fixed Car Charge	Set the name of the charging standard for fixed cars, which cannot be repeated.
Car Type	Select the car type corresponding to the fixed car charging standard, and each car type can only be set once.
Periodic Type	Fixed car charging cycle type, monthly/daily.
Period	Set the cycle time, that is, the effective time of the fixed car.
Amount	Set the amount charged.

Table 9-19 Parameter Description of Fixed Car Charging Rules

9.4.1.2 Edit

Click a fixed charge name or **Edit** in the operation column to go to the Edit page. Modify and click **OK** to save modifications.

9.4.1.3 Delete

Select one or more temporary vehicle charge and click **Delete** at the upper part of the list and click **OK** to delete the selected temporary vehicle charge. Click **Cancel** to cancel the operation or click **Delete** in the operation column to delete a single fixed vehicle charge.

9.4.1.4 Refresh

Click **Refresh** at the upper part of the list to load new fixed vehicle charge.

9.4.2 Temporary Car Charging Rules

This paper introduces the Step configuration of temporary car charging rules in.

9.4.2.1 Add New

Operating Steps:

Step 1: In the **Parking** module, select "**Parking Charge Management > Temporary Car Charge Rules**".

Step 2: In the Temporary Car Charge Rules interface, click **Add New** and fill in the corresponding parameters, as shown in Figure 9-20. Please refer to Table 9-21 for parameter description.

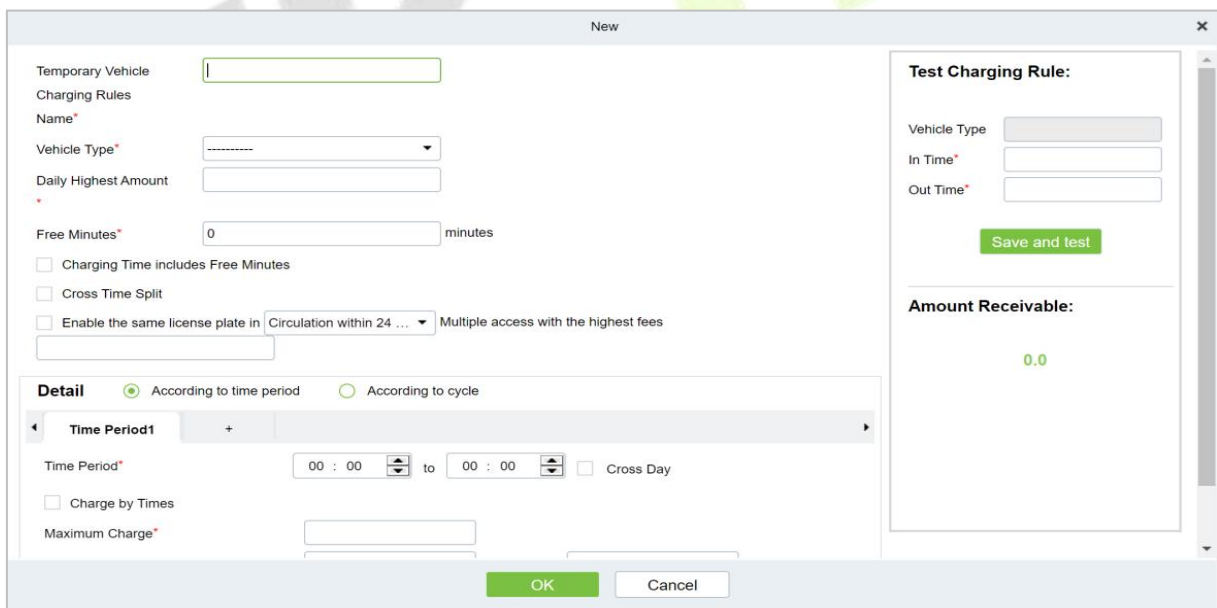

Figure 9-20 Temporary Car Charge Rules Interface

Parameter	Description
Name of Temporary Car Charging Rules	Set the name of temporary car charging rule, which cannot be duplicated.
Car Type	Select the vehicle type corresponding to the charging standard.
Maximum Amount for The Whole Day	The maximum charge within one day (for example, 10 yuan per hour, 240 yuan for a full day; If the maximum charge amount for the whole day is set to 100 yuan, just charge 100 yuan).

Parameter	Description
Free Minutes	There is no charge for parking time within this value range.
Billing Time Includes Free Minutes	<ul style="list-style-type: none"> • Check this item, assuming that the free minute is 30 minutes, and the parking time is 31 minutes. If the parking time exceeds the free minute, the parking time will be charged according to 31 minutes at this time. • If this item is not checked, assuming that the free minute is 30 minutes and the parking time is 31 minutes, if it exceeds the free minute, the parking time at this time is 1 minute (31 minutes minus 30 minutes).
Intertemporal Splitting	<p>Suppose that the charge for period 1 is set at 1 yuan every 15 minutes from 9:00 to 10:00, the charge for period 2 is set at 10 yuan every 15 minutes from 10:00 to 11:00, and the parking time is from 9:43 to 10:30.</p> <ul style="list-style-type: none"> • If this item is not checked, 1 yuan will be charged from 9:43 to 9:58, and if it is only two minutes and less than 15 minutes from 9:58 to 10:00, it will be supplemented from 10:00 to 10:13, then charged according to time period 2 from 10:13 to 10:28, and so on. • If this item is checked, 1 yuan will be charged from 9:43 to 9:58, only two minutes will be less than 15 minutes from 9:58 to 10:00, 1 yuan will be charged according to time period 1, time period 2 will be charged from 10:00 to 10:15, and so on.
Enable The Same License Plate to Enter and Leave the Maximum Charge for Multiple Times in A Cycle of 24 Hours (24 Hours on Natural Days)	That is, rolling charges. If the accumulated fees for the same license plate entering and leaving the parking lot for many times exceed this value, no fees will be charged within the set period. The cycle can be set as 24 hours on a natural day or 24 hours on a cycle: 24 hours on a natural day refers to 0:00-24: 00; Cycle 24 hours refers to the time from the admission time to the next day.
By Time Period	<ul style="list-style-type: none"> • Time period: Set the charging standards for different time periods, and check the cross-day, but to ensure that the cumulative sum of all time periods is 24 hours, multiple time periods can be added, and the time periods remain continuous. • Charge by time: If this item is checked, the first time charge, the amount of unit time charge cannot be filled in, only the highest charge is charged, and the fee set in "Maximum Charge" is charged every time; If this item is not checked, the fee will be charged according to the first time charge, and the remaining time exceeding the first time charge setting will be charged according to the unit time; If the first time charge is not set, the charge will be charged directly according to the unit time, and the unit minute must be a multiple of 15. If the charge exceeds the charge set in the "Maximum Charge", it will be charged according to the maximum charge amount. • First time charge: Set the first time within how many minutes, the amount of charge. • Maximum charge: the maximum amount of charge in the setting period. • Charge amount per unit time: Set the charge amount for how many minutes in this time period.
Periodically	<ul style="list-style-type: none"> • Cycle: From the admission time, the next 1440 minutes (24 hours) can be divided into multiple cycle charging standards.

Parameter	Description
	<ul style="list-style-type: none"> • Charge by time: set whether to charge by time in the cycle. After checking, you can only set the maximum charge amount in the cycle, but you cannot set the charge amount per unit time. • Maximum charge: the maximum amount of charge in the setting period. • Charge amount per unit time: Set the charge amount for how many minutes within the minutes of the cycle.

Table 9-21 Parameter Description of Temporary Car Charging Rules

9.4.2.2 Edit

Click a temporary charge name or **Edit** in the operation column to go to the Edit page. Modify and click **OK** to save modifications.

9.4.2.3 Delete

Select one or more temporary vehicle charge and click **Delete** at the upper part of the list and click **OK** to delete the selected temporary vehicle charge. Click **Cancel** to cancel the operation or click **Delete** in the operation column to delete a single temporary vehicle charge.

9.4.2.4 Refresh

Click **Refresh** at the upper part of the list to load new temporary vehicle charge.

9.4.3 Overtime Charging Rules

This paper introduces the operation Steps of charging rules when vehicles time out in.

9.4.3.1 Add New

Operating Steps:

Step 1: In the **Parking** module, select **Parking Charge Management > Overtime Charge Rules**.

Step 2: In the **Overtime Charge** Rule interface, click **Add New** and fill in the corresponding parameters, as shown in Figure 9-22. Please refer to Table 9-23 for parameter description.

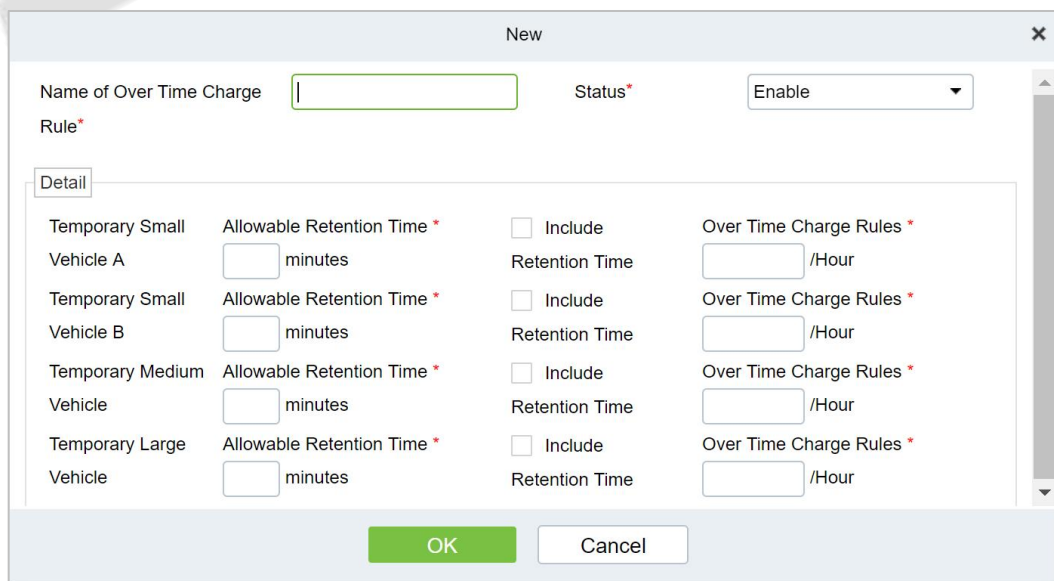

Figure 9-22 Interface of Timeout Charging Rules

Parameter	Description
Overtime Charge Standard	Set the name of timeout charging standard, which cannot be duplicated.
Status	Select whether to enable the charging standard.
Detailed Settings	Set the allowed detention time of each temporary vehicle type after the central payment and the charging standard after exceeding the time.
Allowable Residence Time	The detention time allowed in the garage after the central payment; In case of overtime, you need to charge again.
Including Residence Time	Assume that the allowed detention time is 30 minutes, and the detention time is 31 minutes after payment. If this item is checked, it will be charged according to the timeout of 31 minutes; If this item is not checked, it will be charged according to the timeout of 1 minute.
Overtime Charging Rules	The billing standard for exceeding the allowable residence time.

Table 9-23 Parameter Description of Overtime Charge Rules

9.4.3.2 Edit

Click a name or **Edit** in the operation column to go to the Edit page. Modify and click **OK** to save modifications.

9.4.3.3 Delete

Select one or more temporary vehicle charge and click **Delete** at the upper part of the list and click **OK** to delete the selected temporary vehicle charge. Click **Cancel** to cancel the operation or click **Delete** in the operation column to delete a singlover time charging rules.

9.4.3.4 Refresh

Click **Refresh** at the upper part of the list to load new over time charging rules.

9.4.4 Discount Strategy

This paper introduces the Step configuration of parking discount strategy for parking discount.

9.4.4.1 Add New

Operating Steps:

Step 1: In the **Parking** module, select **Parking Charge Management > Discount Strategy**.

Step 2: In the discount policy interface, click **Add New** and fill in the relevant parameters, as shown in Figure 9-24. Please refer to Table 9-25 for parameter description.

Figure 9-24 New Discount Policy Interface

Parameter	Description
Policy Name	Set the name of discount policy, which cannot be duplicated.
Discount Type	Select the discount type: <ul style="list-style-type: none"> Free, no charge. The amount of reduction and exemption, the cost is directly deducted from the fixed amount. Reduce minutes, subtract minutes from parking time and then charge. Percentage of reduction and exemption, percentage of expense deduction.
Amount of Relief	At present, the discount type is reduction amount, and the corresponding field name is reduction amount; If it is another type, it corresponds to the corresponding unit. When the discount type is free, this item is not filled in.

Table 9-25 Discount Strategy Parameter Description

9.4.4.2 Edit

Click a name or **Edit** in the operation column to go to the Edit page. Make modifications and click **OK** to save modifications.

9.4.4.3 Delete

Select one or more discount policies and click **Delete** at the upper part of the list and click **OK** to delete the selected discount policies. Click **Cancel** to cancel the operation or click **Delete** in the operation column to delete a single discount strategy.

9.4.4.4 Refresh

Click **Refresh** at the upper part of the list to load new discount policies.

9.4.5 Business Management

This paper introduces the operation Steps of merchant management in.

9.4.5.1 Add New

Operating Steps:

Step 1: In the **Parking** module, select "**Parking Charge Management > Business Management**".

Step 2: In the **Business Management** interface, click **Add New** fill in the corresponding parameters, as shown in Figure 9-26. Please refer to Table 9-27 for parameter description.

Figure 9-26 Business Management New Interface

Parameter	Description
Merchant Name	Set the merchant’s name, which cannot be duplicated.
Discount Method	Choose a discount strategy.
Contact Person	Set up merchant contacts.
Merchant Telephone Number	Set the contact number of the merchant.
Merchant Address	Set the merchant contact address.

Table 9-27 Description of Business Management Parameters

9.4.5.2 Edit

Click a name or **Edit** in the operation column to go to the Edit page. Modify and click **OK** to save modifications.

9.4.5.3 Delete

Select one or more vendors and click **Delete** at the upper part of the list and click **OK** to delete the selected vendors. Click **Cancel** to cancel the operation or click **Delete** in the operation column to delete a single vendor.

9.4.5.4 Refresh

Click **Refresh** at the upper part of the list to load new vendors.

9.4.6 Financial Reconciliation

This paper introduces the operation Steps of accounting reconciliation in.

Operating Steps:

Step 1: In the **Parking** module, select "**Parking Charge Management > Financial Reconciliation**".

Step 2: In the account reconciliation interface, click **Reconciliation**, as shown in Figure 9-28. Please refer to Table 9-29 for parameter description

Figure 9-28 Accounting Reconciliation New Interface

Parameter	Description
Duty Officer Name	Duty officer name
Duty Officer Id	Duty officer ID
Duty Starts Time	Duty starts time
Duty End Time	Duty end time
The Number of Free Release Vehicle	Number of vehicles released free of charge
The Number of Manual Releases	Number of vehicles released manually
Confirmor	Reconciliation personnel
Advance Amount	Amount prepaid to the guard booth (for changes).
Turnover	Paid amount
The Total Amount	Advance amount + Turnover
The Actual Amount	Amount entered by the duty officer during the shift change.
Confirm Time:	Current time
Confirm Amount:	Amount confirmed by the reconciliation personnel
Remark	Remark to be added.

Table 9-29 Parameter Description of Accounting Reconciliation

9.5 Vehicle Management

9.5.1 License Plate Registration

This paper introduces the operation Steps of License.Plate Registration.

9.5.1.1 Add New

Operating Steps:

Step 1: In the **Parking** module, select "**Vehicle.Management > License.Plate Registration**".

Step 2: In the License.Plate Registration interface, click **Add New**, as shown in Figure 9-30. Please refer to Table 9-31 for parameter description

Figure 9-30 License.Plate Registration New Interface

Parameter	Description
Name	Enter the person's name
License Plate	License Plate numbers to be added for registration

Table 9-31 for parameter description of License.Plate Registration

9.5.1.2 Edit

Click **Edit** at the end of each line or click the corresponding Personnel ID and modify personnel license plate registration information in the Edit dialog box.

9.5.1.3 Delete

Select one or more license plate registration information and click **Delete** at the upper part of the list and click **OK** to delete the selected registration information. Click **Cancel** to cancel the operation or click **Delete** in the operation column to delete a single registration information.

9.5.1.4 Download License Plate Import Template

This function will help you to download the licence plate import template.

A	B
License Plate Import Template	
Personnel ID	License plate number (multiple license plates, separated)

Figure 9-31(1) License.Plate Download Template

9.5.1.5 License Plate Import

This function will help you to upload the licence plate import template.

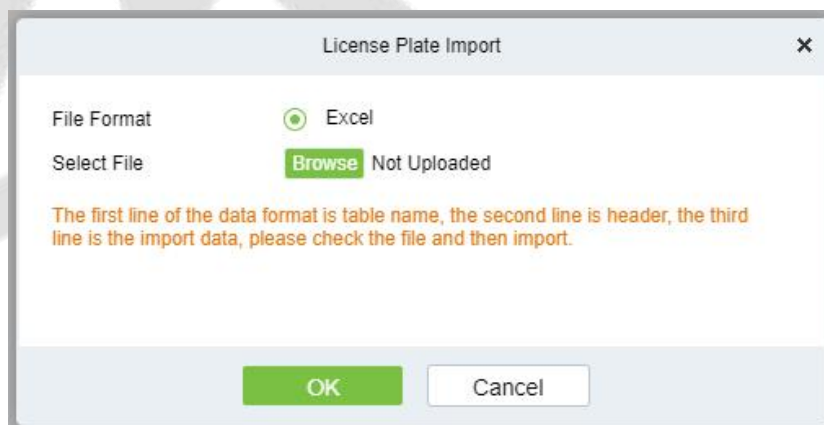

Figure 9-32 License.Plate Registration Import Interface

9.5.2 Vehicle Authorization

This paper introduces the configuration of vehicle authorization Steps in. Only authorized vehicles can normally use the parking module process.

9.5.2.1 Add New

Operating Steps:

Step 1: In the **Parking** module, select **Vehicle Management > Vehicle Authorization**.

Step 2: Click **Add** and fill in the relevant parameters, as shown in Figure 9-33. Please refer to Table 9-34 for parameter description.

Figure 9-33 Vehicle Authorization Interface

Parameter	Description
Name	In the input box, enter one or more characters contained in the name or number of the owner, and you can find the owner vaguely.
Parking Space Number	Enter the total number of parking spaces in this area
Entrance And Exit Area	Set the Entrance and Exit Area where this license plate can pass. After selecting the parking space number, filter and only display the Entrance and Exit Area of the parking lot area to which the parking space number belongs.
Car Type	Select the vehicle type to which the vehicle belongs.
Fixed Charge Name	Unique name of a fixed vehicle charge
Start Time/End Time	Refers to the time/deadline for authorizing the license plate to take effect. If the fixed car charging standard is enabled, this parameter is filled in by default.
Amount Collected	Record the fees charged for this authorization; If the fixed car charging standard is enabled, this parameter is filled in by default.

Table 9-34 Description of Vehicle Authorization Parameters

Step 3: Click **OK** to complete the setting of vehicle authorization.

9.5.2.2 Fixed vehicle Batch Authorization

On the Vehicle Management page, click Fixed vehicle Batch Authorization. The Fixed vehicle Batch Authorization page is displayed as in the following figure:

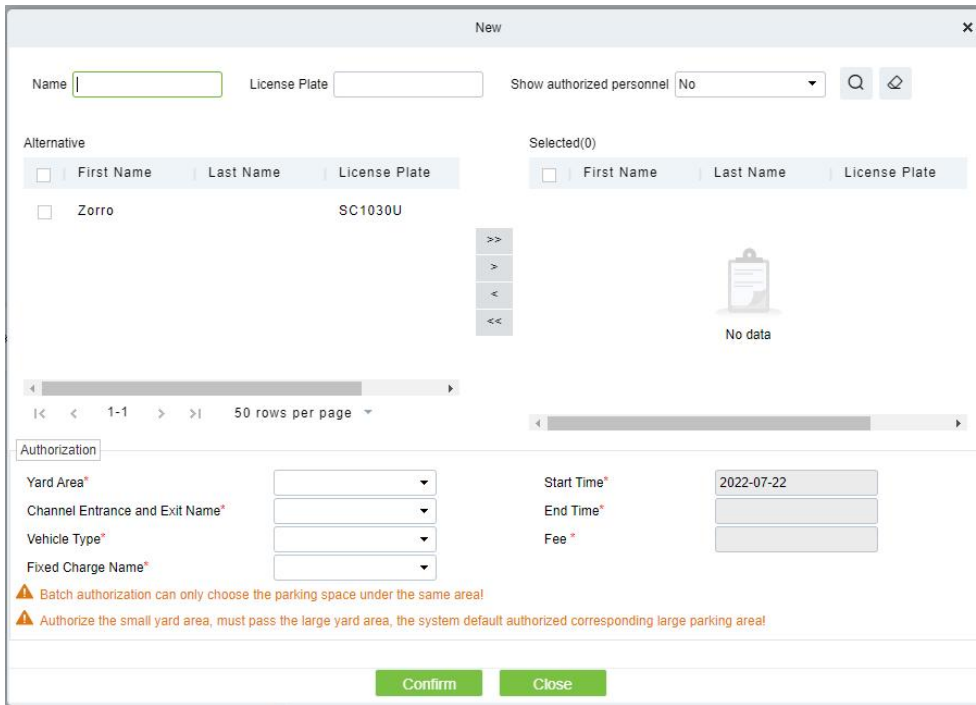

Figure 9-35 Fixed vehicle Batch Authorization New Interface

Select one or more license plates to be authorized from the list on the left. Click > in the middle to add the license plate to the list on the right. Enter the vehicle type, entrance, and exit area, fee, start time and end time in the Authorization area, and click OK to save the information and authorize fixed vehicles in batches.

9.5.2.3 Temporary Vehicle Authorization

On the **Vehicle Management** page, click **Temporary Vehicle Authorization**, the Temporary Vehicle Authorization page is displayed as shown in the following figure. Only the entrance and exit areas to be authorized need to be selected.

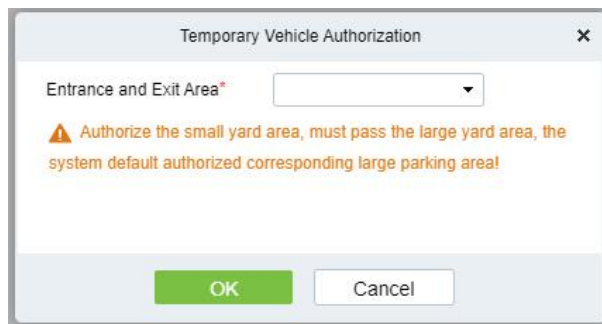

Figure 9-36 Temporary vehicle Authorization Interface

9.5.2.4 Fixed Vehicle Authorization: Delete

Select multiple check boxes in the first column of the license plate list and click Delete to cancel license plates in batches or click Delete at the end of each line to cancel a single license plate.

9.5.2.5 Export

Device information can be exported in EXCEL, PDF, CSV file format.

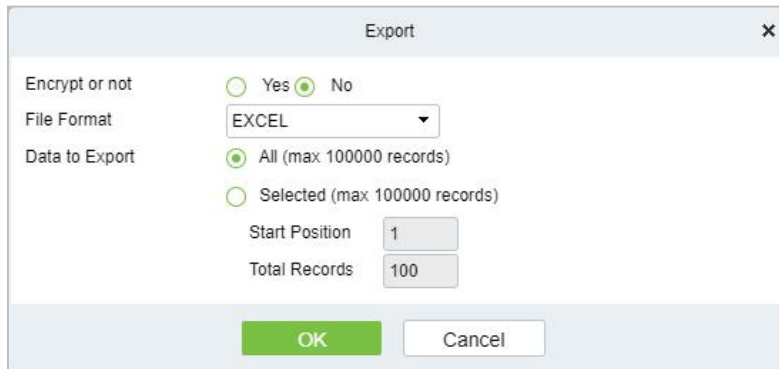

Figure 9-37 Fixed vehicle Authorization Export

9.5.3 Fixed Vehicle Extension

9.5.3.1 Fixed Vehicle Authorization: Delete

Select multiple check boxes in the first column of the license plate list and click **Delete** to cancel license plates in batches or click **Delete** at the end of each line to cancel a single license plate.

9.5.3.2 Batch Extension

Select a fixed license plate for which the valid time needs to be extended and click **Batch Extension** at the end of a fixed license plate. The **Batch Extension** page is displayed.

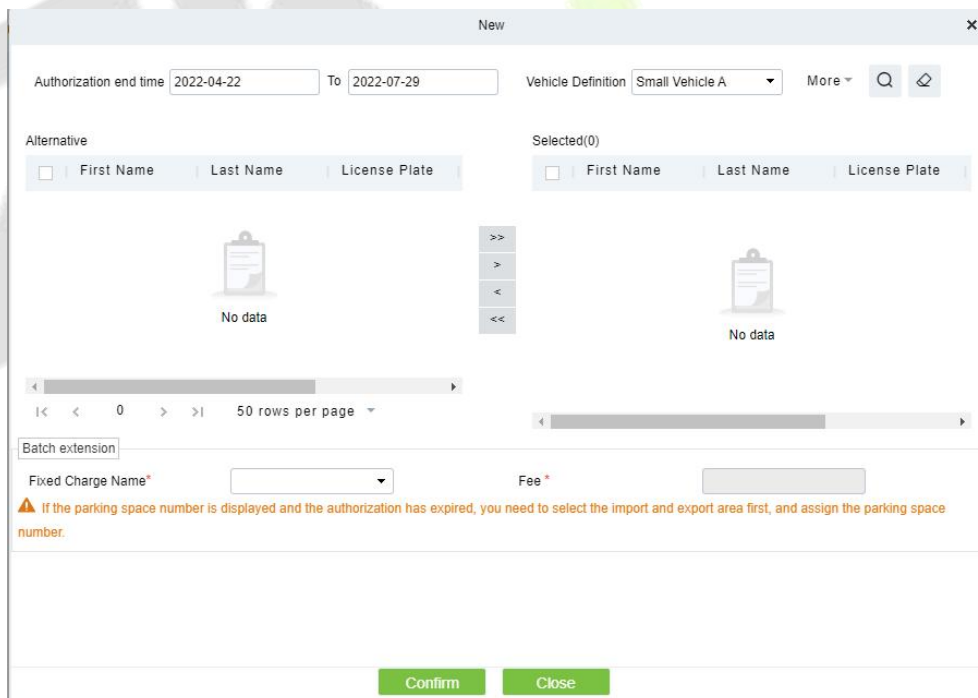

Figure 9-38 Fixed vehicle Authorization Batch Extension

Set Extended Deadline and Fee. Click OK to save and exit.

9.5.4 Block&Allow List Management

9.5.4.1 Add New

Operating Steps:

Step 1: In the **Parking** module, select **Vehicle Management > Block&Allow List Management**.

Step 2: Click **Add New** and fill in the relevant parameters, as shown in Figure 9-39. Please refer to Table 9-40 for parameter description.

Figure 9-39 Block&Allow List Management New Interface

Parameter	Description
License Plate	License plate numbers to be added to the blocklist or allowlist
License Plate Type	The value can be block list or allowlist
Start Time/End Time	Time when the allowlist takes effect & expires (This parameter is not available for the blocklist).

Table 9-40 Description of Block&Allow List Management Parameters

9.5.4.2 Edit

Click a **license plate** number or **Edit** in the operation column to go to the Edit page. Make modifications and click **OK** to save modifications.

9.5.4.3 Delete

Select one or more license plate numbers and click **Delete** at the upper part of the list and click **OK** to delete the selected license plate numbers. Click **Cancel** to cancel the operation or click **Delete** in the operation column to delete a single license plate number.

9.5.4.4 Refresh

Click **Refresh** at the upper part of the list to load the latest blocklist and Allowlist.

9.5.4.5 Synchronize Blocklist

Click **Synchronize Blocklist**, click **OK** to synchronize all blocklists, click **Cancel** to cancel.

When the device is off-line, the device will automatically synchronize blocklist and broadcast voice. It should be noted that the device must be equipped with an SD card.

9.5.4.6 Synchronize Allowlist

Click **Synchronize Allowlist**, click **OK** to synchronize all Allowlists, click **Cancel** to cancel.

When the device is off-line, the device will identify the Allowlist synchronized and automatically open the gate. It should be noted that the device must be equipped with an SD card.

9.6 Report Management

9.6.1 Vehicle Inside

9.6.1.1 Remove

Remove from Device function lets you to remove or eliminate the transmitted Work Codes from the Device.

9.6.1.2 Export

Device information can be exported in EXCEL, PDF, CSV file format.

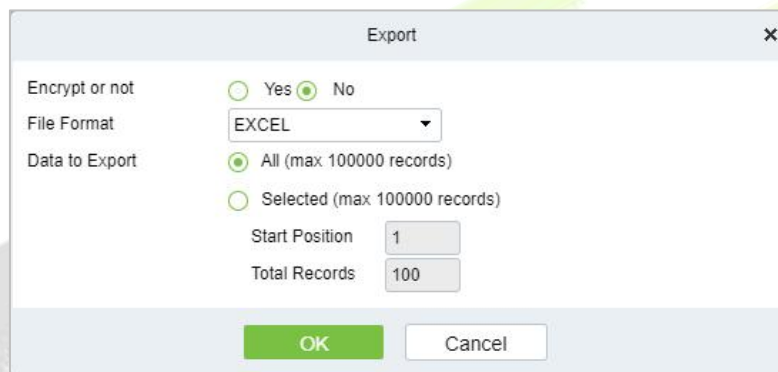

Figure 9-41 vehicle Inside Export Interface

9.6.1.3 License Plate Correction

Make modifications of the License Plate Number.

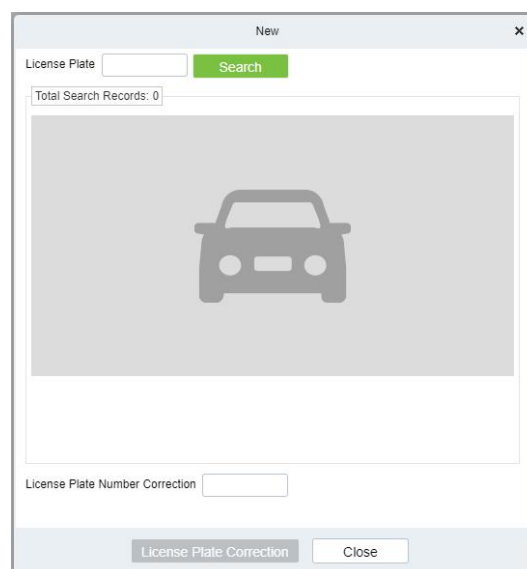



Figure 9-42 License Plate Correction

9.6.2 Entry Record

It will provide the details of the vehicle which entered into the parking.

Click **Report Management** > **Entry Record**. Select the desired time period, vehicle owner and license plate number, and click  to query Entry records. Click **More** to query based on other conditions.

9.6.2.1 Export

Device information can be exported in EXCEL, PDF, CSV file format.

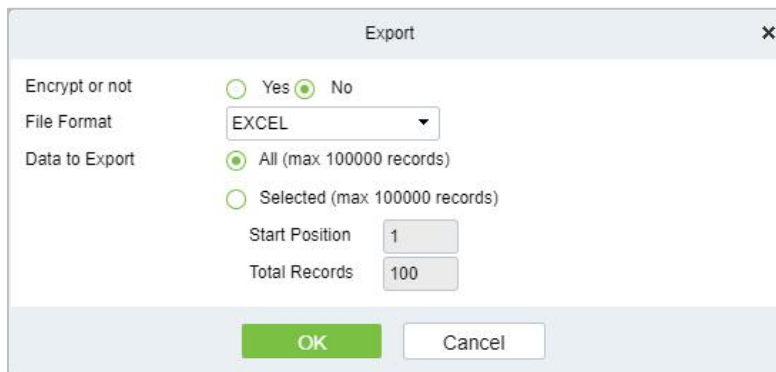



Figure 9-43 Entry Record of Export Interface

9.6.3 Exit Record

It will provide the details of the vehicle which exited out of the parking.

Click **Report Management** > **Exit Record**. Select the desired time period, vehicle owner and license plate number, and click  to query Exit records. Click **More** to query based on other conditions.

9.6.3.1 Export

Device information can be exported in EXCEL, PDF, CSV file format.

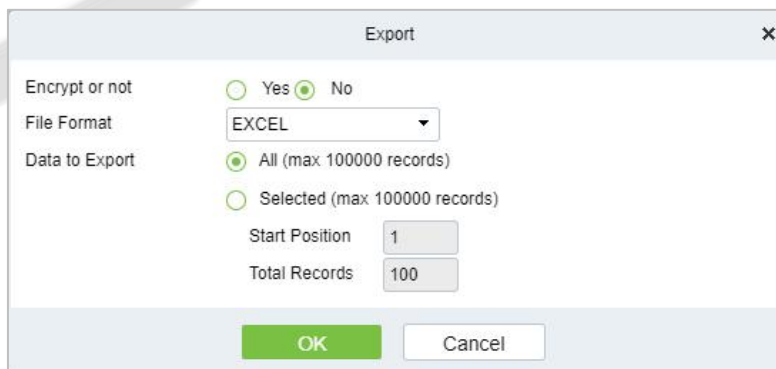

Figure 9-44 Exit Record of Export Interface

9.6.4 Charge Record

The Charge Record Details module provides reports of charging information of all exit vehicles (records with fee of 0 are also generated for fixed vehicles and charging-free temporary vehicles).

9.6.4.1 Export

Device information can be exported in EXCEL, PDF, CSV file format.

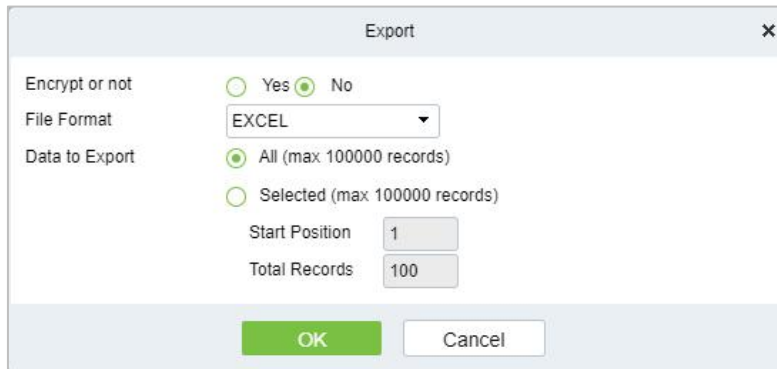

Figure 9-45 Export interface for Charge Record

Choose **Report Management > Charge Details**. Select the desired time period and operator name and click \ to query charging details. Click **More** to query based on other conditions. The page is shown in the following figure.

9.6.5 Expired Vehicle

9.6.5.1 Incoming Unusual Vehicles

It will provide the details of the vehicle which incoming unusually of the parking.

Click **Report Management > Incoming Unusual Vehicles**. Select the desired time period, vehicle owner and license plate number, and click 🔍 to query Exit records. Click **More** to query based on other conditions.

9.6.5.2 Export

Device information can be exported in EXCEL, PDF, CSV file format.

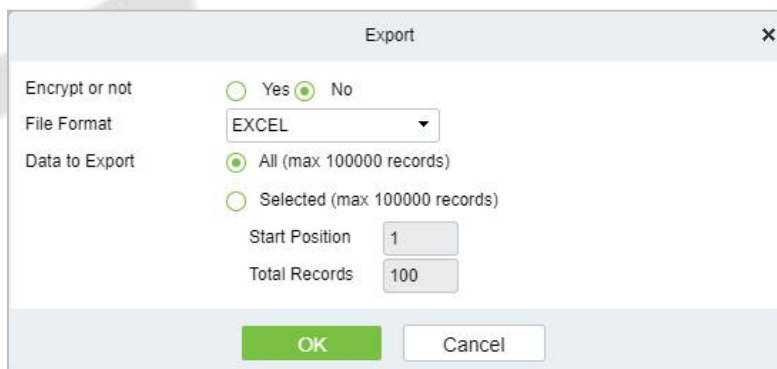

Figure 9-46 Incoming Unusual Vehicles of Export Interface

9.6.6 Fixed Vehicle Authorization Record

It will provide the details of the vehicle which fixed authorization records of the parking.

Click **Report Management > Fixed Vehicle Authorization Record**. Select the desired time period, vehicle owner and license plate number, and click 🔍 to query Exit records. Click **More** to query based on other conditions.

9.6.6.1 Export

Device information can be exported in EXCEL, PDF, CSV file format.

Figure 9-47 Fixed vehicle Authorization Record of Export Interface

9.6.7 Device Operation Record

IP Address	Device Name	Operating Time	Operation Result	Operation Type	Object	Operations
<input checked="" type="checkbox"/>	192.168.20.254	d	2022-07-18 03:42:11	Turn off the device	The operation succeec	
<input type="checkbox"/>	192.168.20.254	d	2022-07-13 03:26:44	Connecting device	The operation failed!	
<input type="checkbox"/>	192.168.20.254	d	2022-07-08 03:56:13	Connecting device	The operation failed!	
<input type="checkbox"/>	192.168.20.254	d	2022-07-07 09:04:25	获取功能参数	The operation failed!	
<input type="checkbox"/>	192.168.20.254	d	2022-07-04 12:29:01	Get device parameters	The operation failed!	
<input type="checkbox"/>	192.168.20.254	d	2022-07-04 12:28:51	Connecting device	The operation failed!	
<input type="checkbox"/>	192.168.20.254	LPR-300 Bangalore	2022-07-04 12:17:27	Turn off the device	The operation succeec	
<input type="checkbox"/>	192.168.20.254	LPR-300 Bangalore	2022-07-04 11:54:36	Synchronize Time	The device is offline, i	
<input type="checkbox"/>	192.168.20.254	LPR-300 Bangalore	2022-07-04 11:54:25	Enable	The device is offline, i	

Figure 9-47.1 Device Operation Record Interface

9.6.7.1 Delete

Select one or more device operation record and click **Delete** at the upper part of the list and click **OK** to delete the selected device operation record. Click **Cancel** to cancel the operation or click **Delete** in the operation column to delete a single device operation record.

9.6.8 Handover Statistics

The Handover Record provides reports of handover records.

Choose **Report Management > Handover Statistics**. Select the desired time period and operator name and click \ to query handover records. Click **More** to query based on other conditions. The page is shown in the following figure.

9.6.8.1 Export

Device information can be exported in EXCEL, PDF, CSV file format.

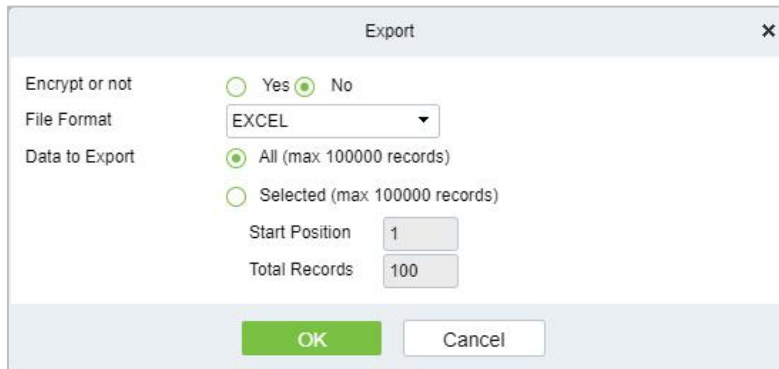

Figure 9-48 HandOver Statistics of Export Interface

9.6.9 Daily Income Statistics

The Daily Report provides reports of the total amount of charges per day for each shift in each duty guard booth.

Choose **Report Management > Daily Reports**. Select the desired time period and click \ to query the total amount of charges for each shift in each duty guard booth. The page is shown in the following figure.

9.6.9.1 Export

Device information can be exported in EXCEL, PDF, CSV file format.

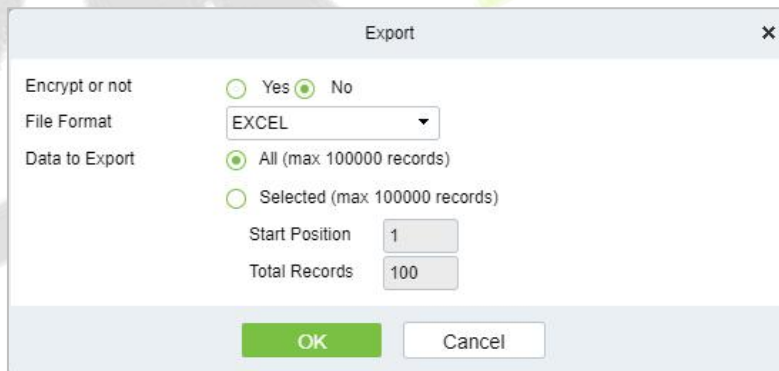

Figure 9-49 Daily Income Statistics of Export Interface

9.6.10 Monthly Income Statistics

The Monthly Report provides statistics of parking fees for each day of the month.

Choose **Report Management > Monthly Reports**. Select the desired time period and click **1A** to query the parking fees the page is shown in the following figure.

9.6.10.1 Export

Device information can be exported in EXCEL, PDF, CSV file format.

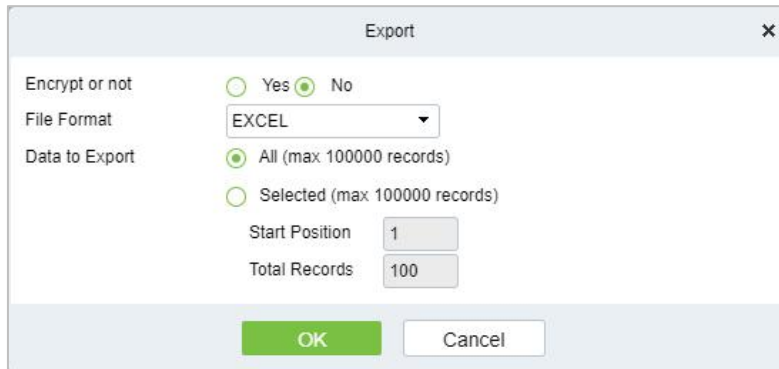

Figure 9-50 Export Interface of Monthly Income Statistics

9.7 Real-Time Monitoring

This paper introduces the configuration of real-time monitoring in parking module and can view the monitoring dynamics in real time in this interface.

9.7.1 Sentry Booth Monitoring

This paper introduces that the configuration of monitoring related information can be viewed in the booth monitoring interface in, and the administrator can view the monitoring dynamics in the booth monitoring interface.

Operating Steps:

Step 1: In the **Parking** module, click "**Parking Real-time Monitoring > Sentry Booth Monitoring**".

Step 2: In the booth monitoring interface, you can view related monitoring videos and events, as shown in Figure 9-51.

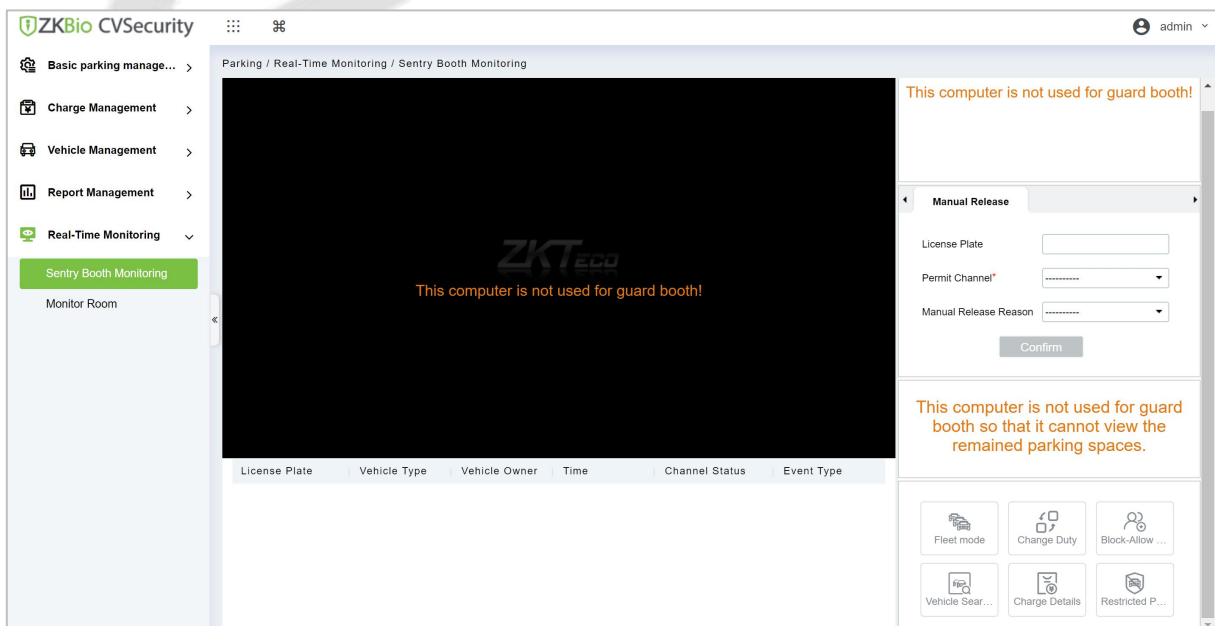

Figure 9-51 Guard Booth Monitoring Interface

9.7.1.1 Manual Release

This paper introduces the manual release function of Guard Booth monitoring, and the administrator can operate the vehicle release in this interface.

Operating Steps:

Step 1: In the **Parking** module, click "**Parking Real-time Monitoring > Box Monitoring > Manual Release**".

Step 2: Under manual release, the administrator can operate vehicle release here, and when the vehicle is not recognized, manual release can be performed, as shown in Figure 9-52.

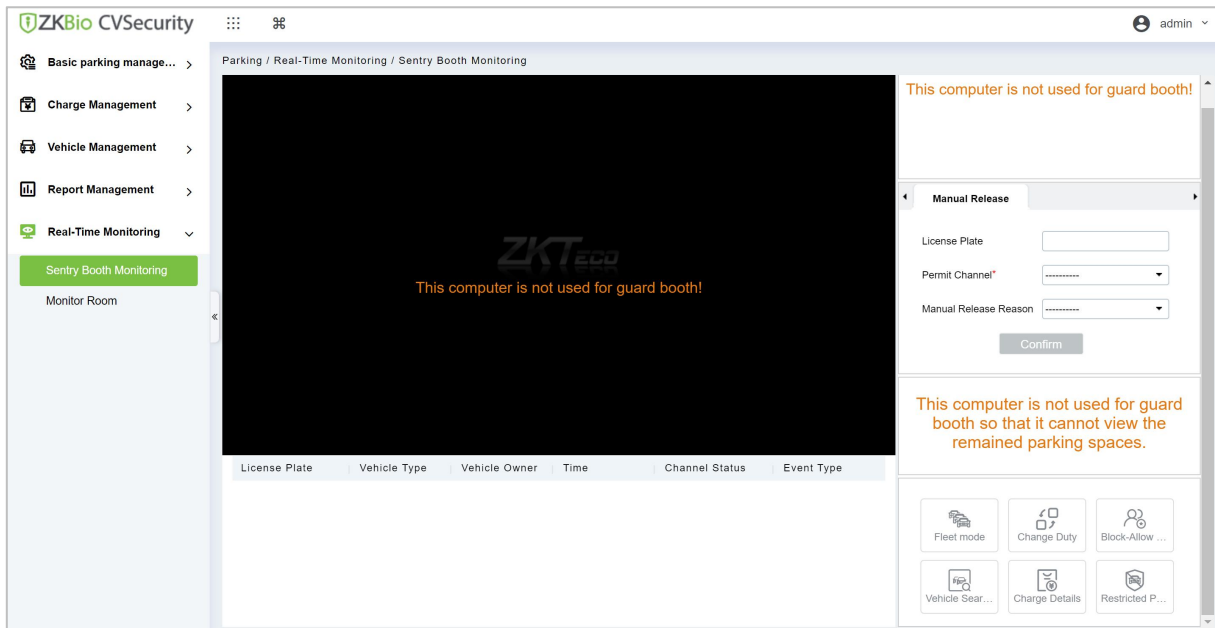

Figure 9-52 Manual Pass Interface

9.7.1.2 Change Shifts

This paper introduces the information configuration of personnel shift change in, where you can view the data information of shift change handover when exchanging shifts.

Operating Steps:

Step 1: In the **Parking** module, click "**Parking Box Monitoring > Shift Change**".

Step 2: Set the relevant shift information, as shown in Figure 9-53, and refer to Table 9-54 for parameter description.

Shift confirmation			
Duty Officer Name	admin	Duty Officer ID	1
Duty start time	2017-05-17 14:20:15	Advance amount*	100
Duty end time	2017-05-17 14:55:44	Turnover	0
The number of free release vehicle	3	The total amount	100
The number of artificial release	0	The actual amount*	100

Figure 9-53 Shift Change Interface

Parameter	Description
-----------	-------------

Parameter	Description
Name of Duty Officer	Show the name of the person on duty
Working Hours	Show the working hours of the personnel on duty
Attendance Checking Hours	Display the attendance checking time of the attendant
Number of Vehicles Released Free of Charge	Number of vehicles allowed to be released free of charge
Number of Manual Switches	Number of times of manual release through manual gate opening
Advance Amount	Such as reserve amount, such as reserve for change
Preferential Amount	Amount of parking discount
Turnover	Business amount generated by parking lot charges
Total Amount	Total amount of car park revenue
Actual Amount	Actual amount of parking lot income (net income)

Table 9-54 Description of Shift Change Parameters

Step 3: Enter the account number and password of the shift changer.

Step 4: Click **OK** to complete the setting of booth shift change.

9.7.2 Monitor Room

This paper introduces that the configuration of monitoring related information can be viewed in the monitoring room interface in, and the administrator can view the monitoring dynamics in the monitoring room interface.

Operating Steps:

Step 1: In the **Parking** module, click "**Parking Real-Time Monitoring > Monitor Room**".

Step 2: You can view relevant monitoring videos and data statistics in the monitoring room interface, as shown in Figure 9-55.

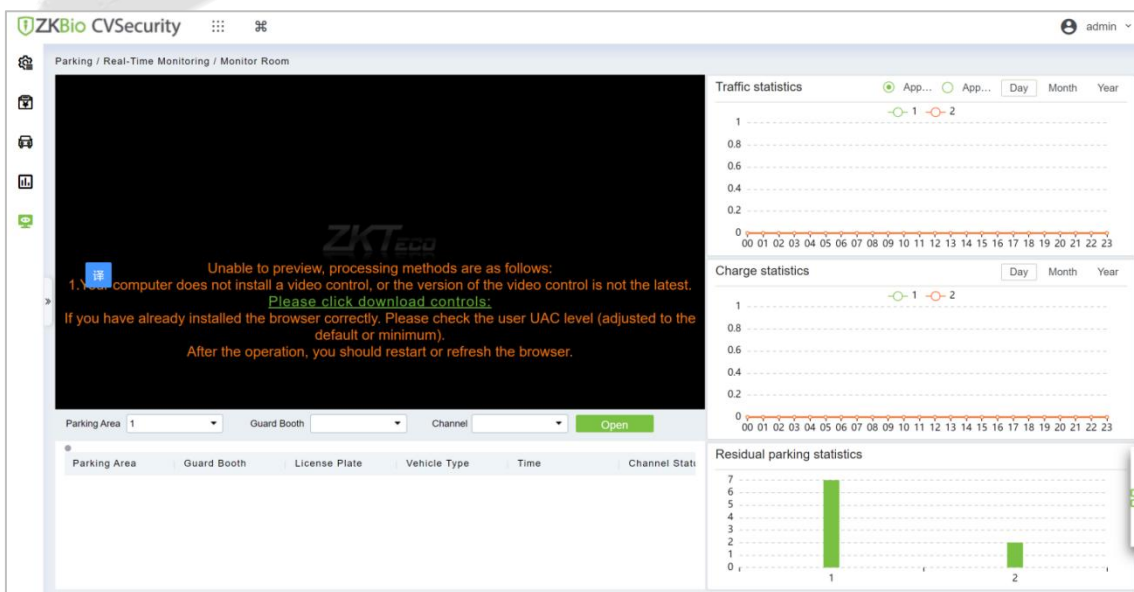

Figure 9-55 Monitoring Room Interface

9.7.2.1 Manual Barrier Opening

This paper introduces the Step configuration that the administrator can open the Barrier manually, which can be used to open the Barrier manually when the vehicle is not recognized.

Operating Steps:

Step 1: In the **Parking** module, click "**Parking Real-time Monitoring > Monitor Room**".

Step 2: In the monitor room interface, click "Open Gate-Enter License Plate Number-Confirm Open Gate", as shown in Figure 9-56.

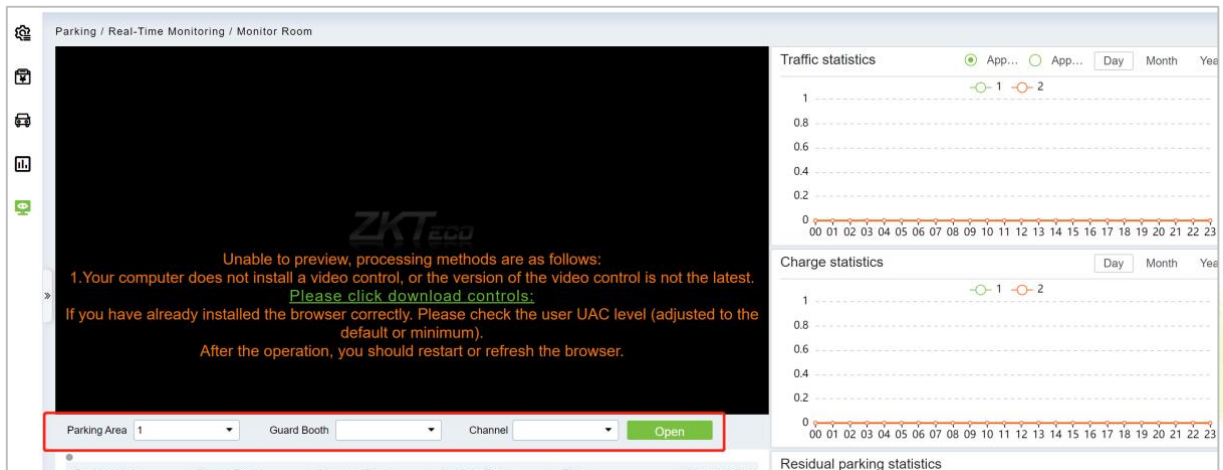

Figure 9-56 Switch Interface

10 Visitor Management

10.1 Operation Scenario

By registering visitor’s certificates, photos and other effective ways, and issuing corresponding Access Control/Elevator control/passage/witness authority, visitors can be managed safely and efficiently.

10.2 Operation Flow

Introduces the configuration process of visitor management business.

The business configuration process of the visitor management business is shown in Figure 10-1.

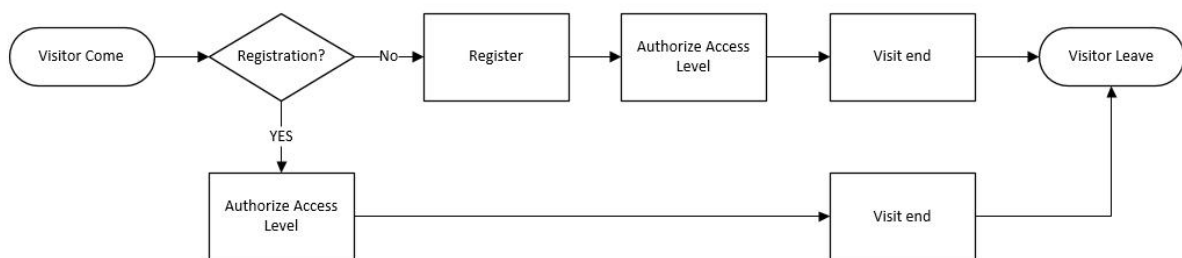

Figure 10- 1 Visitor Configuration Process

10.3 Visitor Registration

10.3.1 Entry Registration

10.3.1.1 Entry Registration

There are two ways to register visitors:

1. PC side (computer)
2. Visiting the passenger plane (ZKBioCVSecurity visits and logs in)

- **PC-Side Registration (Direct Registration)**

This paper introduces the configuration Steps of PC registration (Direct registration) in.

Operating Steps:

Step 1: In the **Visitor** module, select **Visitor Registration > Entry Registration**.

Step 2: In the Entry registration interface, click **Visit Registration** to enter the registration interface for visitor registration, as shown in Figure 10-2.

Figure 10- 2 Direct Register Visitor Interface



Parameter	Description
Host/Visited	Select the visited personnel. Click the input box to filter the query according to the input characters or click the query button to pop up the list of the visited personnel to select the visited personnel.
Visit Department	Select the department the visitor will visit.
Visit Reason	Select the visit reason. You can also input a new reason, and the reason will be added in the Visit Reason list in the Visit Reason of Basic Management .
Certificate Type	Passport, Driving License, ID Card, and Others are available to choose from the drop-down list. If the ID Scan OCR function is activated, visitor information will display automatically after clicking  icon.
Entrance	Select the entry place for the visitor. You can add an entry place in the Entry Place of Basic Management .
Certificate No.	The numbers and letters are legal; the max length is 20.
First Name	Enter the first name of the visitor.
Visitor Quantity	Enter the number of visitors.
Start and End Time	Enter the start and end times of the visit.
Personnel Details	Enter the personnel details.
Capture	The captured photo and certificate photo can be taken separately or at the same time (which can be set in Parameter Settings). If there is a camera (High-Speed Portable HD Doc Scanner) connected to the server, you can click Capture to take the visitors' photos. The browser may block the camera to access, please click  in the IP address bar to select the camera and change the setting to allow access to this page.

Table 10- 1 Description of Parameters of Entry Registration

● **Pc Registration (Second-Generation Id Card Reservation Registration)**

This paper introduces the configuration Steps of Registration through the Visitor Reservation.

Operating Steps:

Step 1: In the **Visitor** module, select **Visitor Reservation > Visitor Reservation**.

Step 2: In the visitor reservation interface, click **New** to complete the reservation registration before visitors visit, as shown in Figure 10-3.

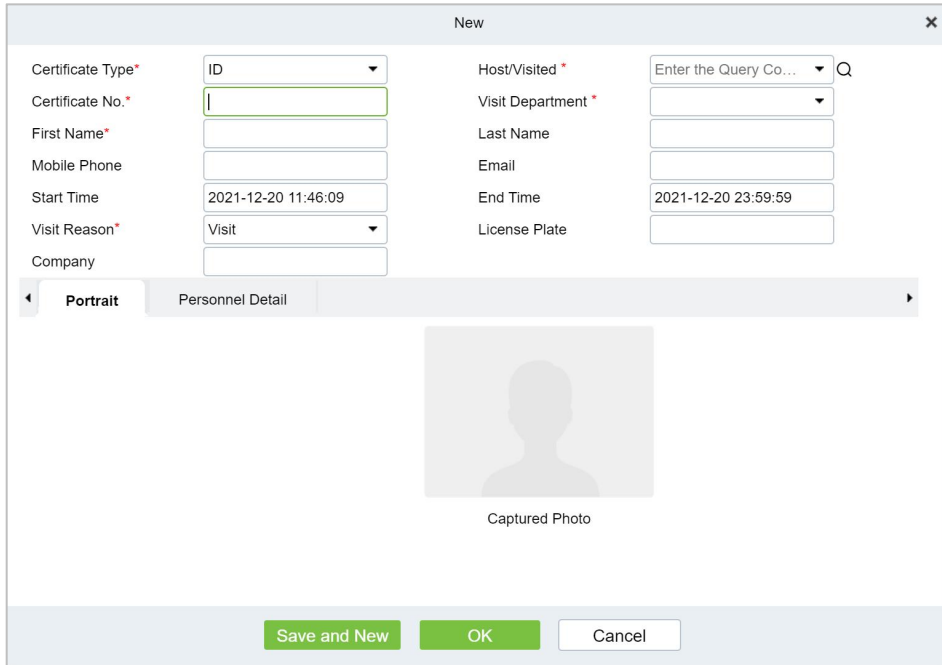

Figure 10- 3 Reservation Interface



Parameter	Description
Host/Visited	Select the visited personnel. Click the input box to filter the query according to the input characters or click the query button to pop up the list of the visited personnel to select the visited personnel.
Visit Department	Select the department the visitor will visit.
Visit Reason	Select the visit reason. You can also input a new reason, and the reason will be added in the Visit Reason list in the Visit Reason of Basic Management .
Certificate Type	Passport, Driving License, ID Card, and Others are available to choose from the drop-down list. If the ID Scan OCR function is activated, visitor information will display automatically after clicking  icon.
Certificate No.	The numbers and letters are legal; the max length is 20.
First Name	Enter the first name of the visitor.
Start and End Time	Enter the start and end times of the visit.
Personnel Details	Enter the personnel details.
Portrait	The captured photo and certificate photo can be taken separately or at the same time (which can be set in Parameter Settings). If there is a camera (High-Speed Portable HD Doc Scanner) connected to the server, you can click Capture to take the visitors' photos. The browser may block the camera to access, please click  in the IP address bar to select the camera and change the setting to allow access to this page.

Table 10-2 Description of Parameters Reservation

Step 3: Select **Visitor Registration > Entry Registration > Entry Registration** to enter the registration interface for visitor registration. Enter the **First Name** to directly obtain the ID number, thus displaying the visitor information of reservation registration, then select the visitor authority, and click **OK** to complete the visit registration, as shown in Figure 10-4.

Figure 10- 4 Second Generation Identity Registration Interface

Parameter	Description
Host/Visited	Select the visited personnel. Click the input box to filter the query according to the input characters or click the query button to pop up the list of the visited personnel to select the visited personnel.
Visit Department	Select the department the visitor will visit.
Visit Reason	Select the visit reason. You can also input a new reason, and the reason will be added in the Visit Reason list in the Visit Reason of Basic Management .
Certificate Type	Passport, Driving License, ID Card, and Others are available to choose from the drop-down list. If the ID Scan OCR function is activated, visitor information will display automatically after clicking icon.
Entrance	Select the entry place for the visitor. You can add an entry place in the Entry Place of Basic Management .
Certificate No.	The numbers and letters are legal; the max length is 20.
First Name	Enter the first name of the visitor.
Visitor Quantity	Enter the number of visitors.
Start and End Time	Enter the start and end times of the visit.
Personnel Details	Enter the personnel details.
Capture	The captured photo and certificate photo can be taken separately or at the same time (which can be set in Parameter Settings). If there is a camera (High-Speed Portable HD Doc Scanner) connected to the server, you can click Capture to take the visitors' photos. The browser may block the camera to access, please click in the IP address bar to select the camera and change the setting to allow access to this page.

Table 10- 2 Description of Parameters of Second Generation Identity Registration

Notes:

For different browsers, the contents of tips are different, the actual browser display prevails, just choose the shared camera, and allow the system to access the camera.

If the entry place supports a network camera, scanner, high camera, it will not pop up this tip.

You can select card number, fingerprint, password, or code scanning for registration (set in the parameter setting).

10.3.1.2 Visitor Cloning

Application scenario: Similar to an entourage copying some information from the previous person, visitors only need to show their credentials and snap photos to complete the registration. It mainly includes the following attributes: Host, visit department, visit reason, Entrance, company, country, visitor level, start time, end time.

Operating Steps:

Step 1: In the **Visitor** module, select **Visitor Registration > Entry Registration**.

Step 2: In the visitor registration interface, click **Visitor Cloning** to enter the registration interface for visitor cloning.

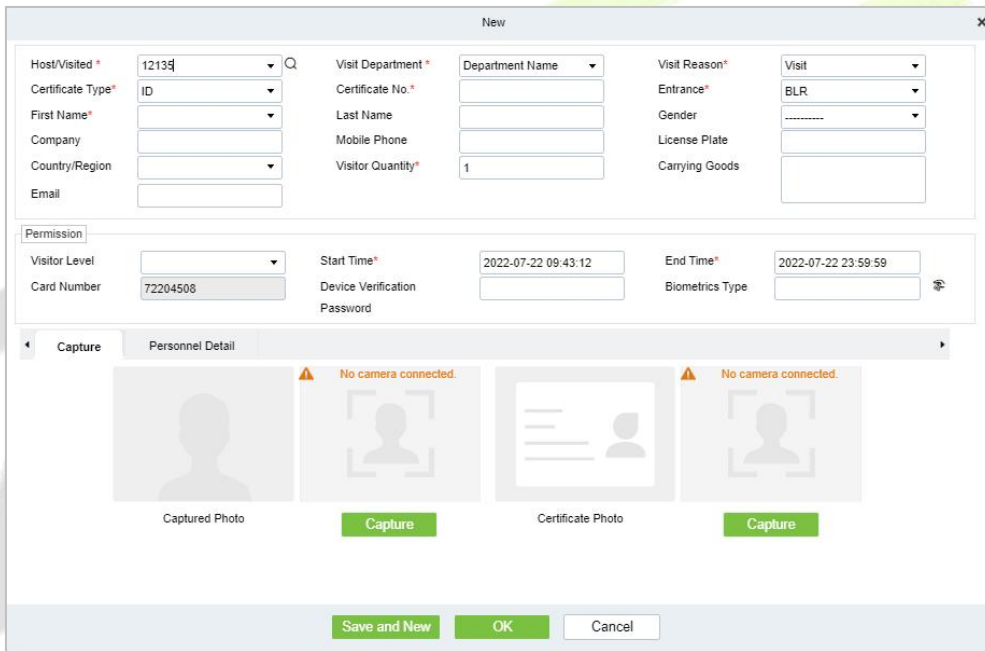



Figure 10- 5 Visitor Cloning interface

Parameter	Description
Host/Visited	Select the department the visitor will visit.
Visit Department	Select the department the visitor will visit.
Visit Reason	Select the visit reason. You can also input a new reason, and the reason will be added in the Visit Reason list in the Visit Reason of Basic Management .
Certificate Type	Passport, Driving License, ID Card, and Others are available to choose from the drop-down list. If the ID Scan OCR function is activated, visitor information will display automatically after clicking  icon.
Entrance	Select the entry place for the visitor. You can add an entry place in the Entry Place of Basic Management .

Parameter	Description
Certificate No.	The numbers and letters are legal; the max length is 20.
First Name	Enter the first name of the visitor.
Visitor Quantity	Enter the number of visitors.
Start and End Time	Enter the start and end times of the visit.
Personnel Details	Enter the personnel details.
Capture	The captured photo and certificate photo can be taken separately or at the same time (which can be set in Parameter Settings). If there is a camera (High-Speed Portable HD Doc Scanner) connected to the server, you can click Capture to take the visitors' photos. The browser may block the camera to access, please click  in the IP address bar to select the camera and change the setting to allow access to this page.

Table 10- 3 Description of New Parameters for Positions

10.3.1.3 Batch

Batch option will help you to do multiple check-in and check-out at a time.

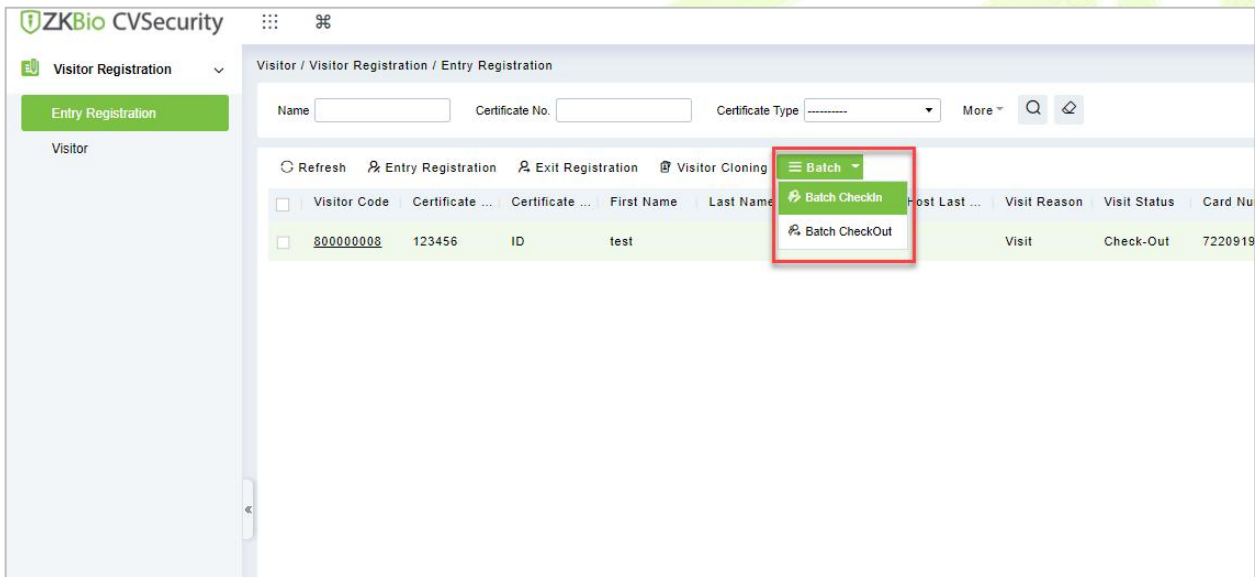

Figure 10- 6 Batch Interface

- **Batch Check-in**

Batch Check-in option will help you to do multiple check-in at a time. For that you need to create a reservation for the visitors. Then you can be able to see details in the **Batch Checkin** option for multiple check-ins at a time.

Operating Steps:

Step 1: In the **Visitor** module, select **Visitor Reservation > Visitor Reservation**. In the reservation interface, click **New** to complete the reservation registration.

Step 1: In the **Visitor** module, select **Visitor Registration > Entry Registration**.

Step 2: In the Entry Registration interface, select the visitor to do the check-ins and click **Batch > Batch checkin** to do multiple check-in of visitors at a time.

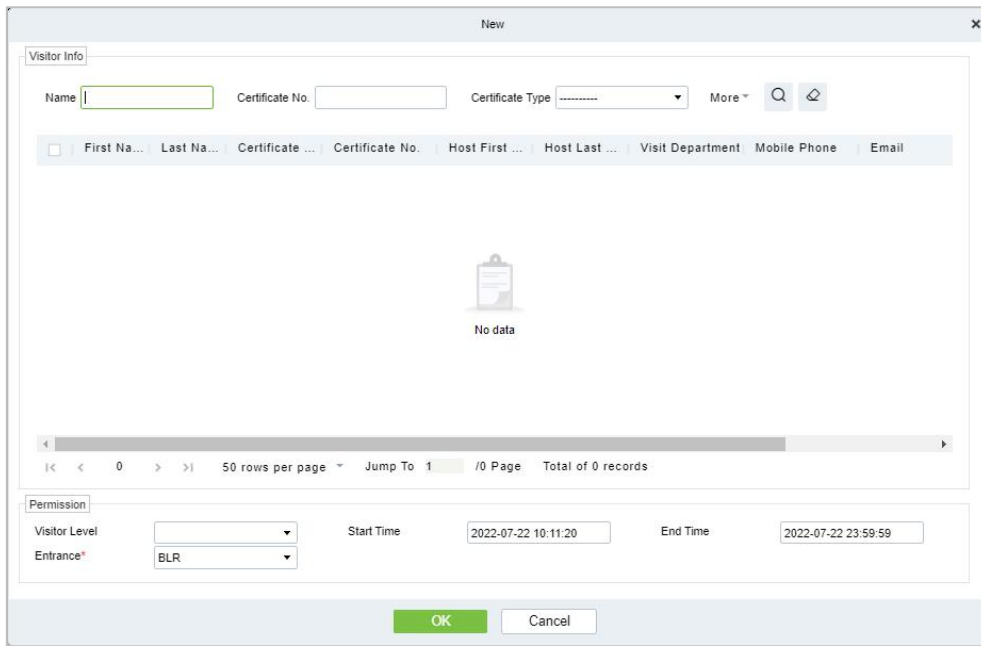

Figure 10- 7 Batch Check in interface

Step 3: Click **OK** to check in the selected visitors.

● **Batch Check Out**

Batch check in option will help you to do multiple check out of visitors at a time.

Operating Steps:

Step 1: In the **Visitor** module, select **Visitor Registration > Entry Registration**.

Step 2: In the Entry Registration interface, select the visitor to do the checkouts and click **Batch > Batch checkout** to do multiple checkouts of visitors at a time.

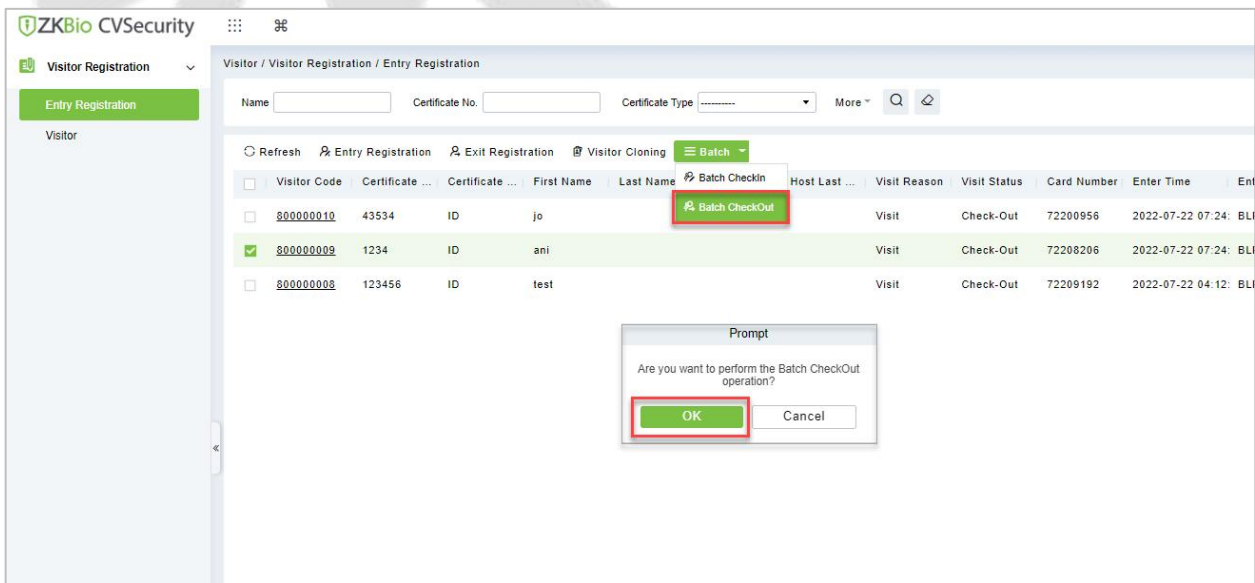

Figure 10- 8 Batch Check out interface

Step 3: Click **OK** to check-out the selected visitors.

10.3.2 Visitor

Visitor interface provides the complete details about the registered visitors such as Visitor Code, First Name, Last Name, Certificate Type, Certificate No., Company etc. You can delete, disable or enable and export the selected visitor.

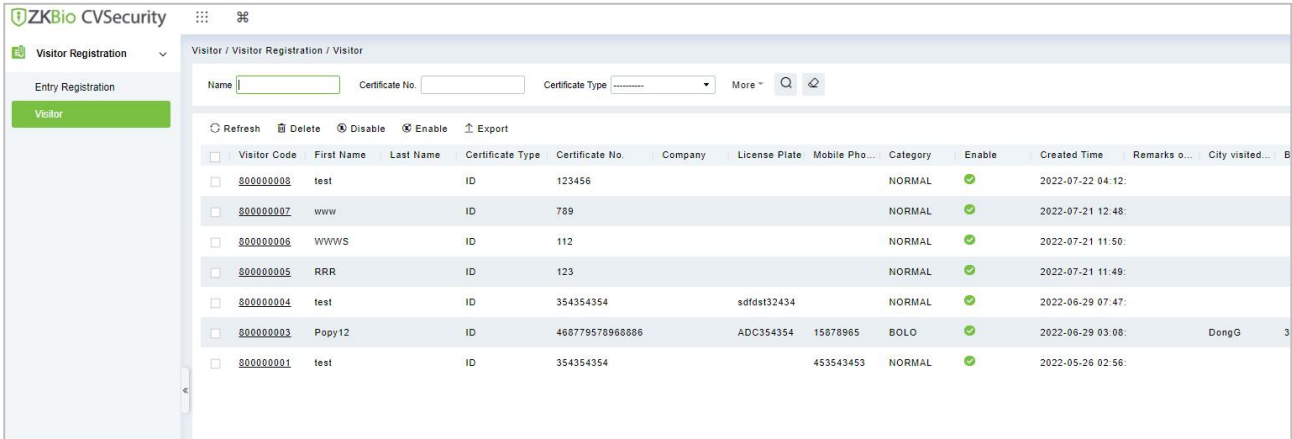

Figure 10- 9 Visitor Interface

10.3.2.1 Deleting a Visitor (Delete)

In **Visitor** module click **Visitor Registration > Visitor**, select a visitor, and click **Delete**.

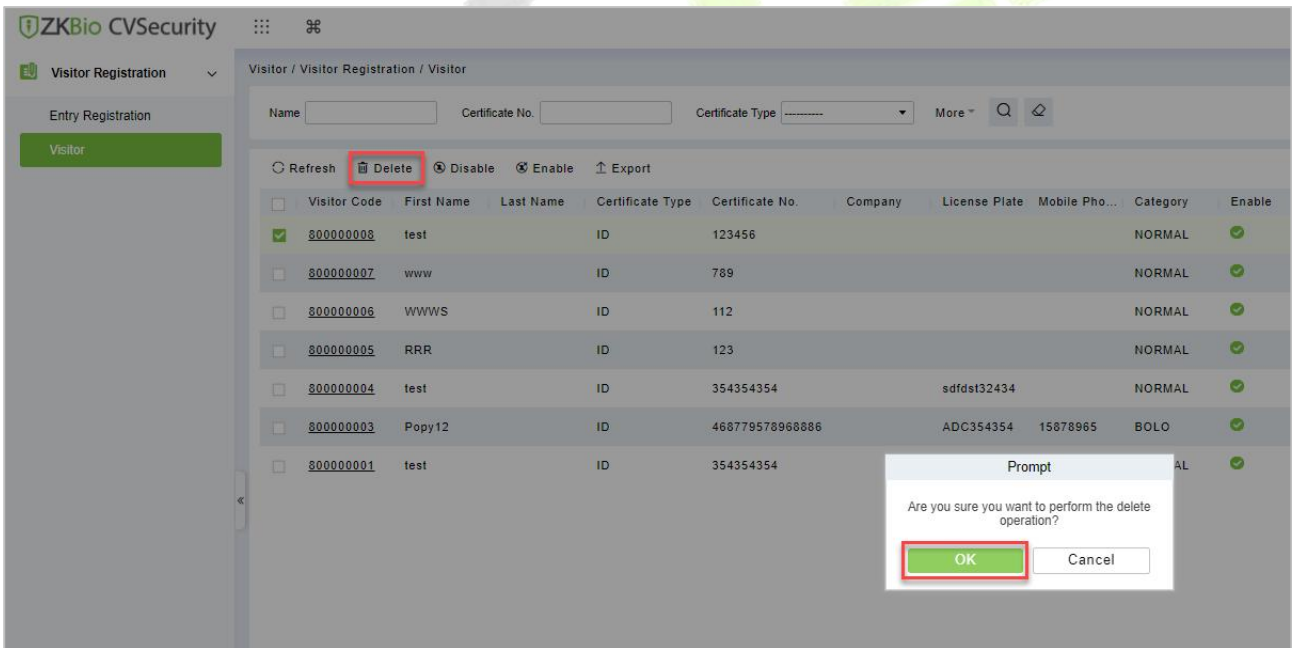

Figure 10- 10 Deleting Visitor

Click **OK** to delete the selected visitor.

10.3.2.2 Disabling a Visitor (Disable)

In **Visitor** module Click **Visitor Registration** > **Visitor**, select a visitor, and click **Disable**.

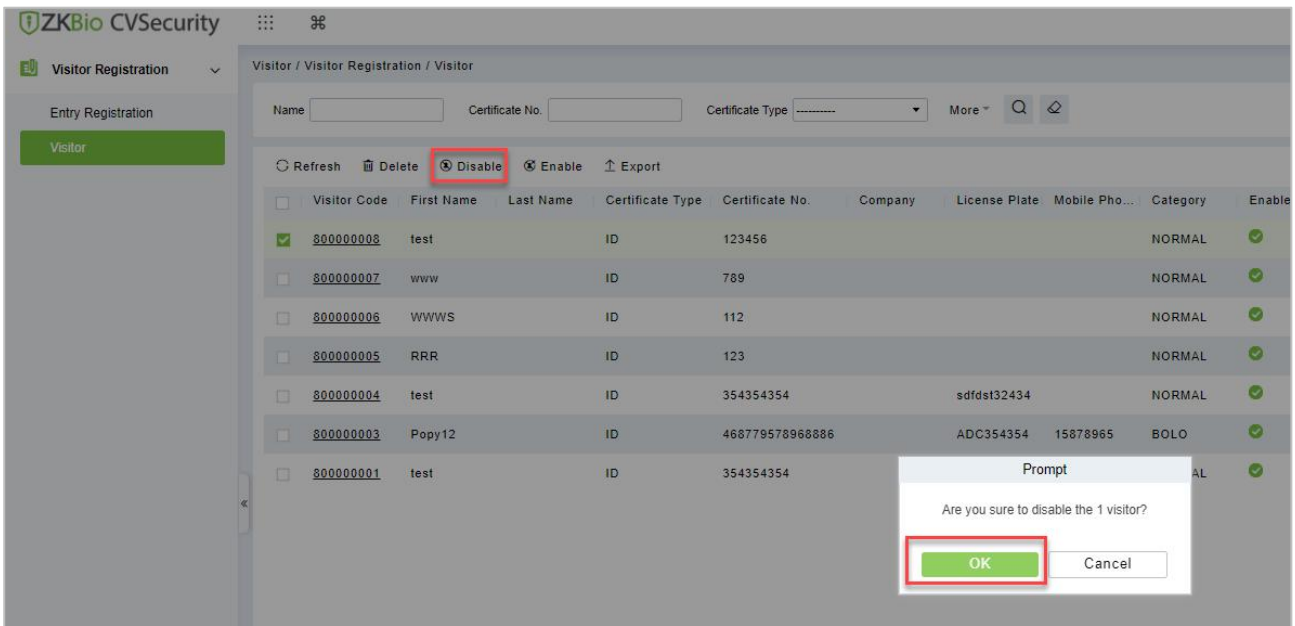



Figure 10- 11 Disabling Visitor

Click **OK** to block the visitor. The enable entry for the corresponding selected visitor will show  indicates the visitor is blocked.

10.3.2.3 Enabling a Visitor (Enable)

In **Visitor** module Click **Visitor Registration** > **Visitor**, select a blocked visitor, and click **Enable**.

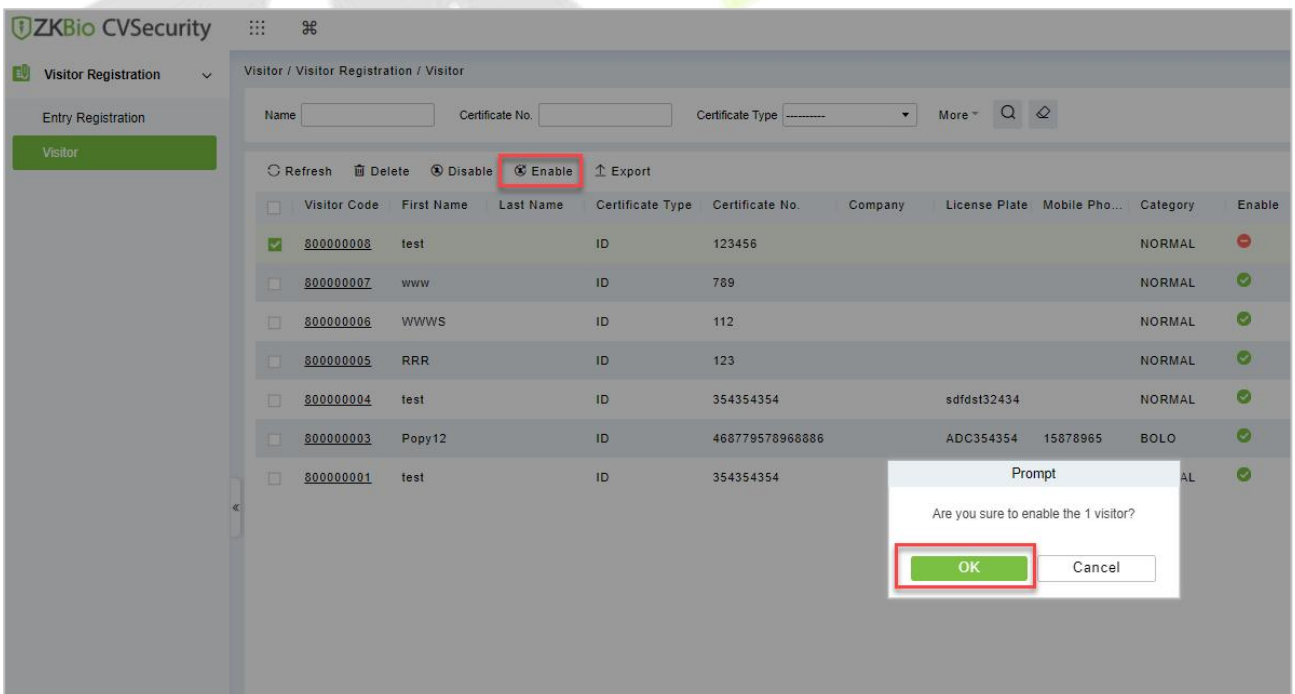



Figure 10- 12 Enabling Visitor

Click **OK** to enable the visitor. The enable entry for the corresponding selected visitor will show  indicates the visitor is enabled.

10.3.2.4 Export

You can export visitor details into an Excel, PDF, or CSV file. See the following figure10-20.

Operating Steps:

Step 1: In **Visitor** module click **Visitor Registration > Visitor > Export** to export the visitor records to Excel sheet or PDF or CSV. Enter the User password in the prompt.

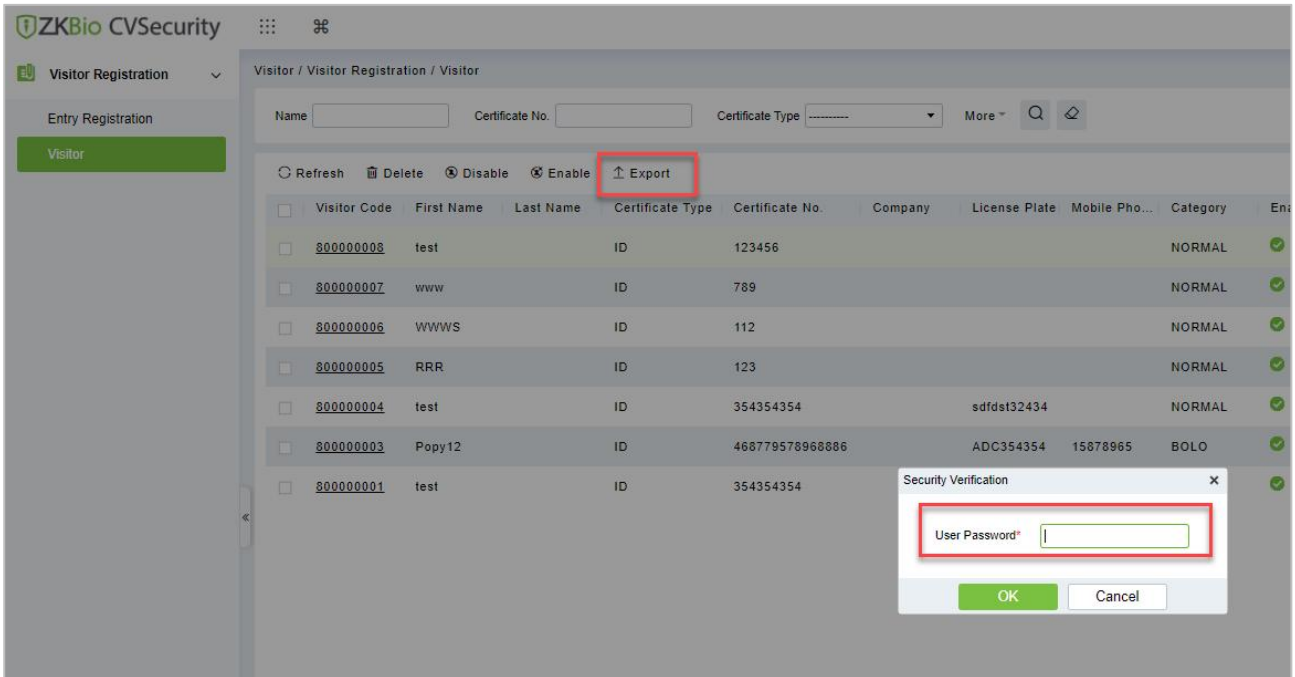

Figure 10- 13 Export Interface

Step 2: Select the file format and click **OK**.

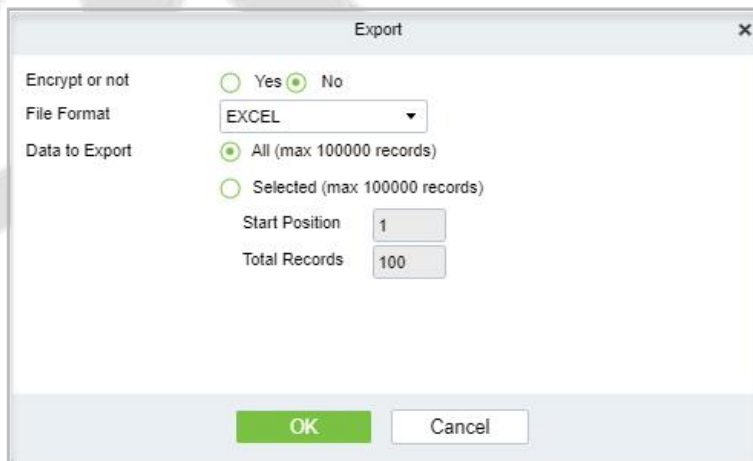

Figure 10- 14 Export Interface

10.4 Visitor Reservation

10.4.1 Visitor Reservation

Visitor Reservation helps you to do reservations before the visitor’s visit.

10.4.1.1 Adding a Visitor Reservation (New)

Creating new Reservations for Visitors.

Operating Steps:

Step 1: In the **Visitor** module, select **Visitor Reservation > Visitor Reservation**.

Step 2: In the reservation interface, click **New** to complete the reservation registration before the visitor’s visit.

Figure 10- 15 Reservation Interface

Parameter	Description
Host/Visited	Select the visited personnel. Click the input box to filter the query according to the input characters or click the query button to pop up the list of the visited personnel to select the visited personnel.
Visit Department	Select the department the visitor will visit.
Visit Reason	Select the visit reason. You can also input a new reason, and the reason will be added in the Visit Reason list in the Visit Reason of Basic Management .
Certificate Type	Passport, Driving License, ID Card, and Others are available to choose from the drop-down list. If the ID Scan OCR function is activated, visitor information will display automatically after clicking  icon.
Certificate No.	The numbers and letters are legal; the max length is 20.
First Name	Enter the first name of the visitor.
Start and End Time	Enter the start and end times of the visit.

Parameter	Description
Personnel Details	Enter the personnel details.
Portrait	The captured photo and certificate photo can be taken separately or at the same time (which can be set in Parameter Settings). If there is a camera (High-Speed Portable HD Doc Scanner) connected to the server, you can click Capture to take the visitors' photos. The browser may block the camera to access, please click  in the IP address bar to select the camera and change the setting to allow access to this page.

Table 10- 4 Description of Parameters of Adding a Visitor Reservation

After the reservation visitors can complete the visit registration using Entry Registration option to know more about the registration process.

10.4.1.2 Deleting a Visitor Reservation (Delete)

In the **Visitor** module, select **Visitor Reservation > Visitor Reservation** select a visitor reservation and click **Delete**.

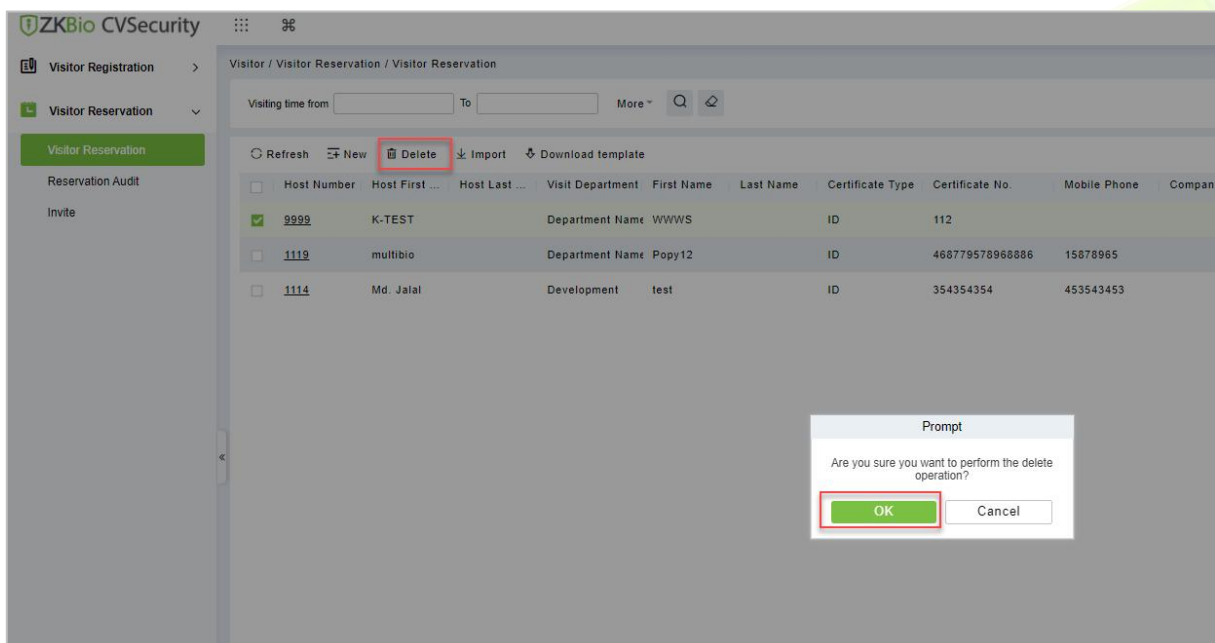

Figure 10- 16 Deleting Visitor Reservation

Click **OK** to delete the selected visitor reservation.

10.4.1.3 Import

You can import visitor reservation details into the software as in Excel format. See the following Figure10-17.

Operating Steps:

Step 1: In the **Visitor** module, select **Visitor Reservation > Visitor Reservation**, select a visitor reservation and click **Import**.

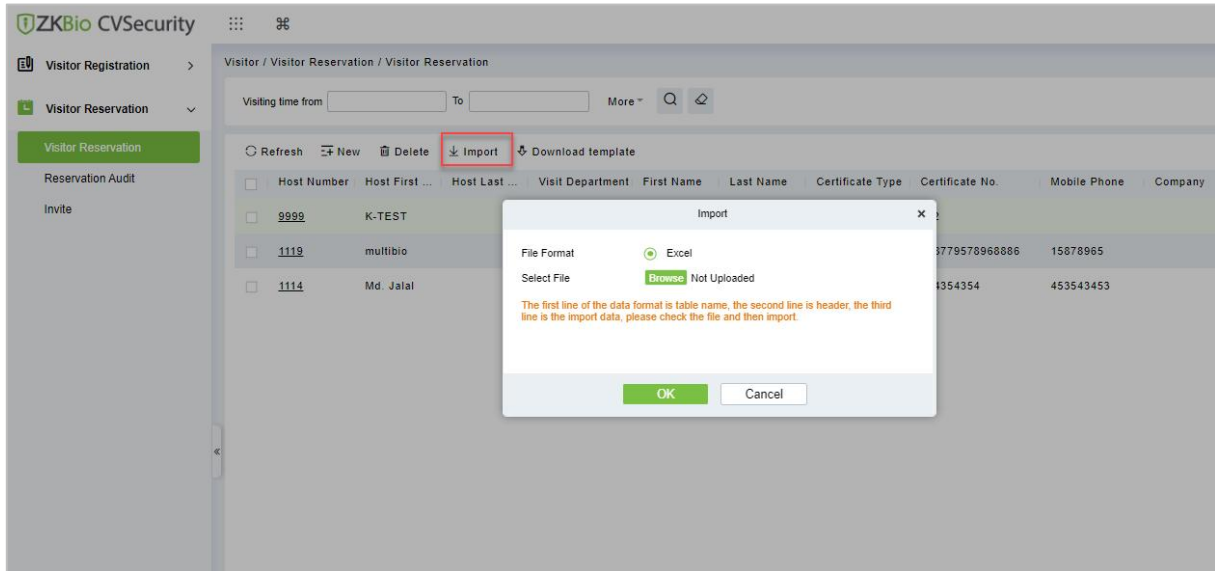

Figure 10- 17 Import Visitor Reservation

Step 2: Click the **Browse** button to import the visitor reservation template data (You can download the template from the software by clicking **Download Template**) into the system, as shown in Figure 10-17.

Step 3: Click **OK**, and the interface displays the result of importing and adding visitor reservations.

Step 5: Click **Close** to complete the import and addition of visitor reservations.

10.4.1.4 Download Template

You can download template visitor reservation details into the software as in Excel format.

Operating Steps:

Step 1: In the **Visitor** module, select **Visitor Reservation > Visitor Reservation** select a visitor reservation and click **Download Template**.

Step 2: Click **OK**, and the interface displays the result of importing and adding visitor reservations.

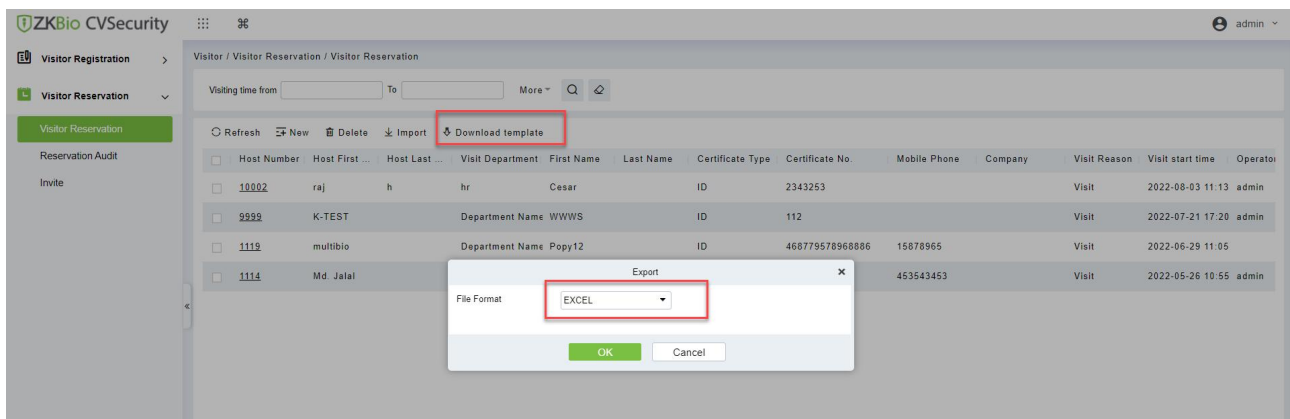

Figure 10- 18 Import Visitor Reservation

10.4.2 Reservation Audit

Allow the administrator to review and block the employee’s self-reservation visitors.

10.4.2.1 Review

Allow the administrator to review the employee’s self-reservation visitors.

Operating Steps:

Step 1: In the **Visitor** module, select **Visitor Reservation > Reservation Audit**.

Step 2: In the **Reservation** interface, select the visitor to be reviewed and click **Review** to review the visitor.

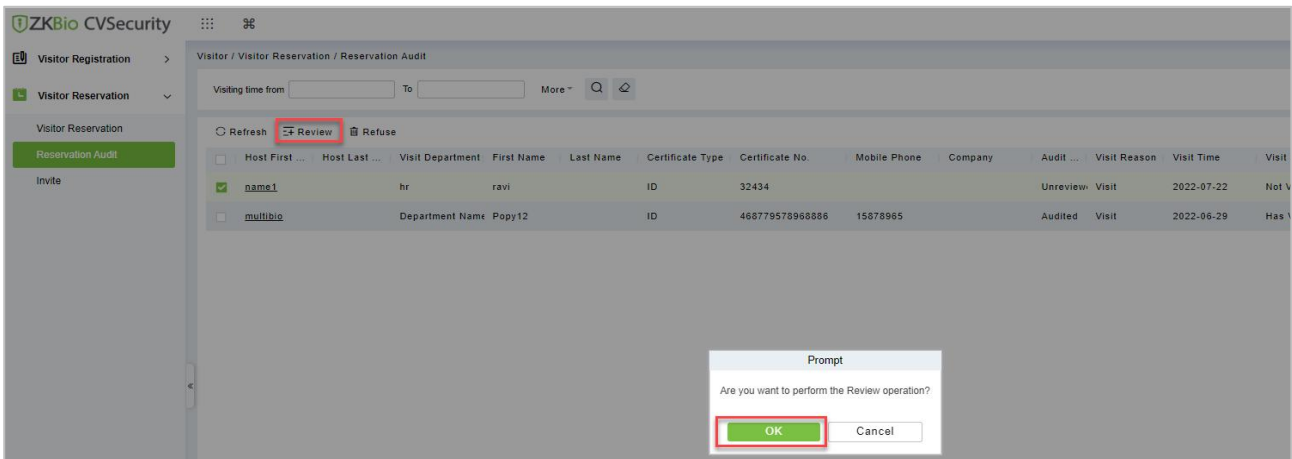

Figure 10- 19 Review Visitor Reservation

Step 3: Click **OK** to perform the review operation.

10.4.2.2 Refuse

Allow the administrator to block the employee’s self-reservation visitors.

Operating Steps:

Step 1: In the **Visitor** module, select **Visitor Reservation > Reservation Audit**.

Step 2: In the **Reservation** interface, select the visitor to be reviewed and click **Refuse** to block the visitor.

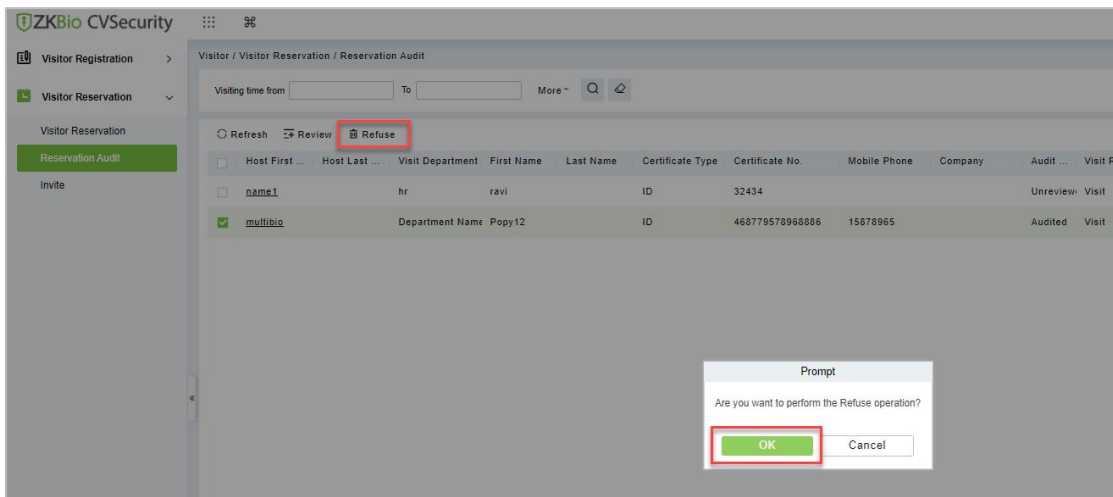

Figure 10- 20 Refuse Visitor Reservation

Step 3: Click **OK** to perform the refuse operation.

10.4.3 Invite

10.4.3.1 Sending Invitations (New)

You can send invitations to the needed visitors by using this option.

Operating Steps:

Step 1: In the **Visitor** module, select **Visitor Reservation > Invite**.

Step 2: In the **Invite** interface, click **New** to send the invitation to the visitors and the details as shown in Figure 10-21.

Step 3: Click **OK** to send the invitation.

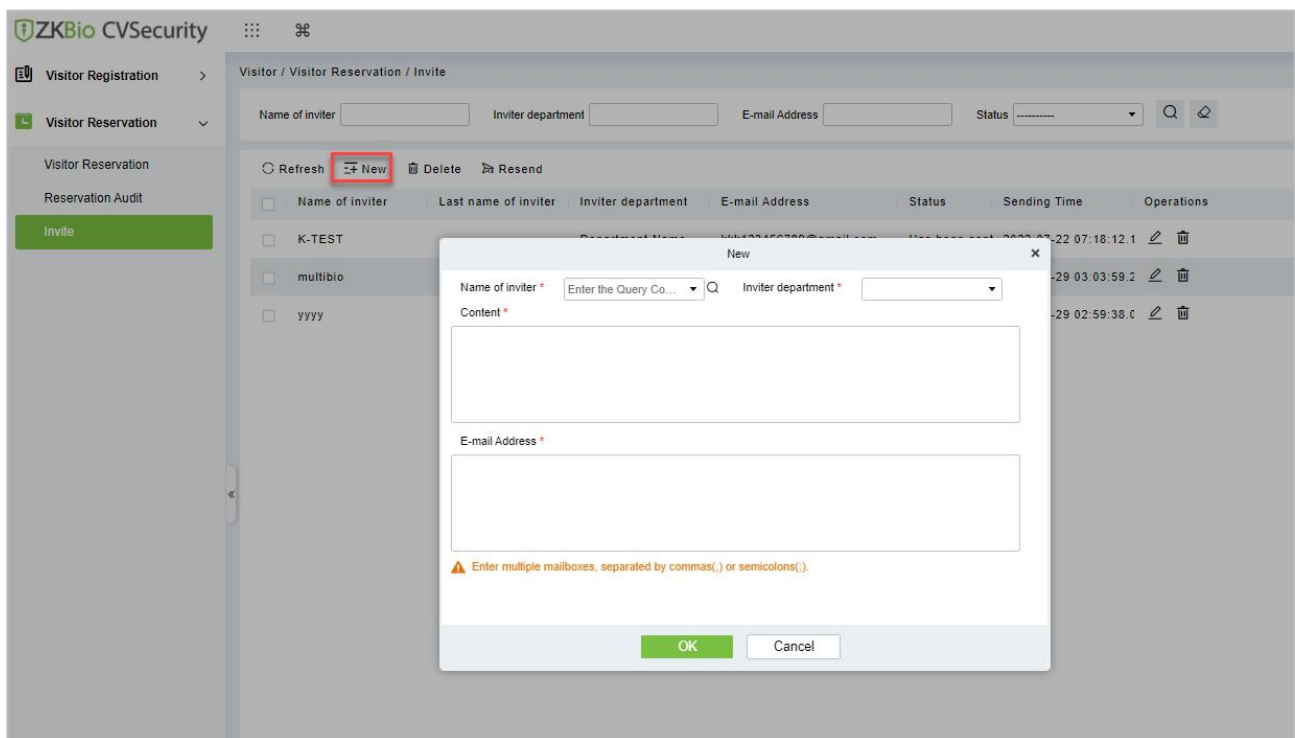

Figure 10- 21 Invite Interface

Parameter	Description
Name of the Inviter	Select the visited personnel. Click the input box to filter the query according to the input characters or click the query button to pop up the list of the visited personnel to select the visited personnel.
Inviter Department	Select the department of the inviter.
Content	Enter the content or reason of the invitation.
Email Address	Enter the Email address.

Table 10- 5 Description of Parameters of Invite Visitors

10.4.3.2 Delete Invitations

To delete the visitor invitations.

Operating Steps:

Step 1: In **Visitor** module click **Visitor Reservation > Invite**.

Step 2: In the invite interface select the invitation to be deleted and click **Delete**.

Step 3: Click **OK** to delete the invitation.

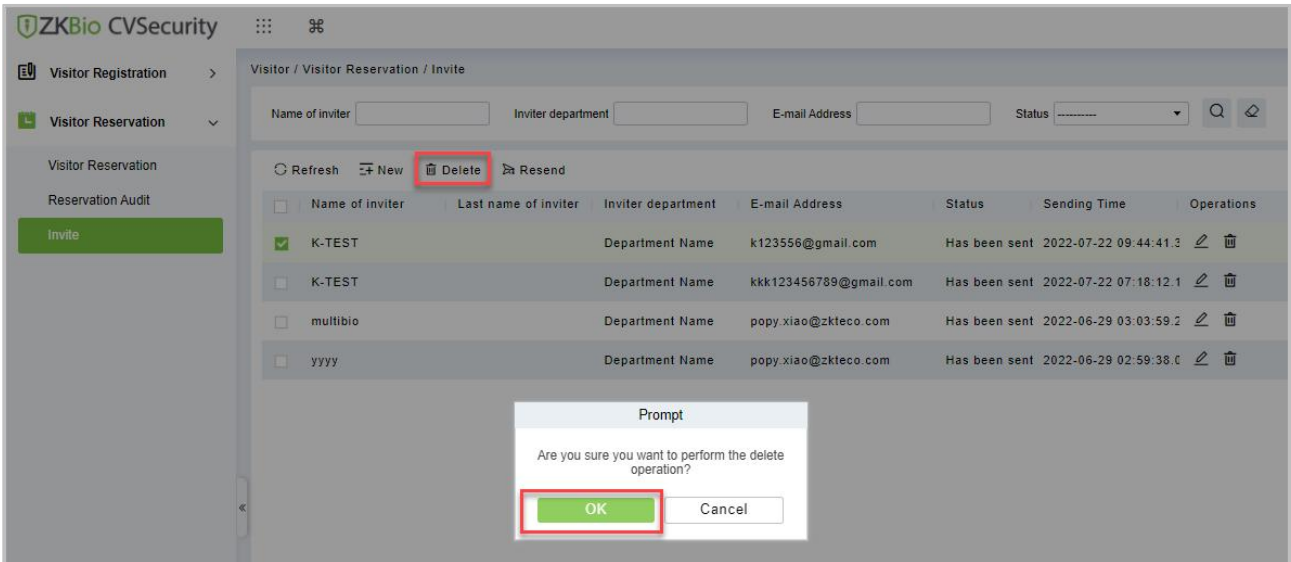

Figure 10- 22 Delete Invitations

10.4.3.3 Resend Invitation

To Resend the visitor invitations.

Operating Steps:

Step 1: In **Visitor** module click **Visitor Reservation > Invite**,

Step 2: In the invite interface select the invitation to be resend and click **Resend**.

Step 3: Click **OK** to resend the invitation.

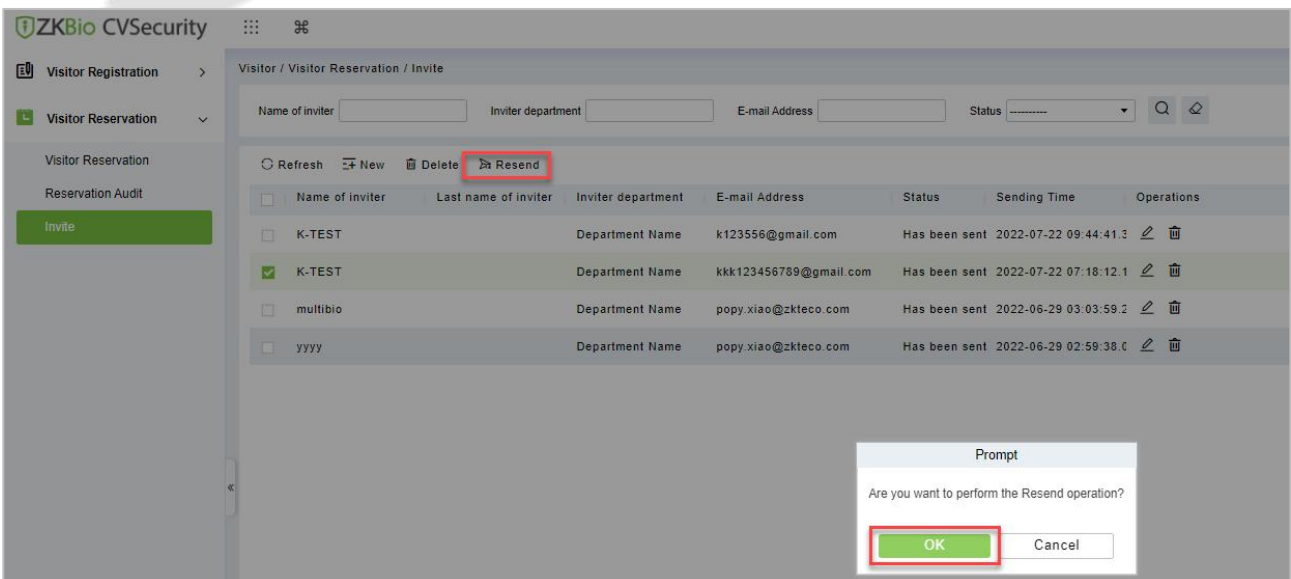

Figure 10- 23 Resend Invitations

10.4.4 Respondent Self-Approval

Optimize the visitor process, after sending the visitor invitation email, ZKBio CVSecurity will send an audit email to the host. The host can complete the operation of "Review or Reject" by clicking on the audit link of the email, then quickly complete the review.

Set the Outgoing Mail Server Settings:

Step 1: In **System Management** module, click **Email Management > Outgoing Mail Server Settings**:

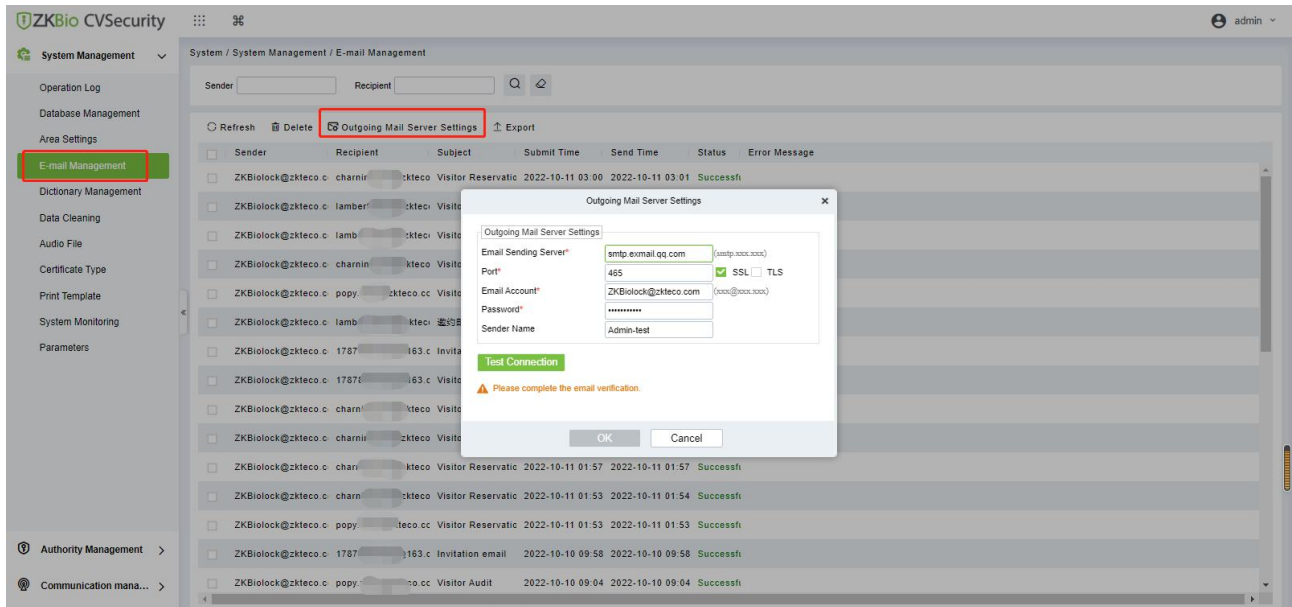

Figure 10- 24 Outgoing Mail Server Settings

Step 2: Set the Outgoing Mail Server Settings as Table 2.5-1.

Parameter	How to set up
Email server address/port	You can customize the email server address and port. The email products that provide the SMTP server can be used, such as NetEase 163 email, Tencent QQ email, and Foxmail email. The specific address and port configurations must be obtained from the corresponding provider.
Email username and password	Enter the user's name and password for the mailbox.
Name of sender	Sets the name of the sender on the received message.

Table 10- 6 Outgoing Mail Server Settings

Step 3: After setting, click **Test Connection** to receive the email, indicating that the test has passed.

Step 4: Click **OK** to finish setting email parameters.

Note: The domain name of E-mail address and E-mail sending server must be identical. For example, the Email address is test@gmail.com, and the E-mail sending server must be smtp.gmail.com.

Set Visitor Parameters:

Step 1: In **Visitor** module, Click **Basic Management > Parameters**.

Step 2: Select **No** for the **Enable automatic review of guest appointments**, so that the visitors' reservations need to be approved.

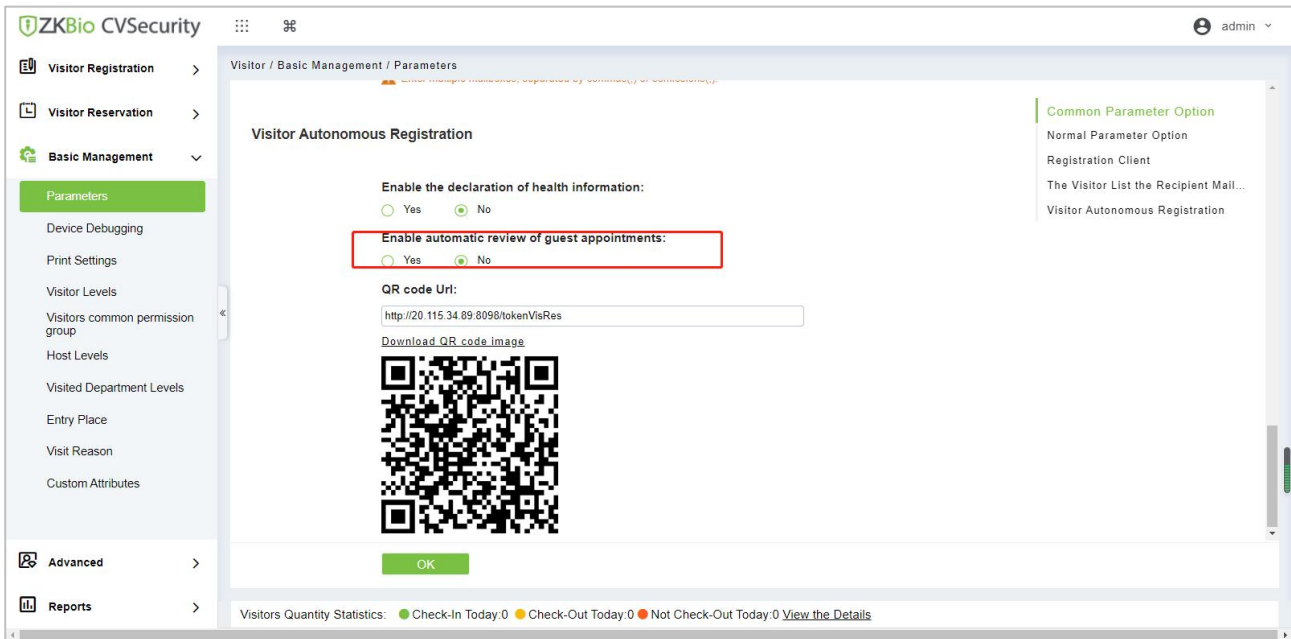

Figure 10- 25 Enable automatic review of guest appointments

Set the Host Levels:

In the **Visitor** module, click **Visitor > Host Levels> +New**, select the corresponding personnel, click **>**, set the host Level for the corresponding personnel.

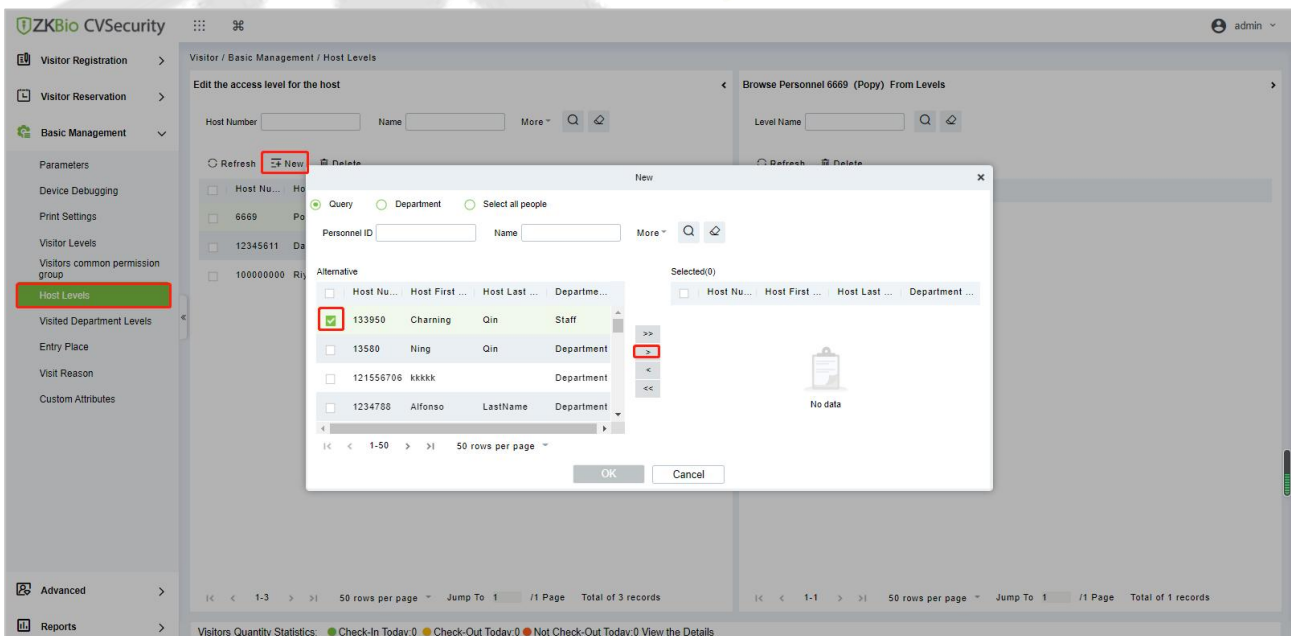

Figure 10- 26 Adding Host Levels 1

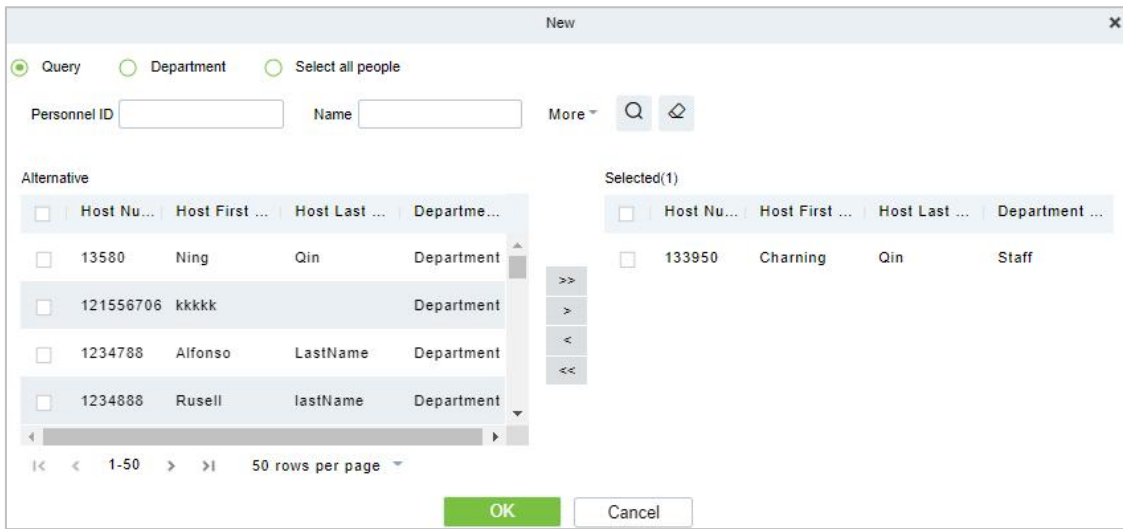

Figure 10- 27 Adding Host Levels 2

Set the Linkage:

Step 1: Add an alert template.

Click **Visitor > Advanced > Alert Template > +New**, and fill in the template information.

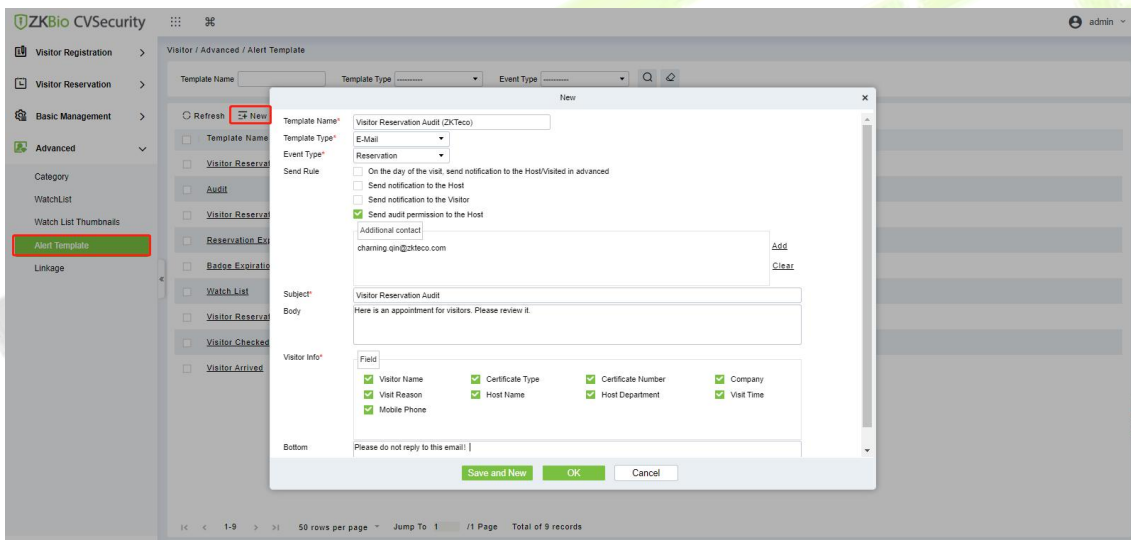

Figure 10- 28 Add an Alert Template.

Parameter	How to set up
Template Type	E-Mail
Event Type	Reservation
Send Rule	Select Send audit permission to the Host Fill in the Additional Contact with the host email.
Subject	Fill in the subject and the body content.
Visitor Info	Select the visitor content to be audited.

Table 10- 7 Add an Alert Template.

Step 2: Add a linkage.

Click **Visitor > Advanced > Linkage > +New**, and here we select the E-mail template *Visitor Reservation Audit(ZKTeco)* added in Step 1.

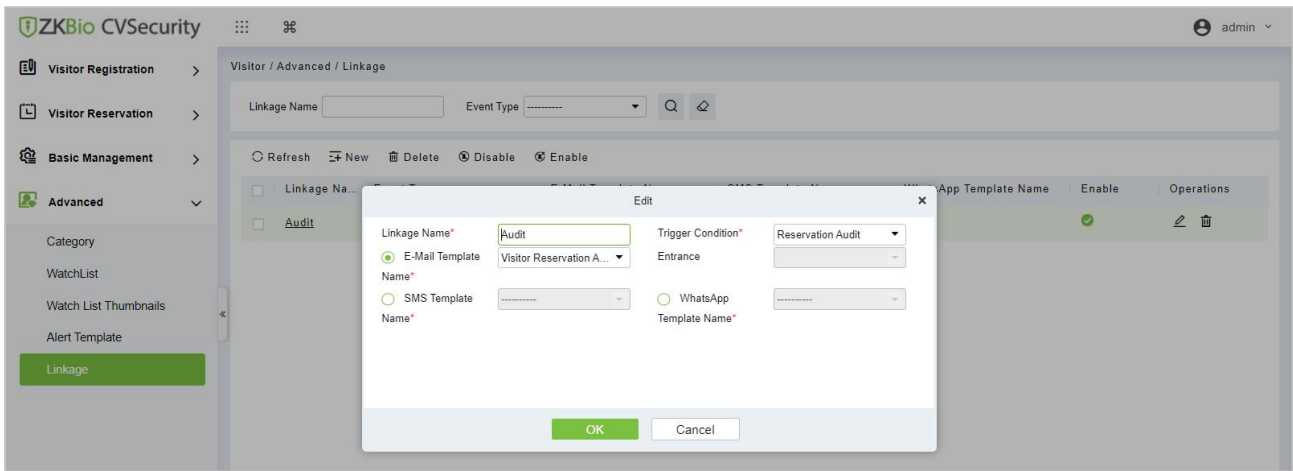

Figure 10- 29 Add a Linkage

Send an invitation E-mail:

Step 1: Click **Visitor > Visitor Reservation > Invite > +New**, fill in the correct information and save.

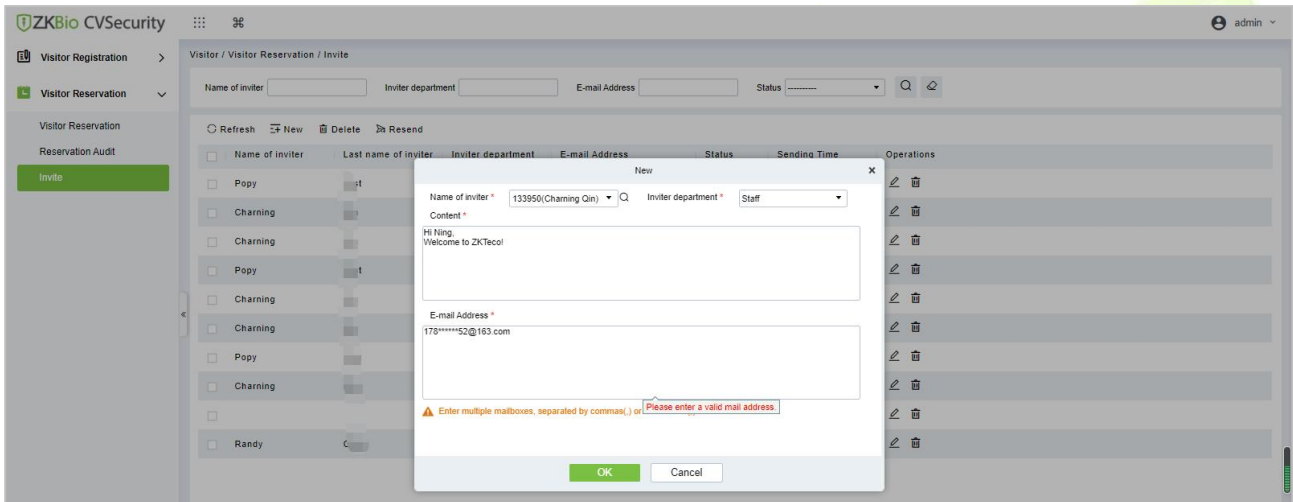

Figure 10- 30 Send an invitation E-mail 1

Step 2: We can view the record of this invitation email. If the status of the email is Has been sent, the email is sent successfully.

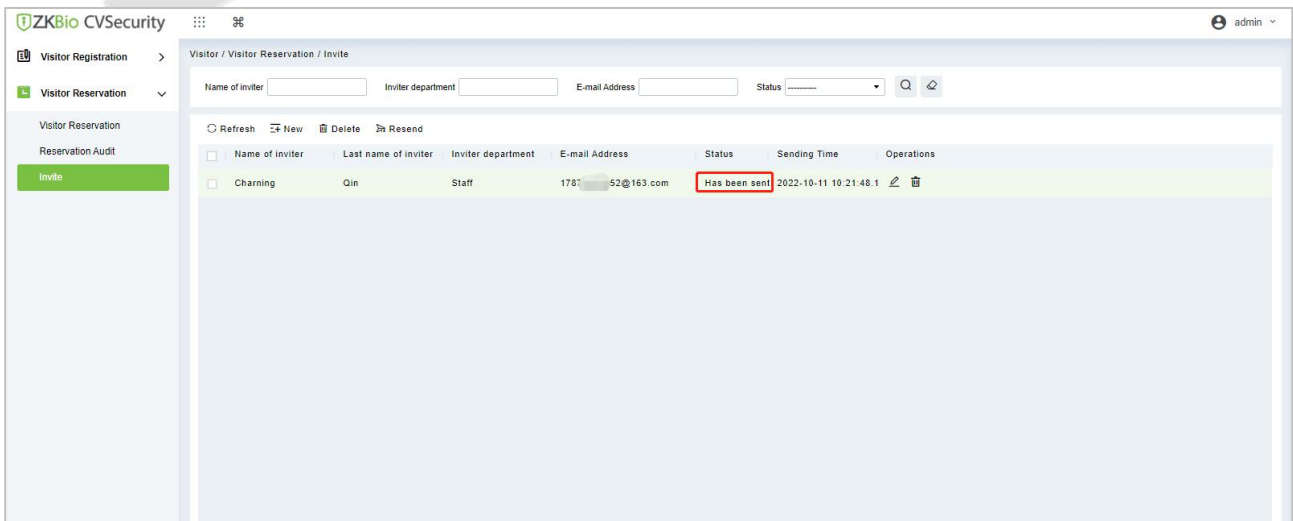

Figure 10- 31 Send an invitation E-mail 2

Visitor Registration:

Visitors who have received the invitation will receive an email as follows, then the visitor click **Click here** to register as a visitor.



Figure 10- 32 Invitation E-mail

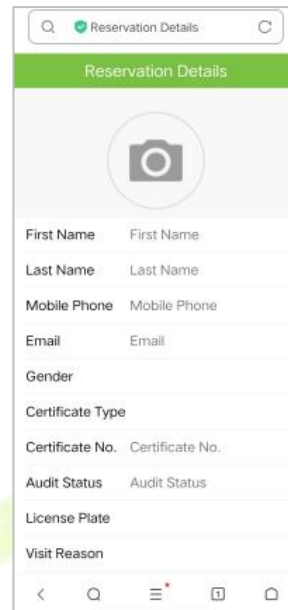

Figure 10- 33 Visitor Registration

Visitor Reservation Audit:

When a visitor submits registration information, host will receive a review email as shown below:

Click **Review** if you agree to make an appointment;

Click **Refuse** if you refuse the appointment.

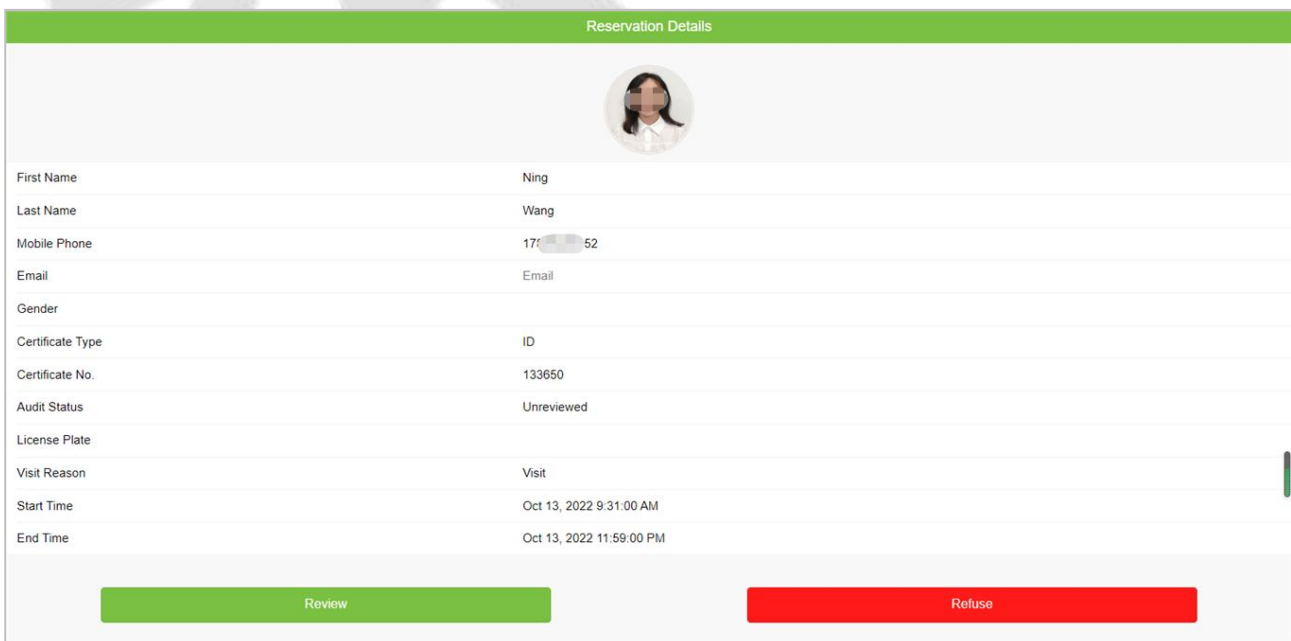

Figure 10- 34 Visitor Reservation Audit

10.5 Basic Management

10.5.1 Parameters

In **Visitor** module Click **Basic Management** > **Parameter** to set the parameters.

Common Parameter Option

Carrying Goods Capture
 Carrying Goods Capture Photo

Exit Registration
 Open the Visitor Exit Function
 Automatic Sign Out [Set Automatic Sign Out Place](#)
▲ Visitors exited from the set reader, will be automatically checked out.
 Sign Out Expired Visitors
▲ The invalid Visitors that having not been checked out manually, will automatically be checked out/performed every (minutes).

Sign Up
 Enable automatic sign-in function [Set automatic sign-in location immediately](#)
▲ Swipe the QR code (face) from the set reader to sign in, and sign in will be performed automatically.

Permission
 Without Permission
 Permission is Required
 Whether to Issue Card Password is Required
 Biological Template Registration is Required Scan Code is Required

Select the Required Field
 Host/Visited Visit Department

Visitor Vehicle Authorization Mode
 Temporary Vehicle Allowlist

Normal Parameter Option

Capture
 Capture the Portrait and Certificate Photo Together
 Capture the Portrait and Certificate Photo Separately

Visitor History Information
 Open the Pop-Up Box to Display Visitor History Information
 Backfill Visitor Bio Template Backfill Visitor Photo

Copy ID Number as Card Number Automatically
 Copy ID Number as Card Number

WatchList Option
 On Entry Prompt if Name Matche
Match Type
 On Entry Match by Certificate
 On Entry Match by Country/Region
 On Entry Match by Company

Maximum visitor check
 Open single-day maximum visitor visits monitoring
Maximum number of visits
 Open single-day single-person maximum visitor visits monitoring
Maximum number of visits

Registration Client

Device Driver
Certificate Recognition Driver Installation Status: Detected Certificate Recognition Driver is not installed

Certificate Recognition
 OCR IDReader

Registration Code:

Download OCR V1.0 Driver Download OCR V2.0 Driver

Certificate No. Automatic Backfill Type
 Document No. Personal No.

The Visitor List the Recipient Mailbox

Send the visitors information during the day by email. Sending Time:
 :
Example: 123@xxx.com, 456@xxx.com
▲ Enter multiple mailboxes, separated by comma(,) or semicolons(,).

Visitor Autonomous Registration

Enable the declaration of health information:
 Yes No

Enable automatic review of guest appointments:
 Yes No

QR code Url:

[Download QR code image](#)



Visitors Quantity Statistics: ● Check-In Today:3 ● Check-Out Today:3 ● Not Check-Out Today:0 [View the Details](#)

Figure 10- 35 Parameter

Common Parameter Option:

Carrying Goods Capture: Enable it to take the photo to the goods carried by the visitor.

Exit Registration: Enable or disable the auto sign-off function. Auto sign-out means a visitor leaves by directly punching a card or using his/her fingerprint at the preset auto sign-out place, without performing the Exit Registration operation in the software. Setting automatic sign-out place means specifying some readers as the auto sign-out place. Click **Set Automatic Sign Out Place**. Then click **OK** to finish.

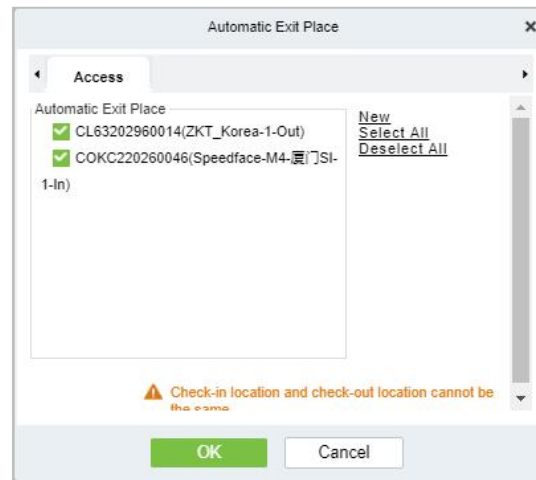

Figure 10- 36 Automatic Exit Place

Sign Out Expired Visitors: Expired visitors who have not been manually signed out will be automatically signed out after a specified interval.

Permission:

Whether to Issue Card: Whether to issue card for the visitor.

Fingerprint Registration is Required: Whether to register the fingerprint for the visitor.

Password is required: If selected, it will make password mandatory.

Scan Code is Required: If selected, it will code scan mandatory

Select the Required Field: You can set whether the Host (Personnel) and visited departments would be required in the registration page and the reservation page.

Visitor Vehicle Authorization Mode: You can set this option as per the reliability of the vehicle. If you want to make all vehicle details to be noted, then select Temporary Vehicle. If only one or some vehicle enters on a regular basis, then you can keep them in whitelist.

Normal Parameter Option:

Capture: Whether to capture the portrait and certificate photo together.

Visitor History Information: You can select the display parameters of the visitor history. Selecting the Open the Pop-Up Box to Display Visitor History Information check box displays the visitor information with photo and fingerprint of the visitor (These two will be auto-selected).

Copy ID Number as Card Number Automatically: Enable this if you want to use the same ID number as the Card number.

WatchList Option:

Select the Watchlist parameter as given below:

- On Entry Prompt if the Name matches. It can be first name only or Last name First name.
- On Entry Match by the certificate provided by the visitor.
- On Entry Match by the Country/Region of the visitor.
- On Entry Match by the Company of the visitor.

Maximum visitor check: You can define the parameters to limit the number of visitors and the number of visit times.

Note: When the number of visitors reaches the default upper limit set on the day, a prompt will pop up when entering the registration page:

Registration Client:

Step 1: If there is no driver installed in the system, the **Download Driver** link is displayed. Click the link to download and install the driver.

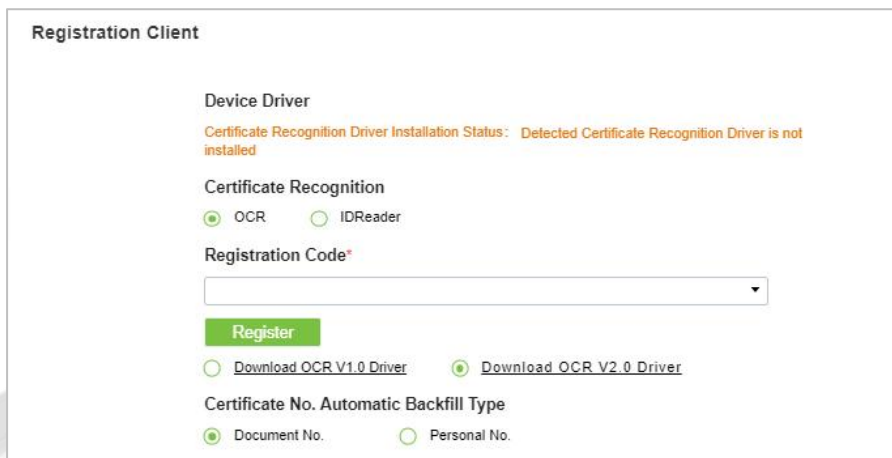

Figure 10- 37 Registration Client

Step 2: Enter the corresponding registration code and click **Register**.

Note: Click **System > Authority Management > Client Register** to view the registration code.

The Visitor List the Recipient Mailbox:

Configure the recipient's mailbox and the time for system to send the list of visitors today.



Figure 10- 38 Visitor List the Recipient Mailbox

Visitor Autonomous Registration:

Enable or disable the declaration of visitor's health information and automatic view of guest appointments.

10.5.2 Device Debugging

Device Debugging option will provide information about Entry Place, Print installation, Device Driver installation, and USB Camera.

In **Visitor** module Click **Basic Management > Device Debugging** to know about the current location details (including IP address), Printer-driver installation information, device driver installation, calibrate the scanners, and USB camera information.

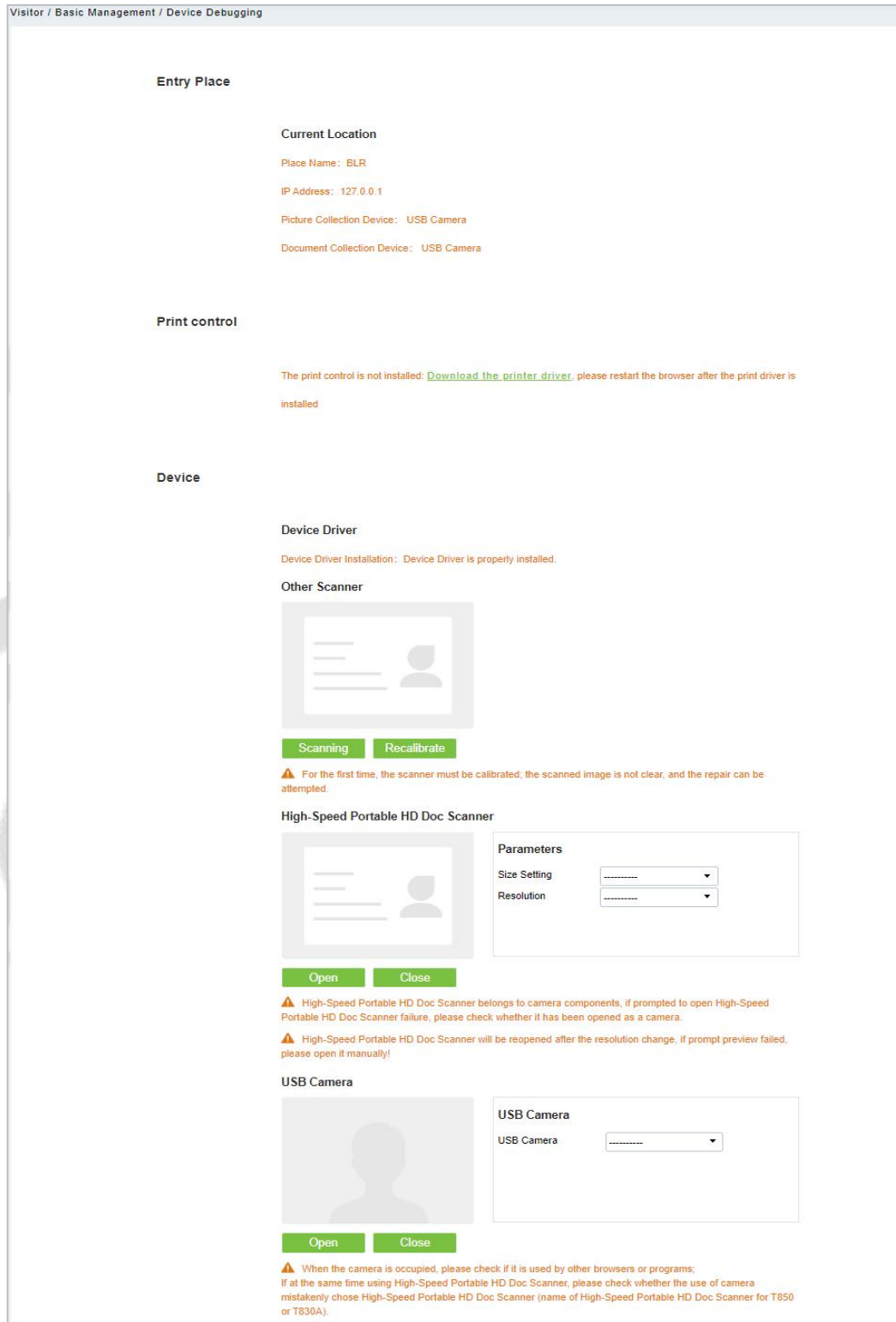

Figure 10- 39 Device Debugging Interface

Parameter	Description
Entry Place	Displays the information of the current entry place, such as the name of the entry place, IP, Mode of picture/document collection.
Print Control	It shows the Printer-driver installation information
Device	Display device driver installation, you can debug, calibrate the scanner. Set the High-Speed Portable HD Doc Scanner parameters, and information of USB camera. (IE browser does not display USB device debugging).

Table 10- 8 Description of Parameters of Device Debugging

10.5.3 Print Settings

In **Visitor** module Click **Basic Management** > **Print Setting** to go to the printer settings.

Global Settings (Receipt Printer):

Select **Receipt Printer** to set the global setting of the printer.

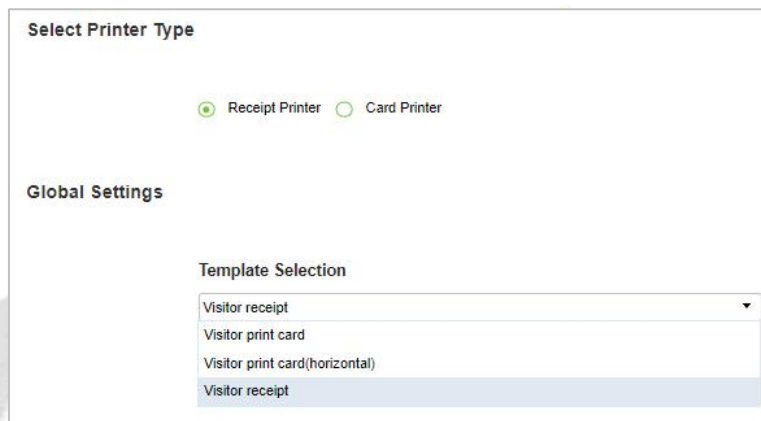

Figure 10- 40 Global Settings of Printer

Parameter	Description
Template Selection	Select a template to print the template, if the template does not meet the print content, you can add or edit the template (the default template cannot be edited, deleted). Available Templates are Visitor Receipt, Visitor Print Card and Visitor Print Card (Horizontal).

Table 10- 9 Description of Parameters of Printer Setting

Local Settings (Receipt Printer):

You can set the options for the printer, the type of paper to be printed, or the custom paper size, and view the effect by clicking Print Preview / Direct Print. At last, you can save the current setting for the printout of the visitor badge.

Local Settings

Print control

The print control is not installed: [Download the printer driver](#), please restart the browser after the print driver is installed

Use Printer

Select Paper Type

Paper Type

⚠ The paper type can only use the system default types. Please check in the print preview to see if it will work.

Custom Paper Size

Custom Paper Width

mm

Custom Paper Height

mm

Custom Paper Width, Highly Adaptive

Custom Paper Width

mm

⚠ The setting width of the paper is greater than the actual width of the paper, will affect the print effect.

Figure 10- 41 Local Settings of Printer

Parameter	Description
Use Printer	Select the printers from the available list of printers.
Paper Type	Select the Paper Type
Custom Paper Size	You can customize the paper size like paper height and width.

Table 10- 10 Description of Parameters of Local Settings of Printer

Card Printing:

In the parameter setting interface, you can set the parameters of card. Initially, define the template (refer to personnel card printing), and then set the card printing function. If the automatic card printing is selected, printer connection is required. After the visitor registration is completed, user can print the card directly.

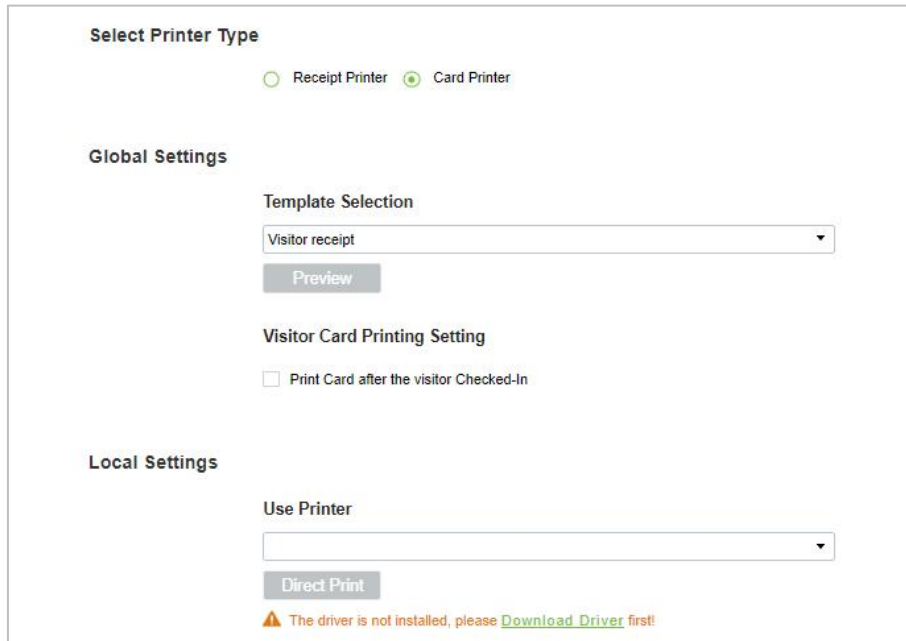

Figure 10- 42 Printer Setting of Card Printer

Parameter	Description
Template Selection	Select a template to print the template, if the template does not meet the print content, you can add or edit the template (the default template cannot be edited, deleted). Available Templates are Visitor Receipt, Visitor Print Card and Visitor Print Card (Horizontal).
Visitor Card Printing Setting	Select the visitor card printing settings (like after visitor check in)
Use Printer	Select the printer from the available list of printers.

Table 10- 11 Description of Parameters of Printer Setting of Card Printer

10.5.4 Visitor Levels

The visitor can be allocated Access or Elevator levels within registration after the visitor level has been set.

In **Visitor** interface Click **Basic Management > Visitor Levels**:

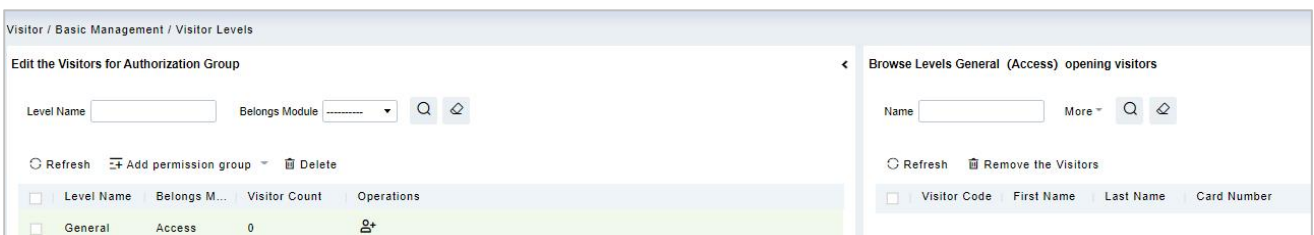

Figure 10- 43 Visitor Level Interface

10.5.4.1 Add Permission Group

In this option you can give access, elevators, and entrance control permissions to the visitors

- **Add Access Levels**

To add Access Levels.

Operating Steps:

Step 1: In the **Visitor Module**, click **Basic Management > Visitor Levels > Add Access Levels**

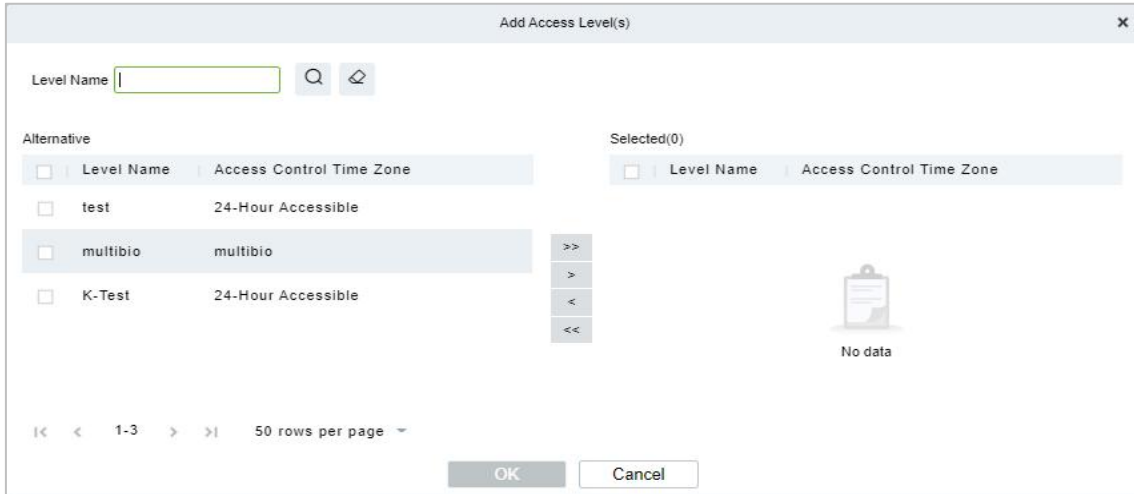

Figure 10- 44 Add Access Level Interface

Step 2: Set a visitor level name, select one or more access levels, click **>** or **>>** to move into the Selected menu. Click **OK**.

Step 3: Allocate the Access levels for the visitor when registering.

- **Add Elevator Levels**

To add Elevator Levels.

Operating Steps:

Step 1: In the **Visitor Module**, click **Basic Management > Visitor Levels > Add Elevator Levels**.

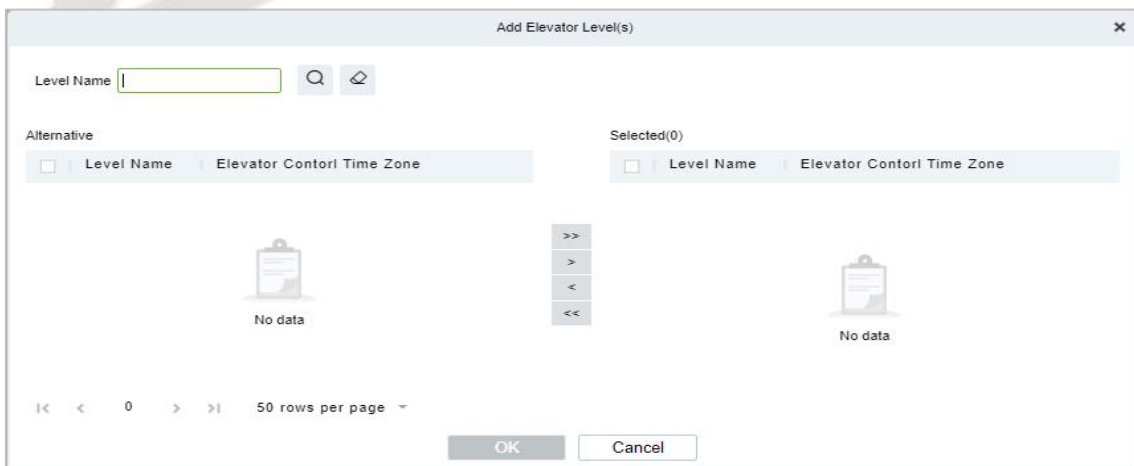

Figure 10- 45 Add Elevator Level Interface

Step 2: Set a visitor level name, select one or more access levels, click **>** or **>>** to move into the Selected menu. Click **OK**.

Step 3: Allocate the Elevator levels for the visitor when registering.

● **Add Entrance Control Level**

To add Entrance Control Levels.

Operating Steps:

Step 1: In the **Visitor Module**, click **Basic Management > Visitor Levels > Add Entrance Control Level**

Step 2: Set a visitor level name, select one or more access levels, click **>** or **>>** to move into the Selected menu. Click **OK**.

Step 3: Allocate the Elevator levels for the visitor when registering.

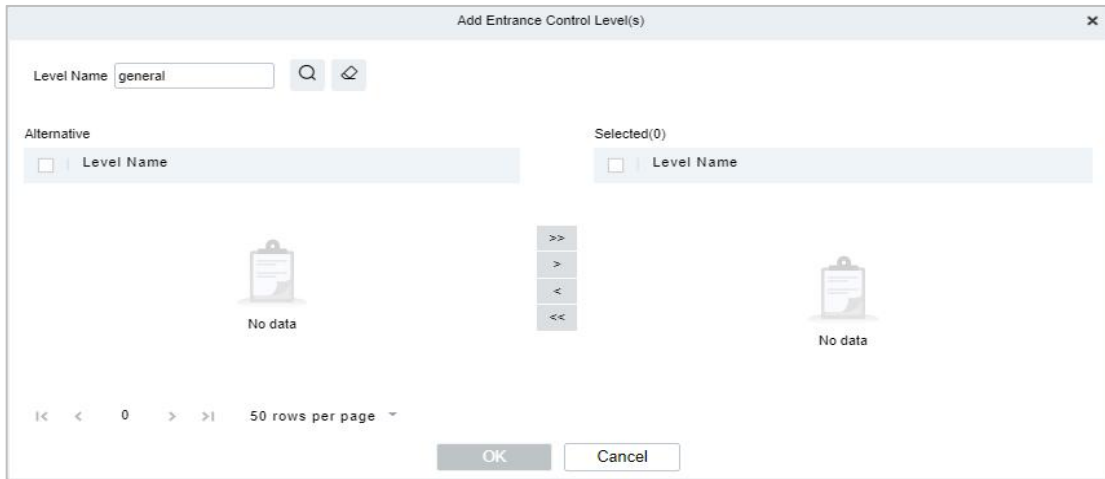

Figure 10-46

Figure 10-41 Add Entrance Control Level Interface

10.5.4.2 Delete Levels

In the **Visitor** module, click **Basic Management > Visitor Levels**, select a visitor level and click **Delete** to delete the visitor level.

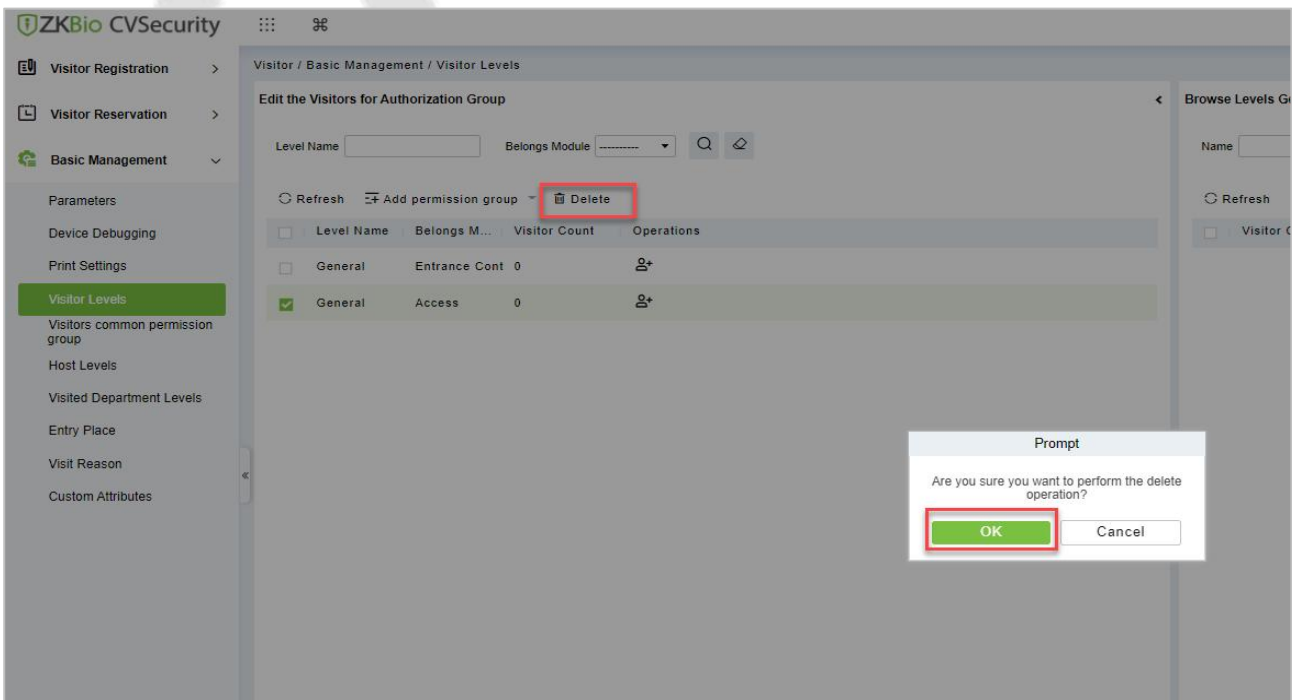

Figure 10-47 Delete Level Interface

Click **OK** to perform the delete operation.

10.5.4.3 Add Visitors to Levels (Browse Level)

Adding visitors to levels

Operating Steps

Step 1: In the **Visitor** module, click **Basic Management > Visitor Levels**.

Step 2: Select the Visitor name click on the icon  under the operation categories.

Step 3: Select one or more visitors, click  or  to move into the Selected menu. Click **OK**.

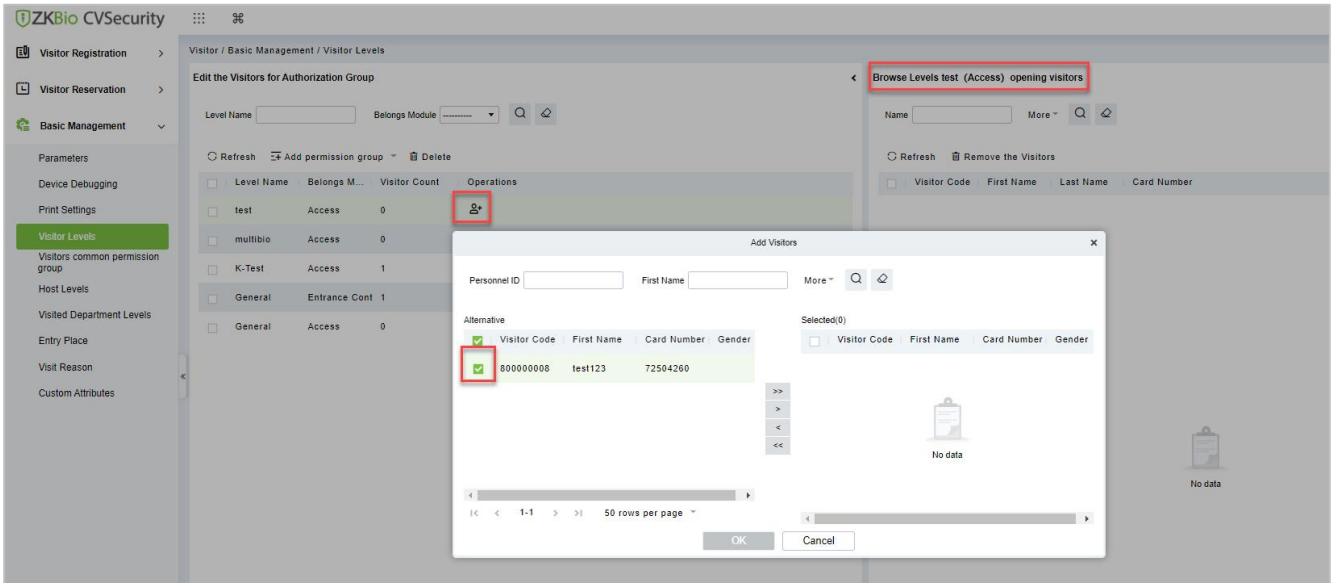

Figure 10- 48 Add Visitor Interface

Step 4: After clicking **OK** the processing window will appear like Figure 10-49 shows below.

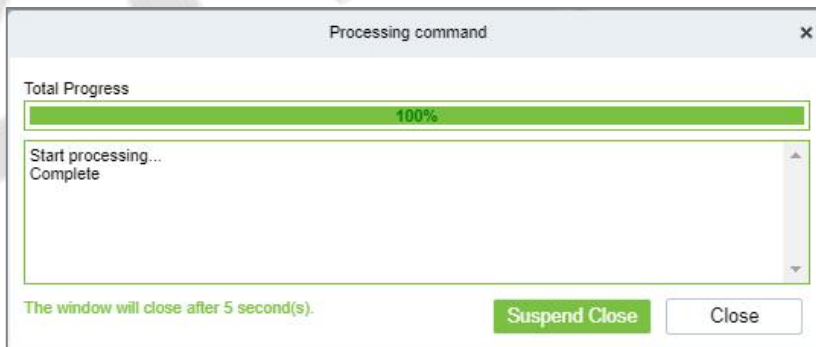

Figure 10- 49 Processing Command Interface

10.5.4.4 Remove Visitors from Browse Level

Removing visitors from the levels.

Operating Steps:

Step 1: In the **Visitor Module**, click **Basic Management > Visitor Levels**

Steps 2: Select the visitor details to be deleted, Click **Remove the Visitor** as shown in Figure 10-50.

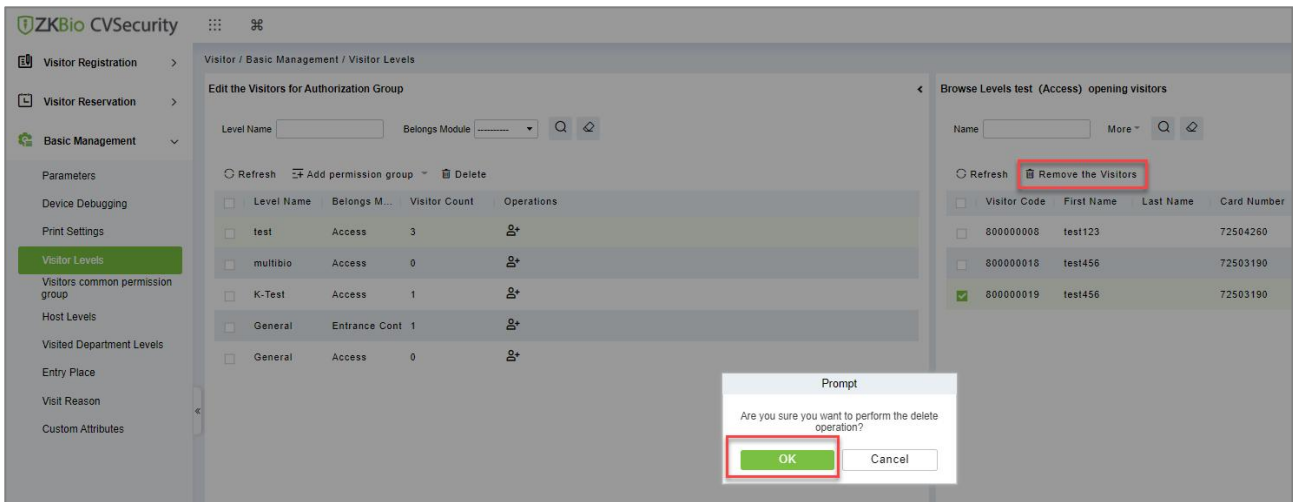

Figure 10- 50

Figure 10-45 Remove Visitors from Browse Level

Step 3: Click **OK** to perform the delete operation.

10.5.5 Visitor Common Permission Group

This interface displays a list of all visitor permission groups in the visitor system. After setting up the visitor permission group, you can assign access control/passage/witness permission to visitors when registering visitors.

10.5.5.1 Add Permission Group

In this option you can give access, elevators, and entrance control permissions to the visitors.

- **Add Access Level**

To add Access Level Group

Operating Steps:

Step 1: In the **Visitor** module, select **Basic Management > Visitor Common Permission Group**.

Step 2: In the Visitor Permission Group interface, click **Add Permission Group**, select **Add Access Level**, and then add the corresponding permissions.

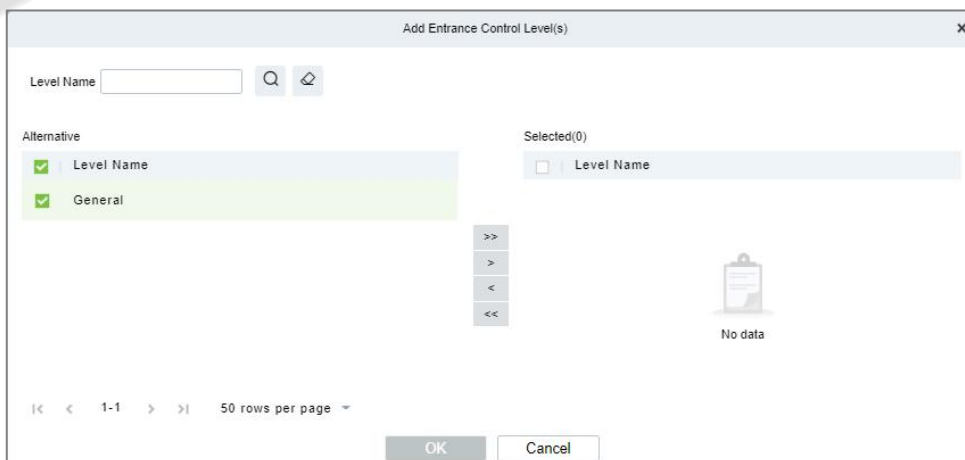

Figure 10- 51 Visitor Permission Group Adding Interface

Set a visitor level name, select one or more access levels, click **>** or **>>** to move into the Selected menu. Click **OK**.

Step 3: In the **Visitor** module, select **Visitor Registration > Entry Registration** interface, and click **Entry Registration** to assign personnel visitor permissions.

Figure 10- 52 Visitor Add Visitor Permission Interface

● **Add Elevator Level**

To add Access Level Group

Operating Steps:

Step 1: In the **Visitor** module, select **Basic Management > Visitor Common Permission Group**.

Step 2: In the Visitor Permission Group interface, click **Add Permission Group**, select **Add Elevator Level**, and then add the corresponding permissions.

Figure 10- 53 Visitor Permission Group Adding Interface

Set a visitor level name, select one or more access levels, click **>** or **>>** to move into the Selected menu. Click **OK**.

● **Add Entrance Control Level**

To add Access Level Group

Operating Steps:

Step 1: In the **Visitor** module, select **Basic Management > Visitor Common Permission Group**.

Step 2: In the Visitor Permission Group interface, click **Add Permission Group**, select **Add Entrance Control Level**, and then add the corresponding permissions.

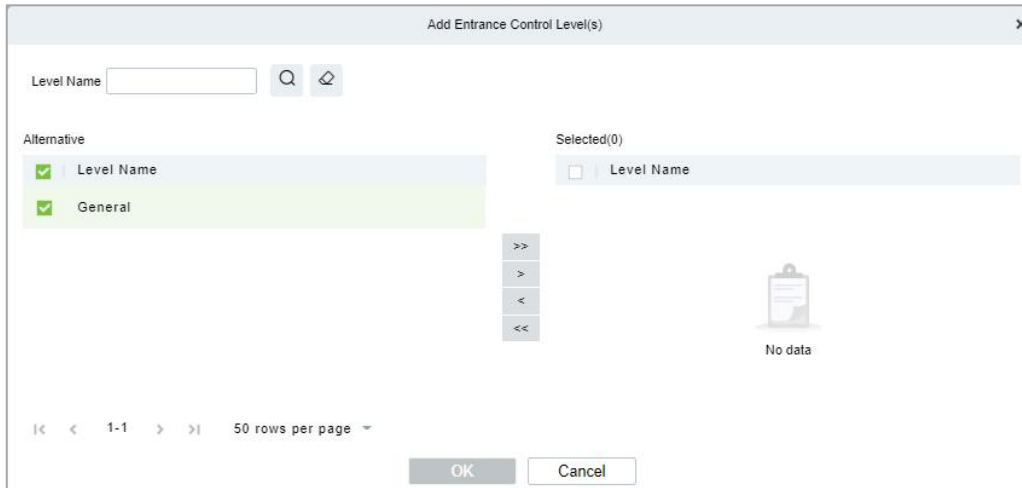

Figure 10- 54 Visitor Permission Group Adding Interface

Set a visitor level name, select one or more access levels, click **>** or **>>** to move into the Selected menu. Click **OK**.

10.5.5.2 Delete Levels

In the **Visitor Module**, click **Basic Management > Visitor Common Permission Group**, select a visitor level and click **Delete** to delete the visitor level.

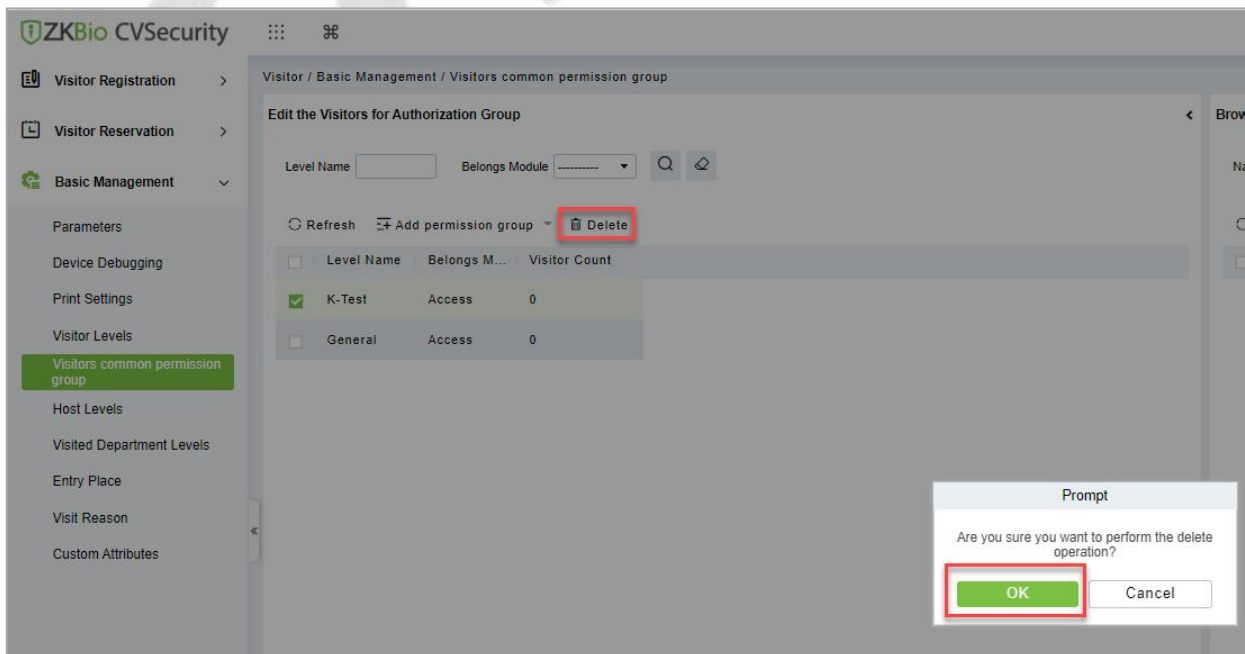

Figure 10- 55 Delete Level Interface

Click **OK** to perform the delete operation.

10.5.5.3 Remove Visitors from Browse Level

Operating Steps:

Step 1: In the **Visitor Module**, click **Basic Management > Visitor Common Permission Group**

Step 2: Select the visitor details to be deleted, Click **Remove the Visitor**.

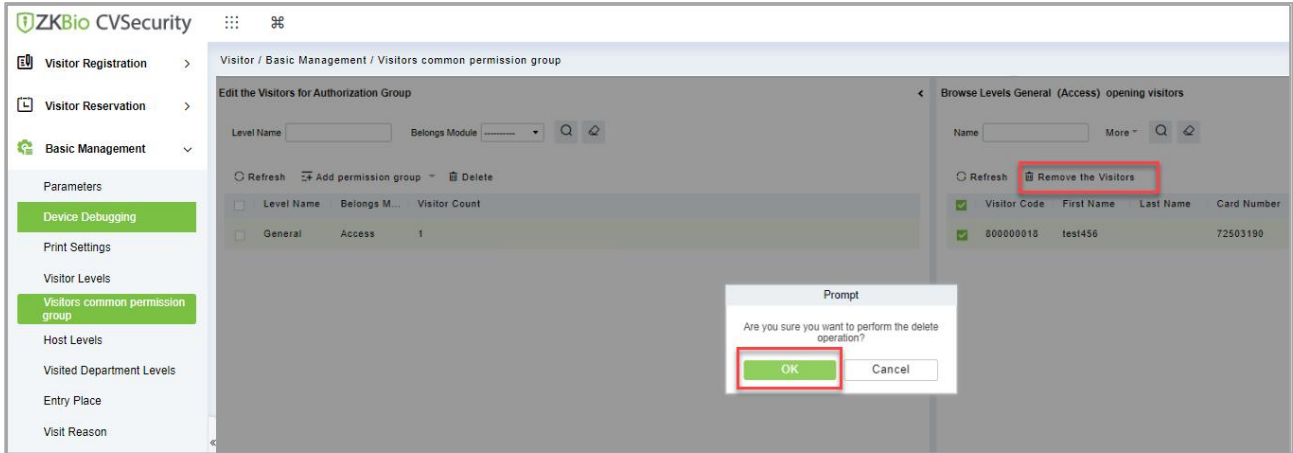

Figure 10- 56 Remove Visitors from Browse Level

Step 3: Click **OK** to perform the delete operation.

10.5.6 Host Level

After setting up the visitor permission group, you can set the visitor permission group according to the visited person or department in the Personnel module. After setting up, visitors who visit the visited person or department have this assigned permission by default.

10.5.6.1 Set Up Permission Groups by Interview (New)

This paper introduces the configuration Steps of setting permission groups according to the interview in.

Operating Steps:

Step 1: In the **Visitor** module, select **Basic Management > Host Level**.

Step 2: In the Setting Permission Group by Interviewee interface, click **New** to add interviewee information.

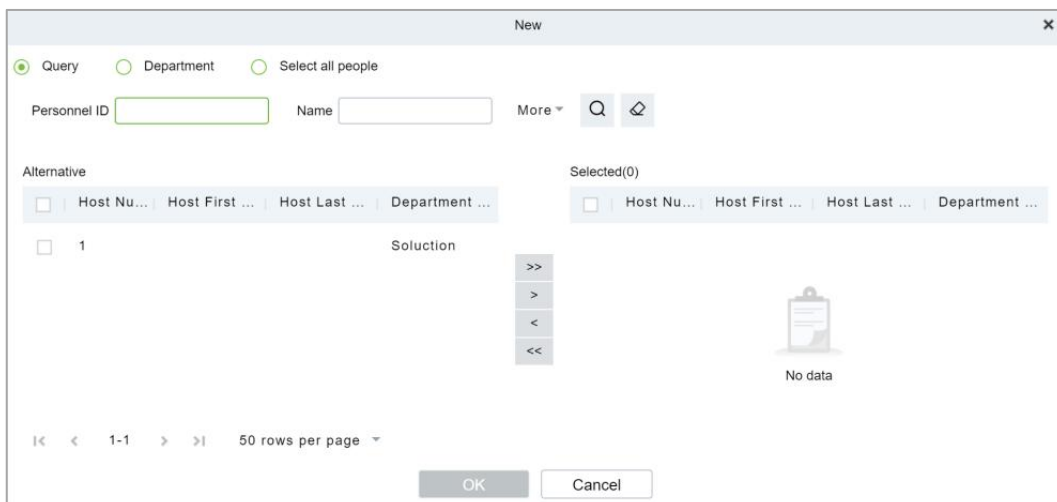



Figure 10- 57 New Interface for Interviewee

Step 3: After the new information is successfully added, click **Add Visited Levels**  under operations. After the respondent adds the corresponding permissions, this permission group will be distributed to the visitor when the visitor registers, and the visitor will have the permissions possessed by this permission group.

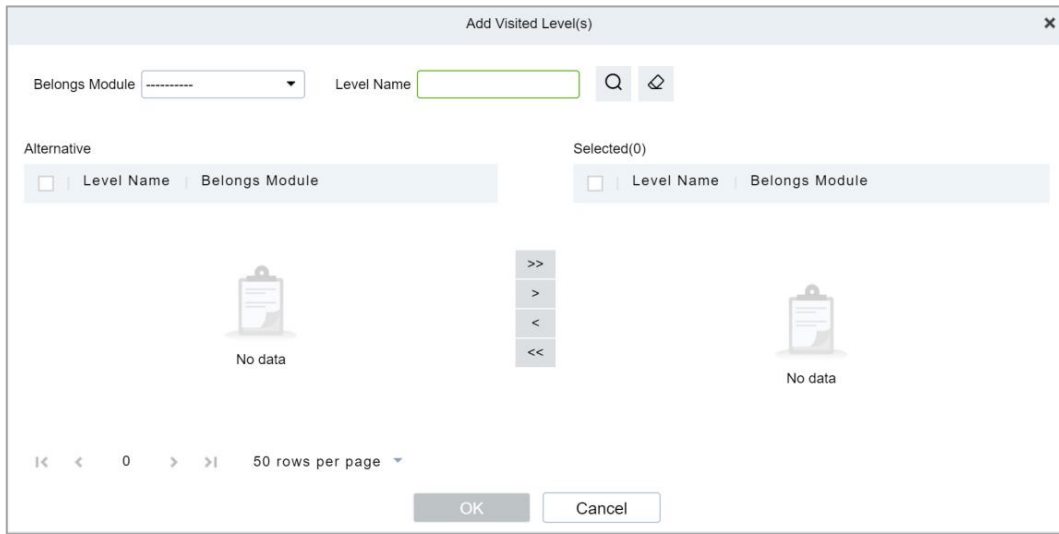

Figure 10- 58 Add Visitor Permissions Interface

10.5.6.2 Delete Levels

In the **Visitor** module, click **Basic Management > Host Level**, select a Host and click **Delete** to delete the Host level.

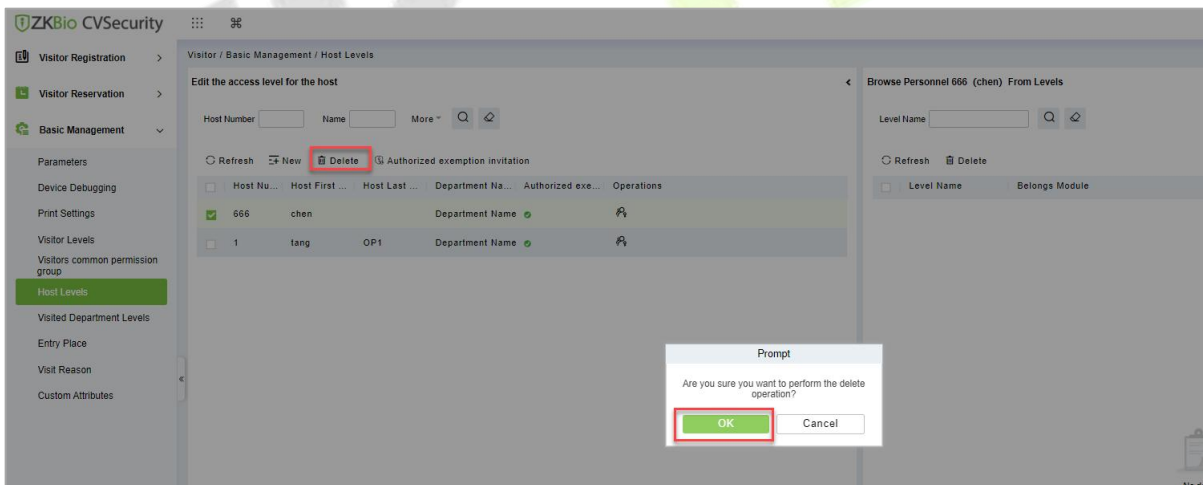

Figure 10- 59 Delete Level Interface

Click **OK** to perform the delete operation.

10.5.6.3 Authorized Exemption Invitation

To send authorized exemption invitation to the interviewee.

Operating Steps:

Step 1: In the **Visitor** module, click **Basic Management > Host Level**, select Interviewee

Step 2: Click **Authorized Exemption Invitation** and select **Yes** or **No** from the drop-down list as shown in Figure 10-60.

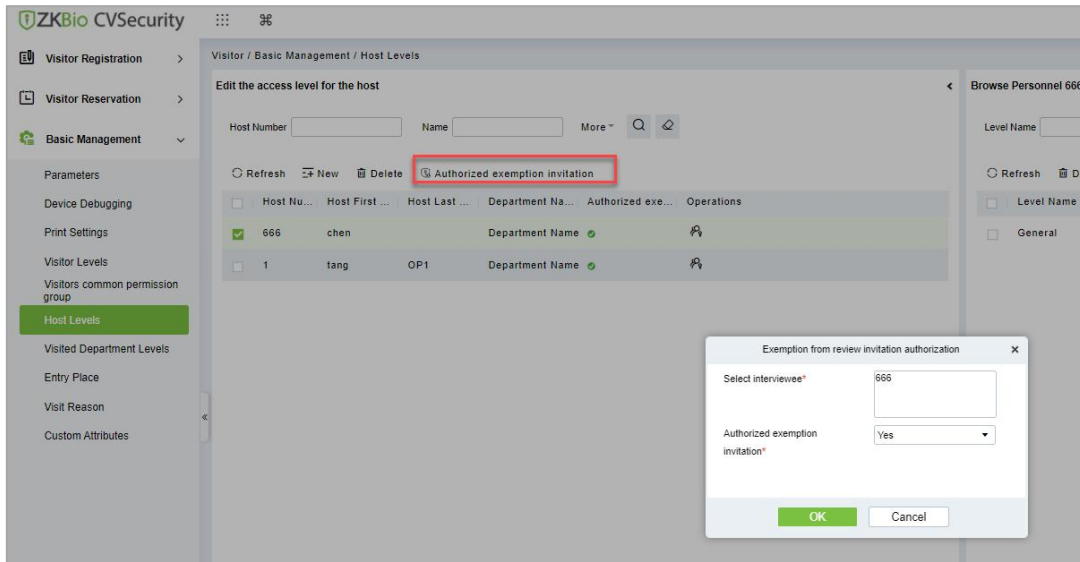

Figure 10- 60 Authorized Exemption Invitation Interface

Step 3: Click **OK** to send authorized exemption invitation to the interviewee.

10.5.6.4 Remove Visited Host Level from Browse Level (Delete)

Removing visitors from the levels.

Operating Steps:

Step 1: In the **Visitor** module, click **Basic Management > Host Level**.

Step 2: Select the visited level details to be deleted, click **Delete**.

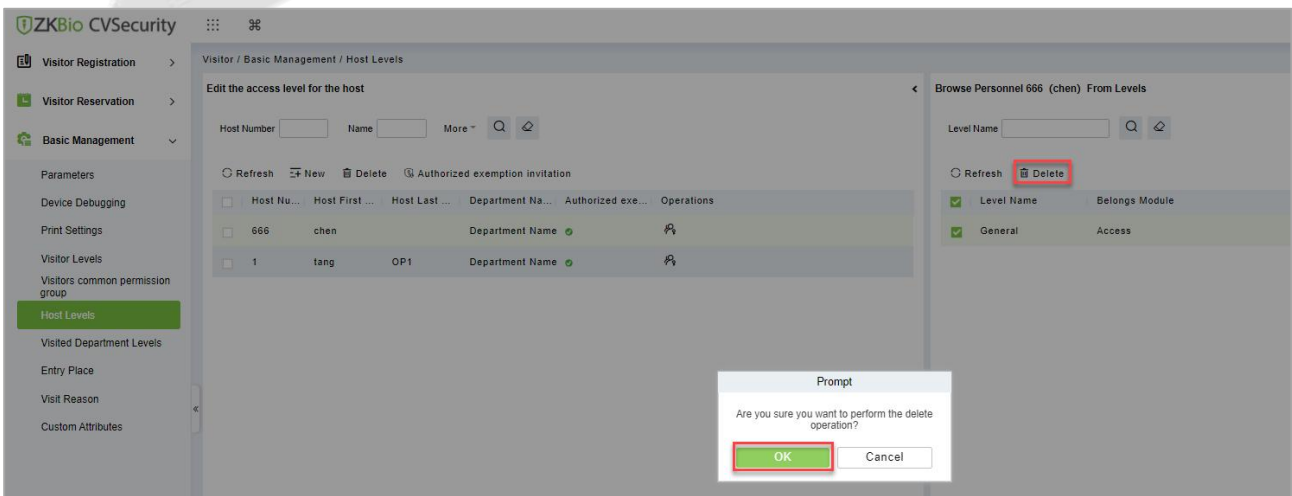

Figure 10- 61 Remove Visited Level from Browse Level

Step 3: Click **OK** to perform the delete operation.

10.5.7 Set Up Permission Groups by Visited Department (Visited Department Level)

This paper introduces the configuration Steps of setting permission groups by department in.

10.5.7.1 Add Permission Group by Visited Department (New)

Operating Steps:

Step 1: In the **Visitor** module, select **Basic Management > Visited Department**.

Step 2: In the Setting Permission Group by Visited Department interface, click **New** to add the visited department.

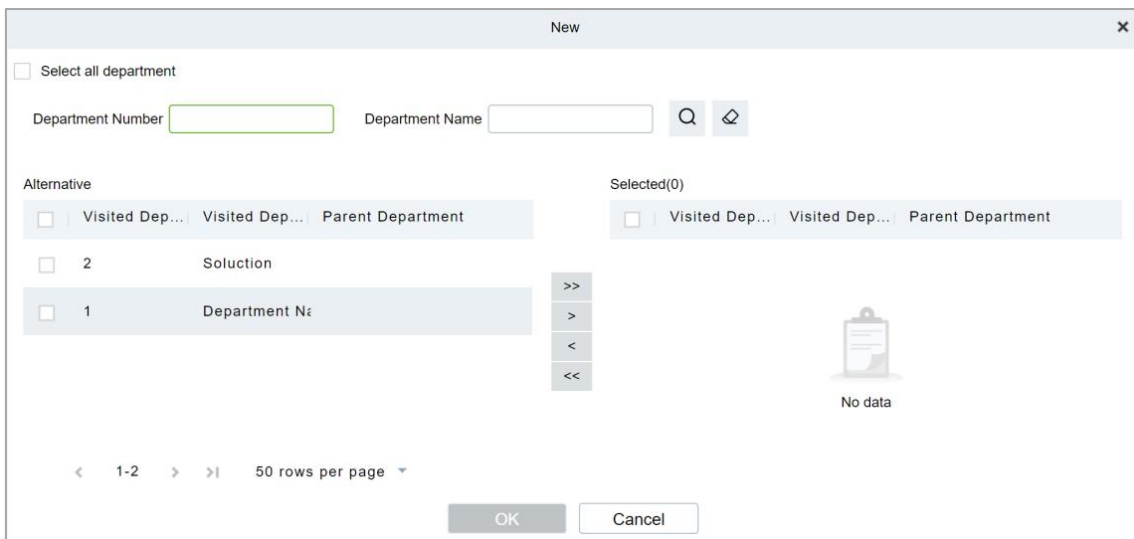



Figure 10- 62 Add Department Interface

Step 3: In the interface of editing permission group for visited department, click **Add Visited Level**  under Operation. After adding the corresponding permission, when the visitor registers, this permission group will be distributed to the visitor, and the visitor will have the permission of this permission group.

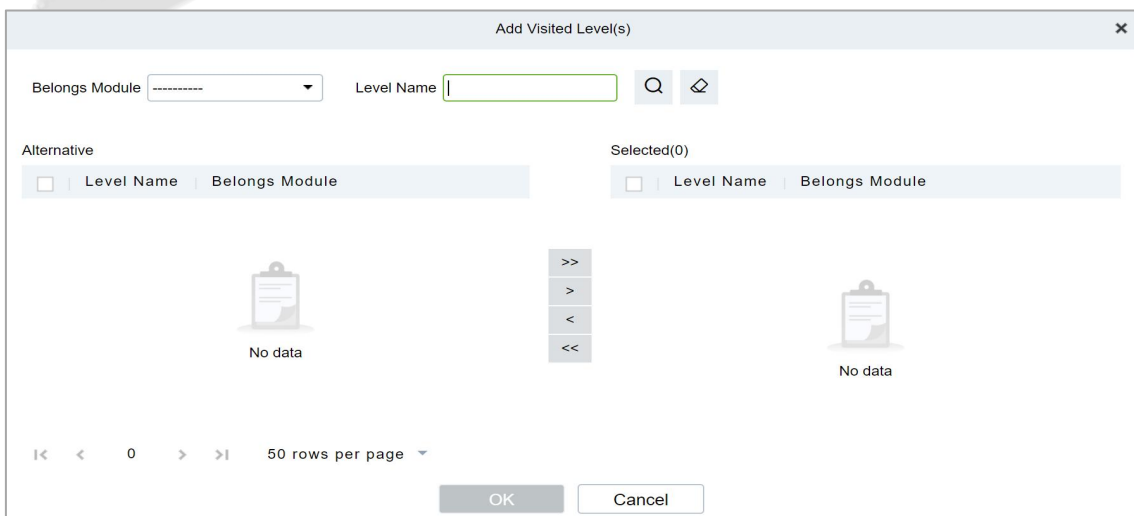

Figure 10- 63 Add Department Permission Interface

10.5.7.2 Delete Levels

In the **Visitor** module, click **Basic Management > Host Level**, select a visited department and click **Delete** to delete the Host level.

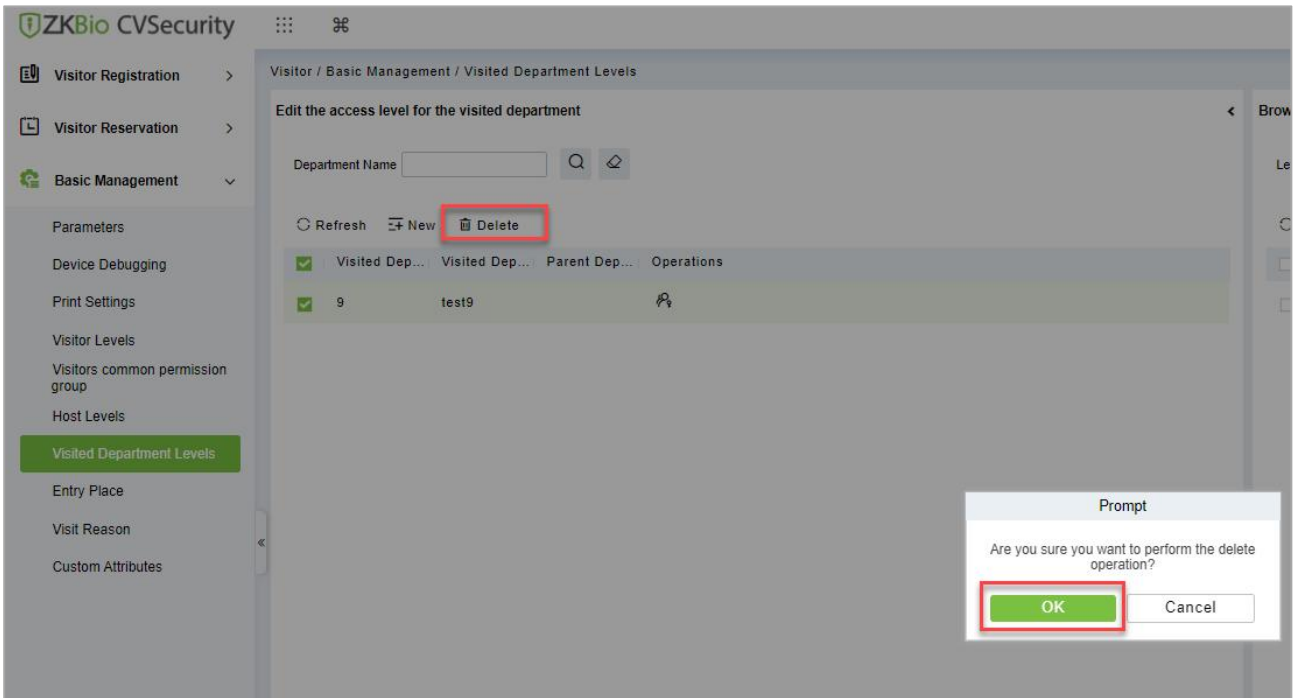

Figure 10- 64 Delete Visited Department Interface

Click **OK** to perform the delete operation.

10.5.7.3 Remove Visited Department Level from Browse Level (Delete)

Removing visitors from the levels.

Operating Steps

Step 1: In the **Visitor** module, click **Basic Management > Host Level**

Steps 2: Select the visited Level details to be deleted, click **Delete**.

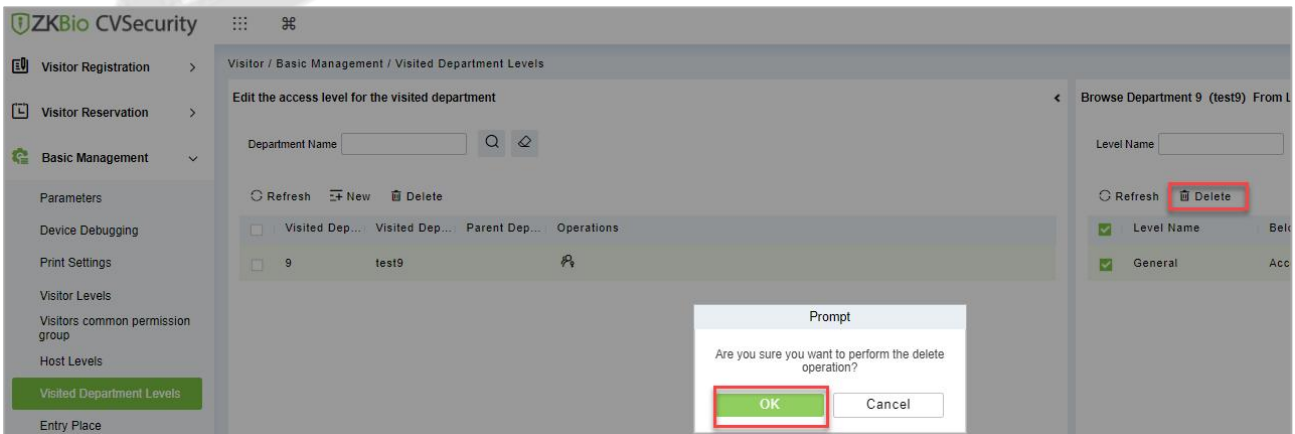

Figure 10- 65 Remove Visited Level from Browse Level

Step 3: Click **OK** to perform the delete operation.

10.5.8 Entry Place

Only the registered platform (including PC platform and visitor plane) can register and sign off visitors.

This interface displays a list of all registered places in the visitor system. Displays fields such as enlistment location name, IP address, area name, and so on.

10.5.8.1 Non-Use Of Passenger Planes (New)

Introduces the configuration Steps of registering locations in ZKBio CVSecurity.

Operating Steps:

Step 1: In the **Visitor** module, select **Basic Management > Entry Place**.

Step 2: In the registration location interface, click **New** and select **Ordinary Computer** as the visitor machine type, as shown in Figure 10-66. Please refer to Table 10-12 for parameter description.

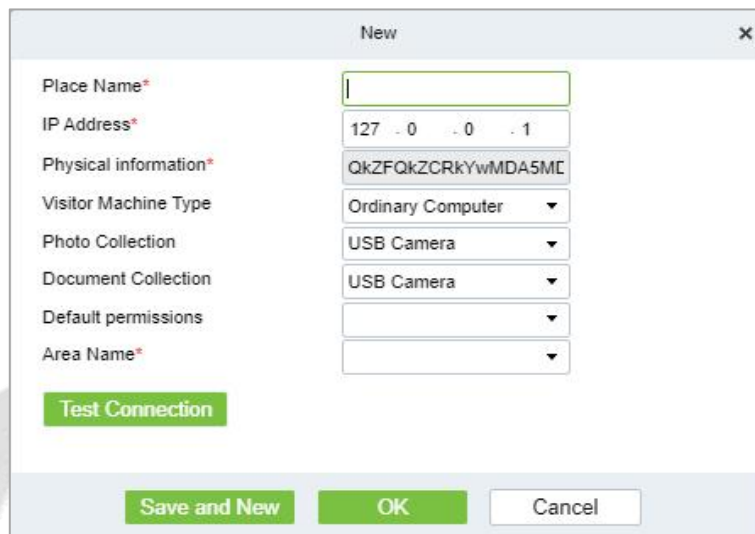

Figure 10- 66 Ordinary Computer Entry Place Interface

Parameter	Description
Name of Registration Place	Any character, no more than 50, not repeatable.
IP Address	Register the IP address of the computer used by the platform of visitor information and read the IP address of the local computer by default, which can be edited.
Physical Information	The physical information of the computer used by the platform for registering visitor information is automatically filled in by default and cannot be edited.
Type of Visitor Machine	By default, it is an ordinary computer. When connecting the visitor machine, select the visitor machine type: desktop visitor machine second generation, ID2000.
Photo Collection	Select the type of camera installed by customers, which is divided into USB camera, webcam, and dual-camera altimeter. Description: The server side of the box does not currently support external "dual camera high camera".
Certificate Collection	Select the certificate collection equipment installed by customers, which is divided into USB camera, altimeter, scanner, and dual-camera altimeter. Description: The box server does not support external "altimeter, scanner and dual-camera altimeter" for the time being.

Parameter	Description
Default Permissions	Select the default access rights for visitors registered at this level of location.
Area Name	Add the name of the area to which the registration place belongs, and the visiting registration record of each registration place will be filtered according to the area of the registration place

Table 10- 12 Description of Entry Place Parameters

10.5.8.2 Use Of Visitor Machine

Introduces the configuration Steps of registering locations in ZKBio CVSecurity.

Operating Steps:

Step 1: In the **Visitor** module, select **Basic Management > Entry Place**.

Step 2: In the registration location interface, click **New**, and select the visitor type as **Desktop Visitor Second Generation, ID2000**, as shown in Figure 10-62. Please refer to Table 10-12 for parameter description.

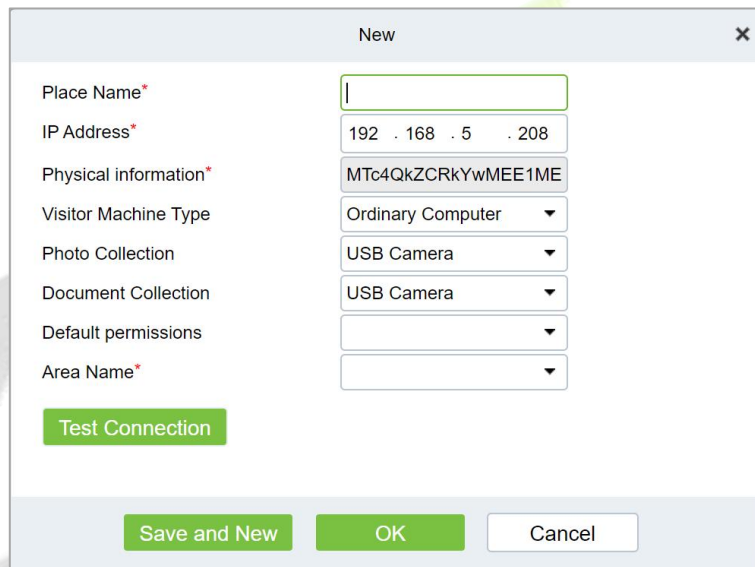

Figure 10- 67 Interface of Visiting Passenger Airline Entry Place

Parameter	Description
Name of Registration Place	Any character, no more than 50, cannot repeat.
IP Address	Register the IP address of the computer used by the platform of visitor information and read the IP address of the local computer by default, which can be edited.
Physical Information	The physical information of the computer used by the platform for registering visitor information is automatically filled in by default and cannot be edited.
Type of Passenger Plane	By default, it is an ordinary computer. When connecting the visitor, select the visitor type: desktop visitor second generation, ID2000.
Photo Collection	Select the type of camera installed by customers, which is divided into USB camera, webcam, and dual-camera altimeter. Description: The server side of the box does not support the external "dual-camera altimeter" equipment for the time being.

Parameter	Description
Certificate Collection	Select the certificate collection equipment installed by customers, which is divided into USB camera, altimeter, scanner, and dual-camera altimeter. Description: The box server does not support external "altimeter, scanner and dual-camera altimeter" for the time being.
Default Permissions	Select the default access rights for visitors registered at this level of location.
Area Name	Add the name of the area to which the registration place belongs, and the visiting registration record of each registration place will be filtered according to the area of the registration place

Table 10-12 Description of Registration Location Parameters

10.5.8.3 Delete

Operation Steps:

Step 1: In the **Visitor Module**, click **Basic Management > Entry Place**, select the place name to be deleted.

Step 2: Click **Delete** to delete the selected place.

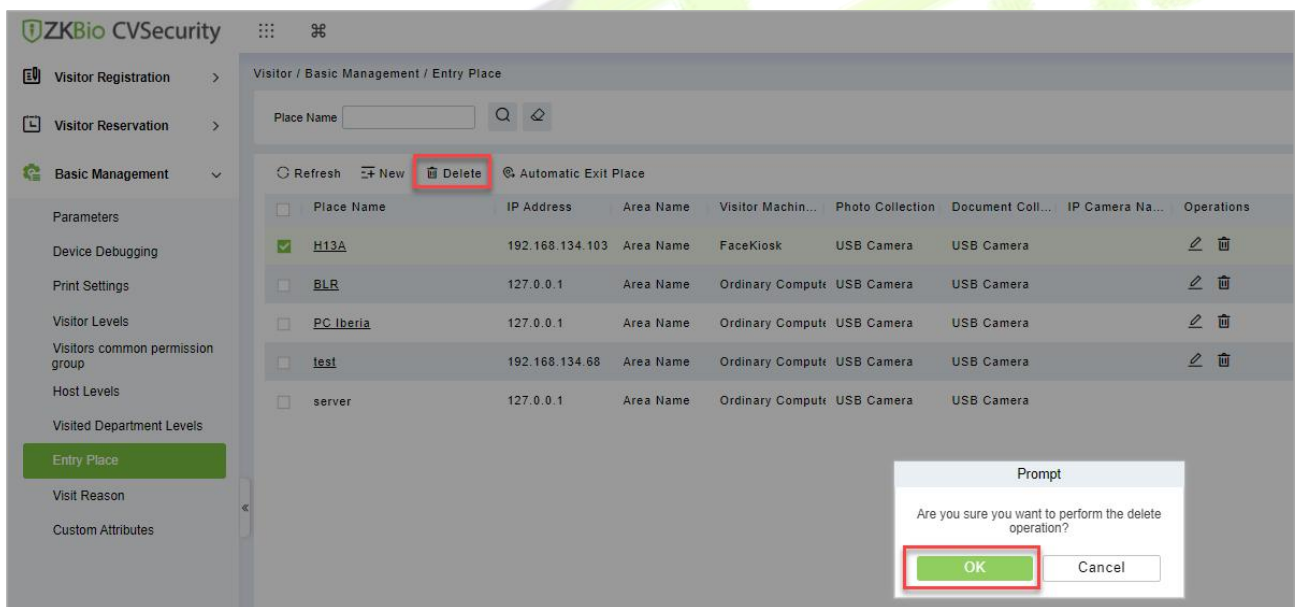

Figure 10- 68 Interface of Visiting Passenger Airline Entry Place

Step 3: Click **OK** to perform the delete operation.

10.5.8.4 Automatic Exit Place

To set automatic Exit place.

Operation Steps:

Step 1: In the **Visitor Module**, click **Basic Management > Entry Place**, click **Automatic Exit Place** option.

Step 2: Select the place to be set as automatic exist place and click **OK**.

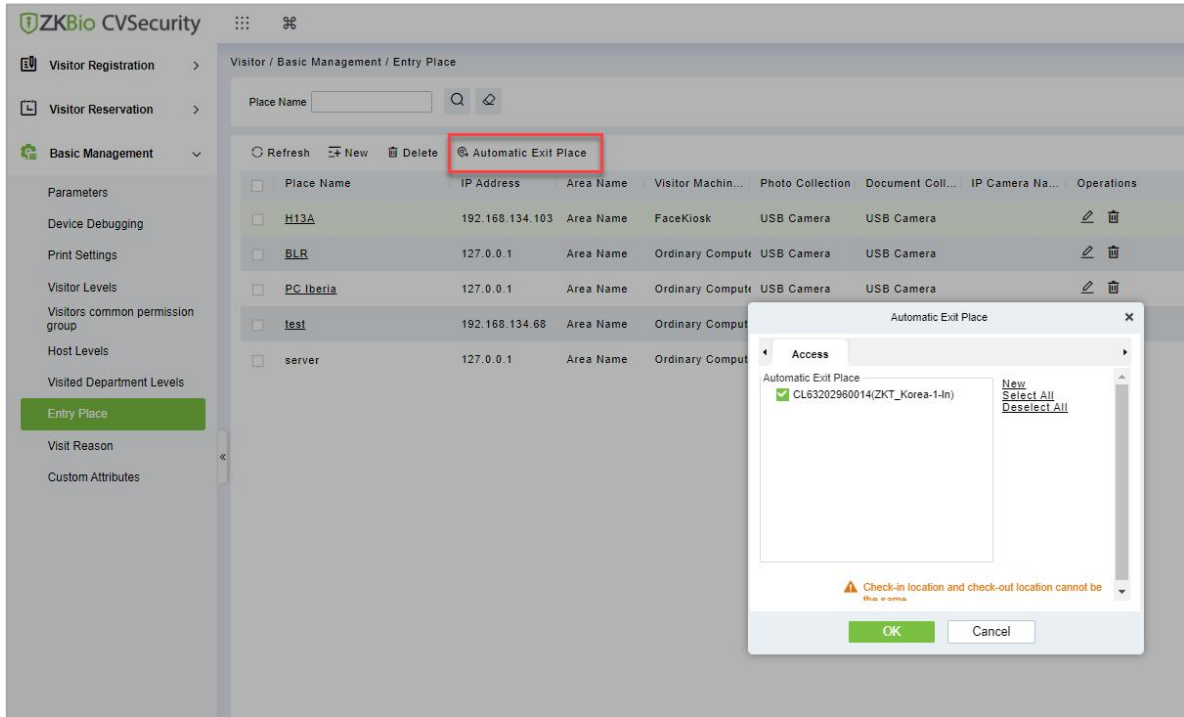

Figure 10- 69 Automatic Exit Place Interface

Step 3: Click **New** to add place as automatic exit place and select the place reader name (Device place) from the appeared window. Click **OK** to save the data.

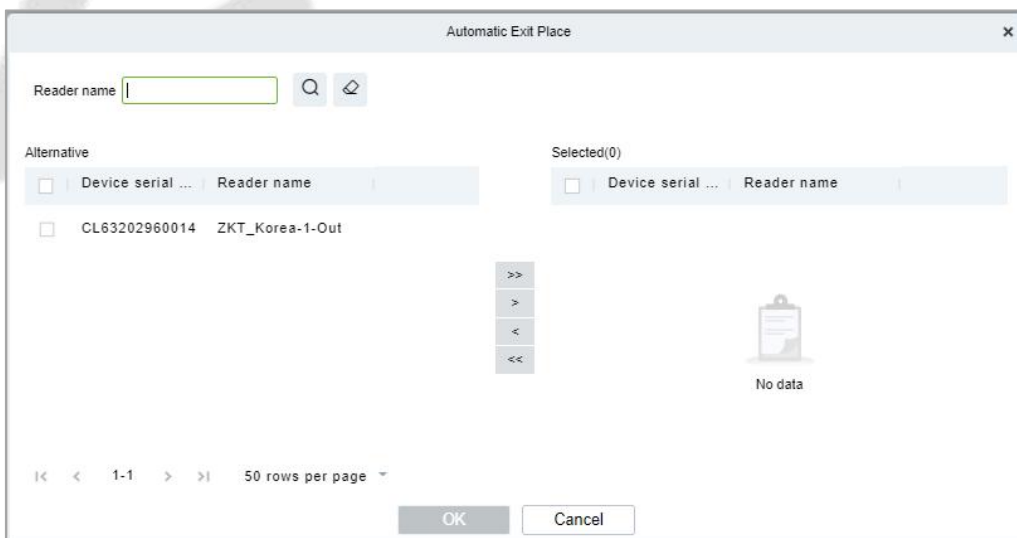

Figure 10- 70 Add Place as Automatic Exit Place

Step 4: Repeat the step 2 to set the newly added place as automatic exit place.

10.5.9 Visit Reason

You can Add, Delete or Edit visit reason in this interface, so that you can select either from them at the entry registration page.

10.5.9.1 To Add Visit Reason (New)

Operation Steps:

Step 1: In the **Visitor** module, click **Basic Management > Visit Reason > New**.

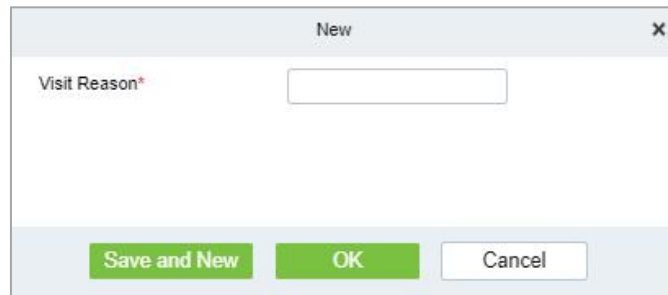

Figure 10- 71 Add Place as Automatic Exit Place

Step 2: Click **OK** to finish.

10.5.9.2 Delete

Operation Steps:

Step 1: In the **Visitor** module, click **Basic Management > Visit Reason**, select visit reason to be deleted.

Step 2: Click **Delete** to delete the selected visit reason.

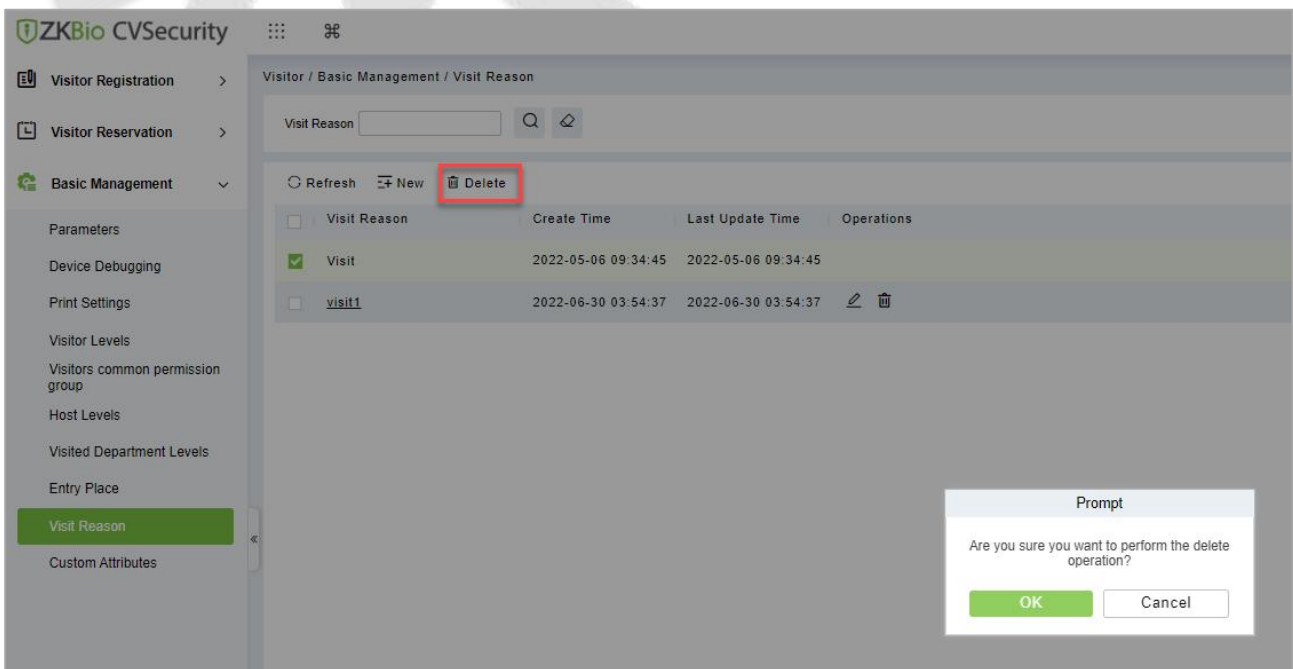

Figure 10- 72 Delete Visit Reason

Step 3: Click **OK** to perform the delete operation.

10.5.10 Custom Attributes

If you want to add or delete a specific field on the registration page, then you can use this function.

10.5.10.1 To Add Custom Attributes (New)

In this interface you can add any specific field on the registration page.

Operation Steps:

Step 1: In the **Visitor Module**, click **Basic Management > Custom Attributes**, click **New** to add a specific field on the registration page.

Step 2: Enter the Attribute name, select the field type as Pull down, Multiple Choice, Single Choice or Text.

If you select any of the type except Text, then you have to mention the attribute value(s). Use a semicolon to separate the values. Enter Row and Column as required and choose Yes or No according with requirement.

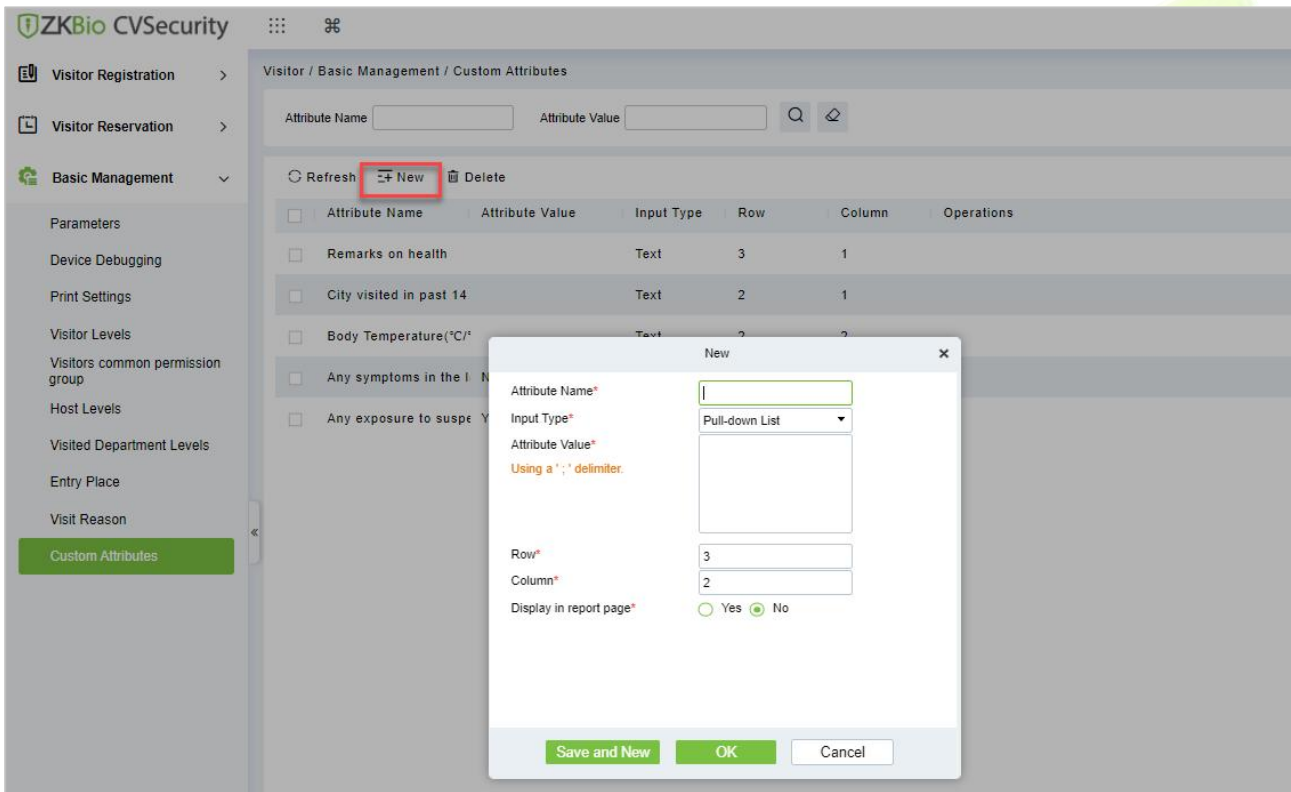

Figure 10- 73 Custom Attribute Interface

Step 3: Click **OK** to add the attribute.

Parameter	Description
Attribute Name	Enter the attribute name.
Input Type	Select the input type from the drop-down list such as Pull down, Multiple Choice, Single Choice or Text.
Attribute Value	Enter the attribute value. n attribute has multiple values, you can separate them with a semicolon. If you select text as input type of the attribute, then no need to add the attribute value.
Row	Enter the row number as required.

Parameter	Description
Column	Enter the column number as required.
Display in Report Page	If an attribute should be displayed on report pages, select Yes . Otherwise select No .

Table 10- 13 Description of Entry Place Parameters

10.5.10.2 Delete Custom Attributes

To delete customized attributes.

Operation Steps:

Step 1: In the **Visitor** module, click **Basic Management > Custom Attributes** and select the attribute to be deleted.

Step 2: Click **Delete** to delete a specific field on the registration page.

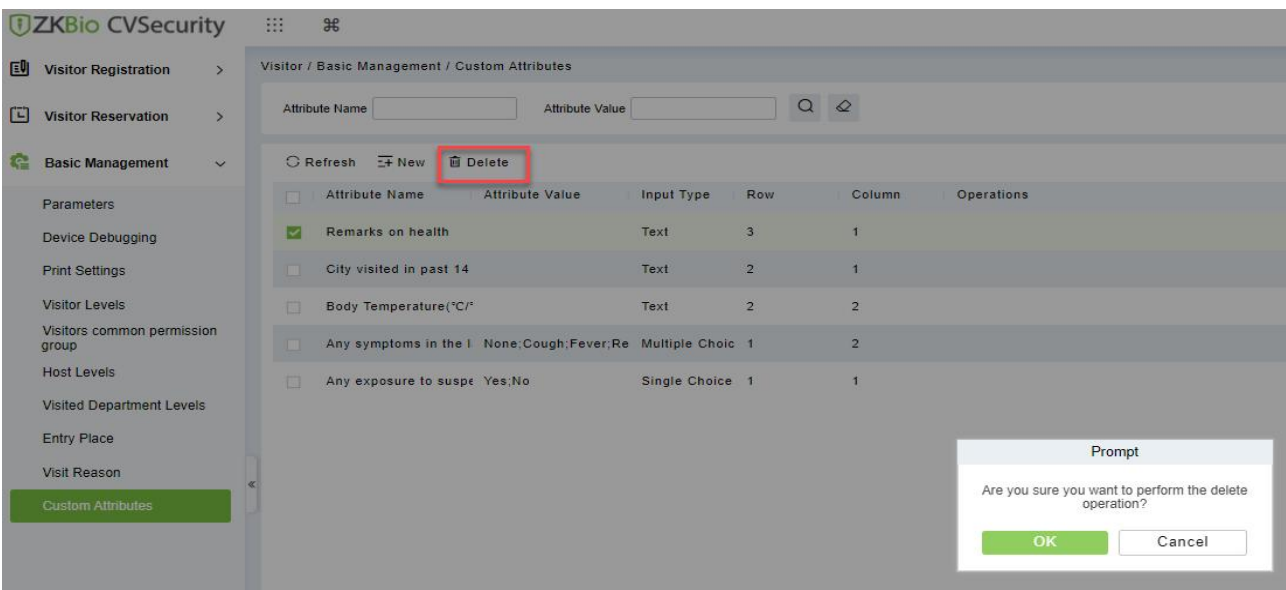

Figure 10- 74 To Delete Custom Attribute

Step 3: Click **OK** to perform the delete operation.

10.6 Advanced

10.6.1 Category

This interface allows you to add or delete the visitor category.

10.6.1.1 To Add New Visitor Category

Operation Steps:

Step 1: In the **Visitor** module, click **Advanced > Category** and click **New** to add a new category.

Step 2: Enter the type of category and remarks as shown in Figure 10-75.

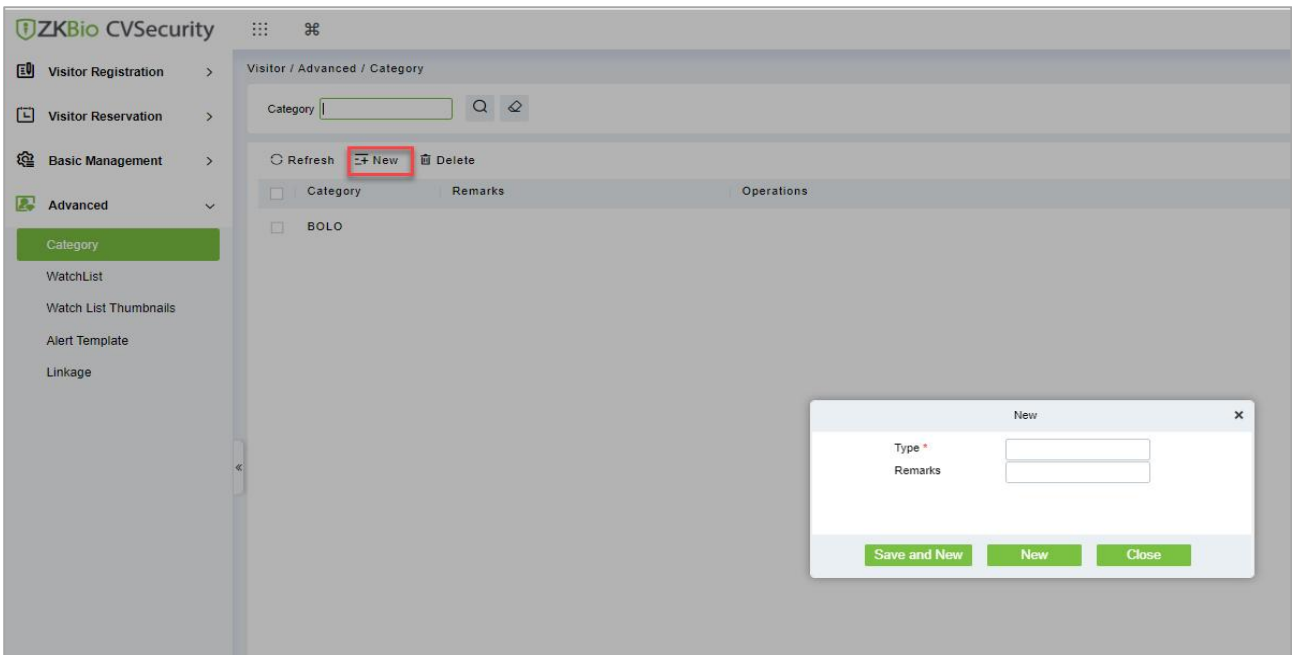

Figure 10- 75 Category Interface

Step 3: Click **OK** to save the data.

Parameter	Description
Type	Enter the type of category.
Remarks	Enter the remarks about the category (Optional).

Table 10- 14 Description of Category Parameters

10.6.1.2 To Delete Category

Operation Steps:

Step 1: In the **Visitor** module, click **Advanced > Category** and select the category to be deleted.

Step 2: Click **Delete** and then click **OK** to perform the delete operation.

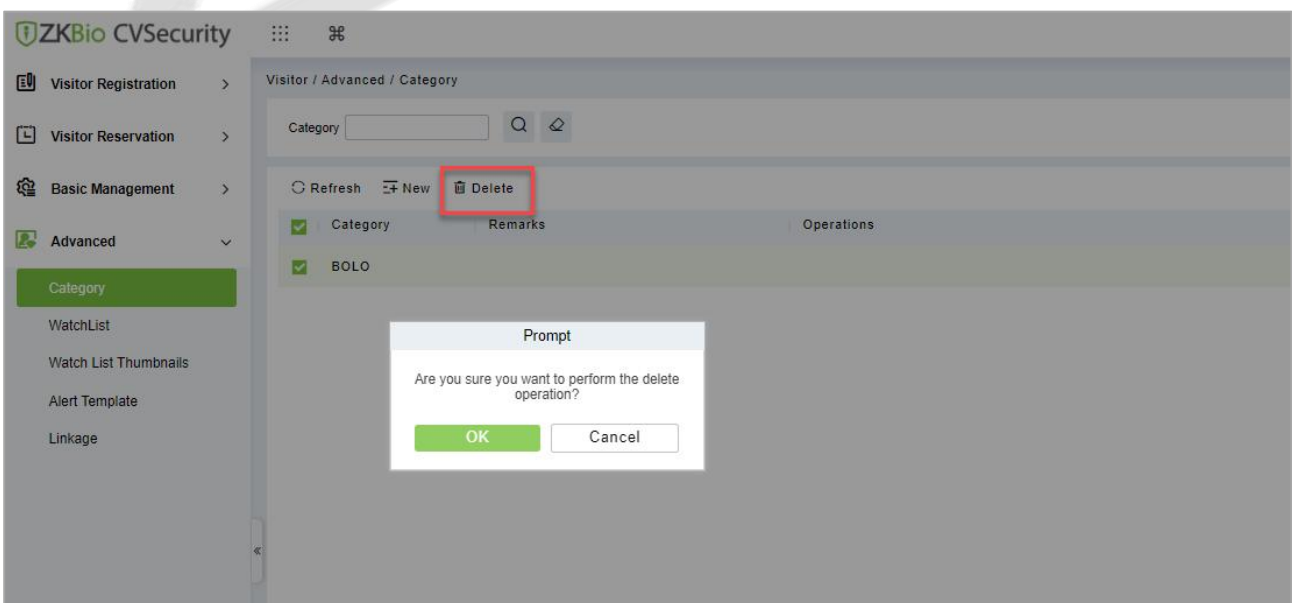

Figure 10- 76 To Delete Category

10.6.2 WatchList

Watch List interface displays the list of visitor information, and you can Add, Delete, Enable, or Disable the visitors.

10.6.2.1 To Add Visitor (New)

Step 1: In the **Visitor** module, click **Advanced > WatchList** and click **New** to add visitor.

Step 2: Enter the Visitor details such as Type, Full Name, Category, Certificate Type and Certificate Number.

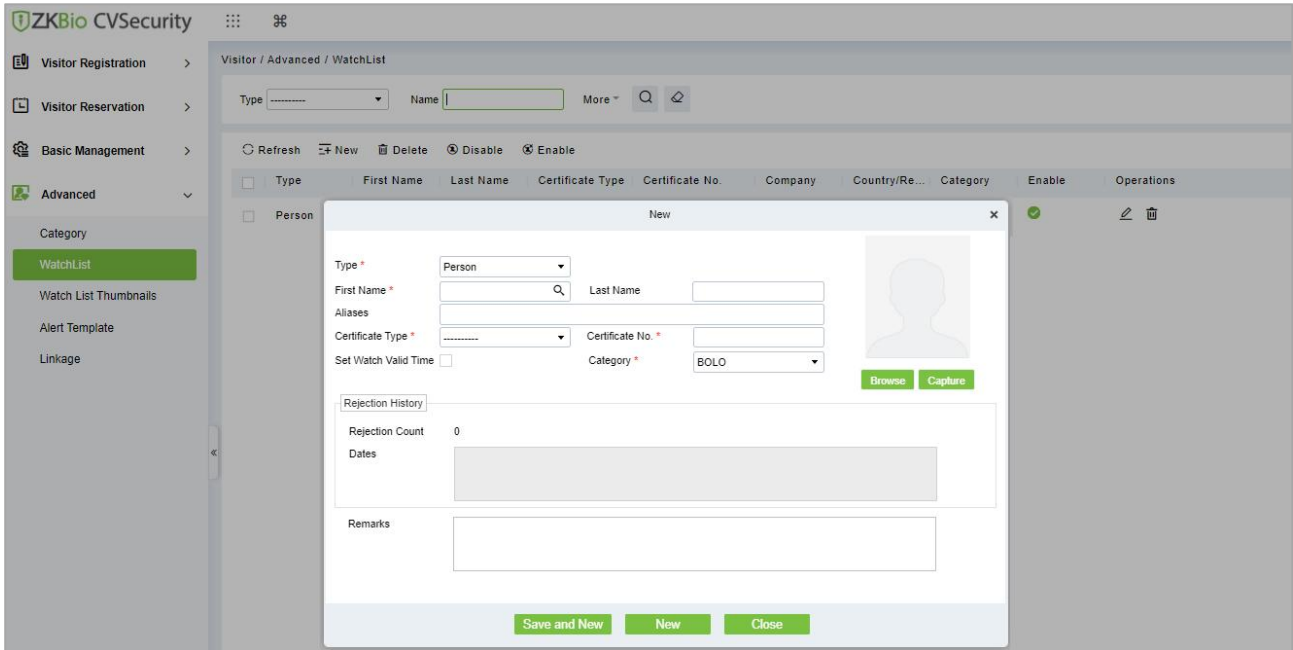

Figure 10- 77 WatchList Interface

Step 3: Click **Save and New** to save the details.

Parameter	Description
Type	Select type from the drop-down list; Available types are Person, Company, Category/Country.
First and Last Name	Select visitor name using search icon. If you selected company as type, then enter the company name.
Aliases	You can enter the more familiar name of visitor if it needed.
Certificate Type	Passport, Driving License, ID Card, and Others are available to choose from the drop-down list. If the ID Scan OCR function is activated, visitor information will display automatically after clicking  icon.
Certificate No.	The numbers and letters are legal; the max length is 20.
Category	Select the visitor category from the drop-down list.
Set Watch Time	You can set watch time for the selected visitor by clicking on the check box. Then enter the Start Date and end Date.
Rejection counts and Dates	Displays how many times the business rejected the visitor and rejected dates.

Table 10- 15 Description of WatchList Parameters

10.6.2.2 Delete WatchList

Operation Steps:

Step 1: In the **Visitor** module, click **Advanced > WatchList** and select the visitor watch list to be deleted.

Step 2: Click **Delete** to delete the selected watch list.

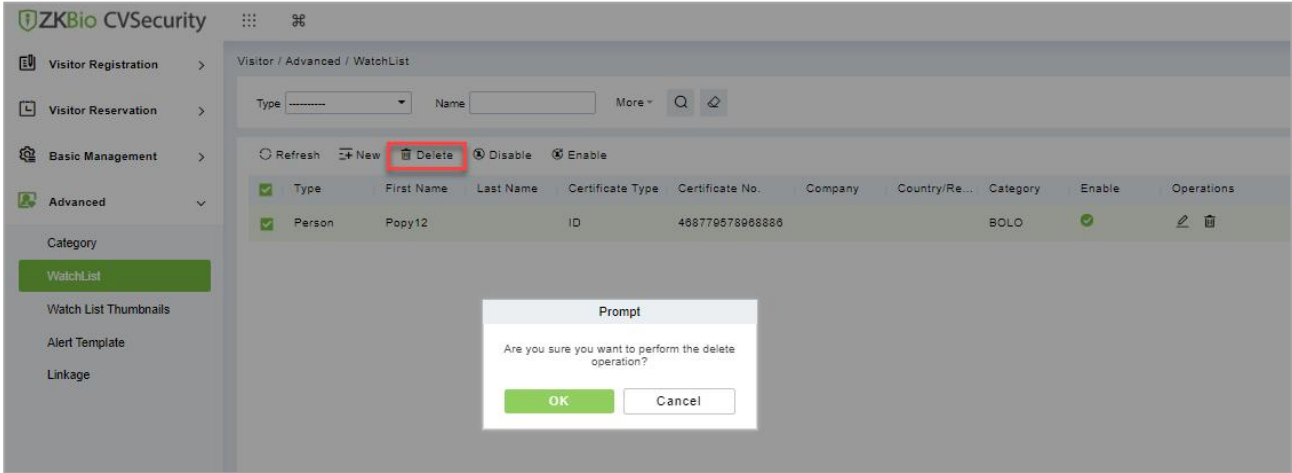

Figure 10- 78 To Delete WatchList

Step 3: Click **OK** to perform the delete operation.

10.6.2.3 Enable WatchList

In **Visitor** module Click **WatchList > Advance**, select a blocked visitor, and click **Enable**.

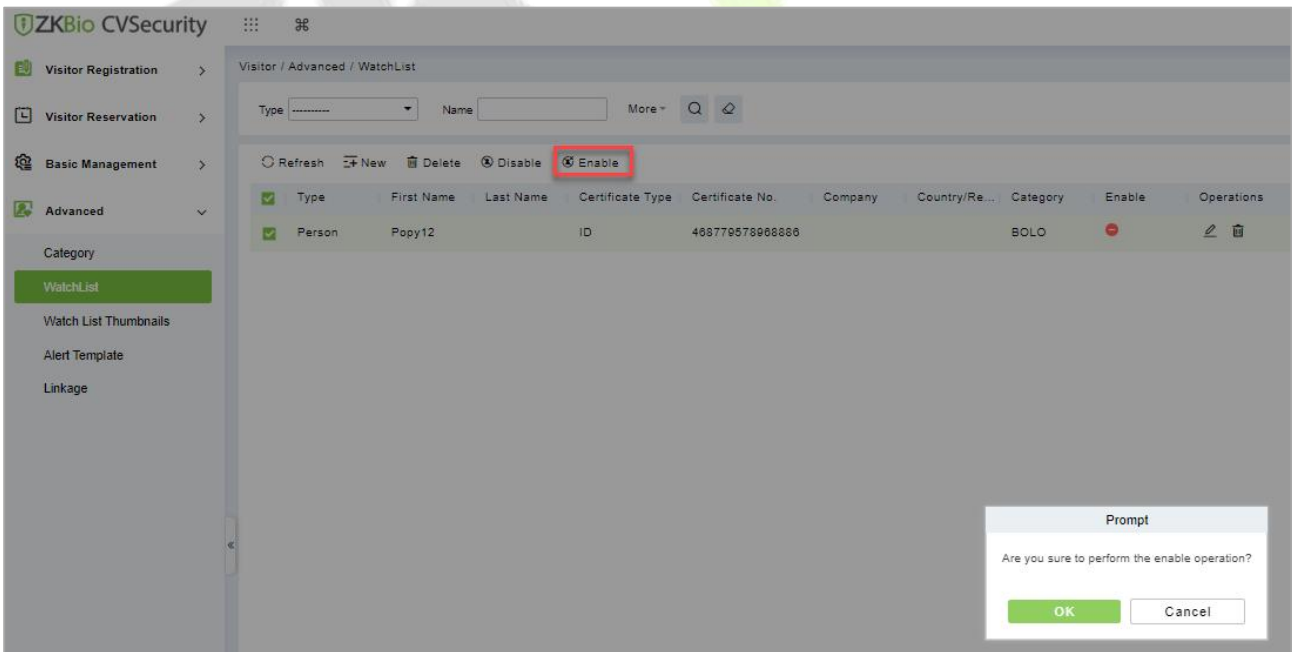



Figure 10- 79 Enabling WatchList

Click **OK** to enable the visitor. The enable entry for the corresponding selected visitor will show  indicates the visitor’s Watch list is enabled.

10.6.2.4 Disable WatchList

In **Visitor** module Click **WatchList > Advance**, select a visitor, and click **Disable**.

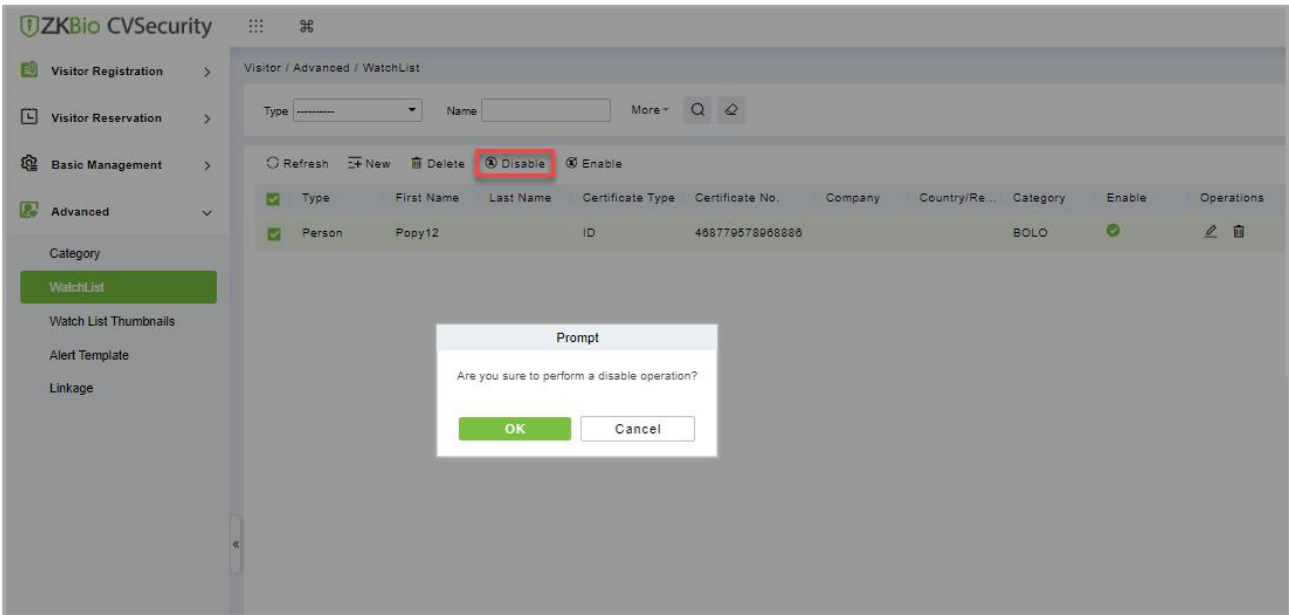



Figure 10- 80

Figure 10-75 Disabling WatchList

Click **OK** to block the visitor. The enable entry for the corresponding selected visitor will show  indicates the visitor’s Watch list is blocked.

10.6.3 Watch List Thumbnails

Displays the thumbnail of watchlist person’s image.

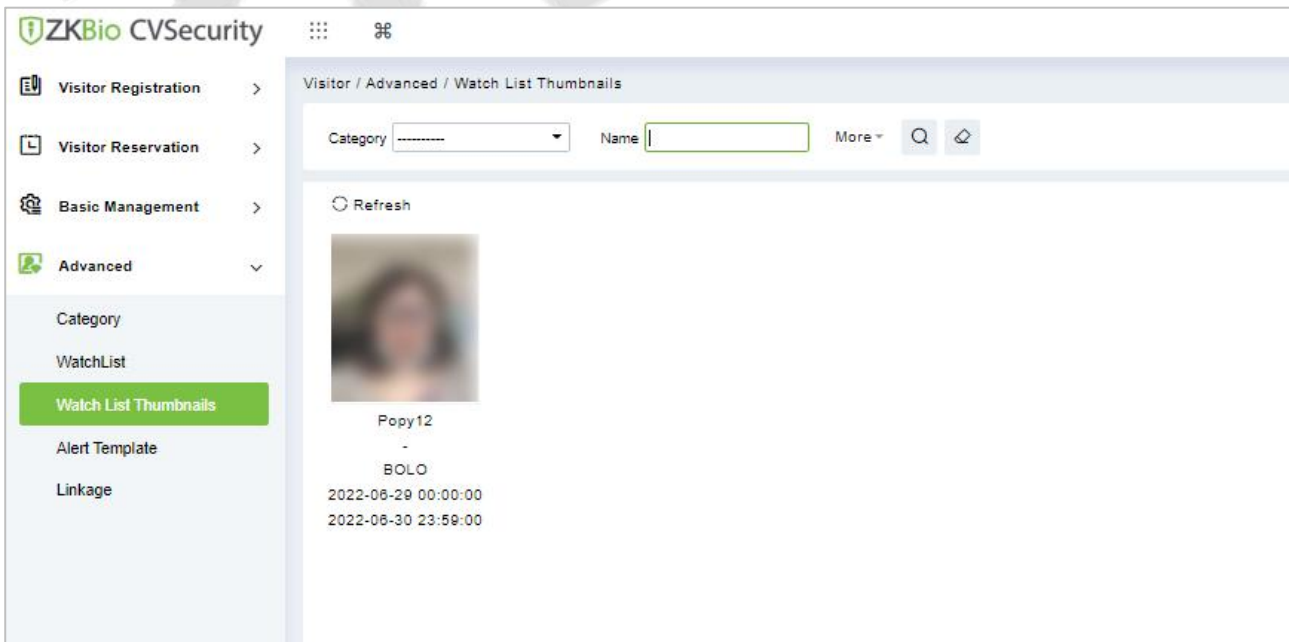

Figure 10- 81 WatchList Thumbnails Interface

10.6.4 Alert Template

This feature can add, edit the message templates. Different events have different template types. When a visitor reserved, checked in, checked out, reserved timeout, and visited timeout, the system will alert the visitor and the host via email or SMS.

10.6.4.1 To Add Alert Template (New)

Operation Steps:

Step 1: In the **Visitor** module, click **Advanced > Alert Template** and click **New** to add Alert Template.

Step 2: Enter the Details such as Template Name, Template Type, Event Type and Visitor Information.

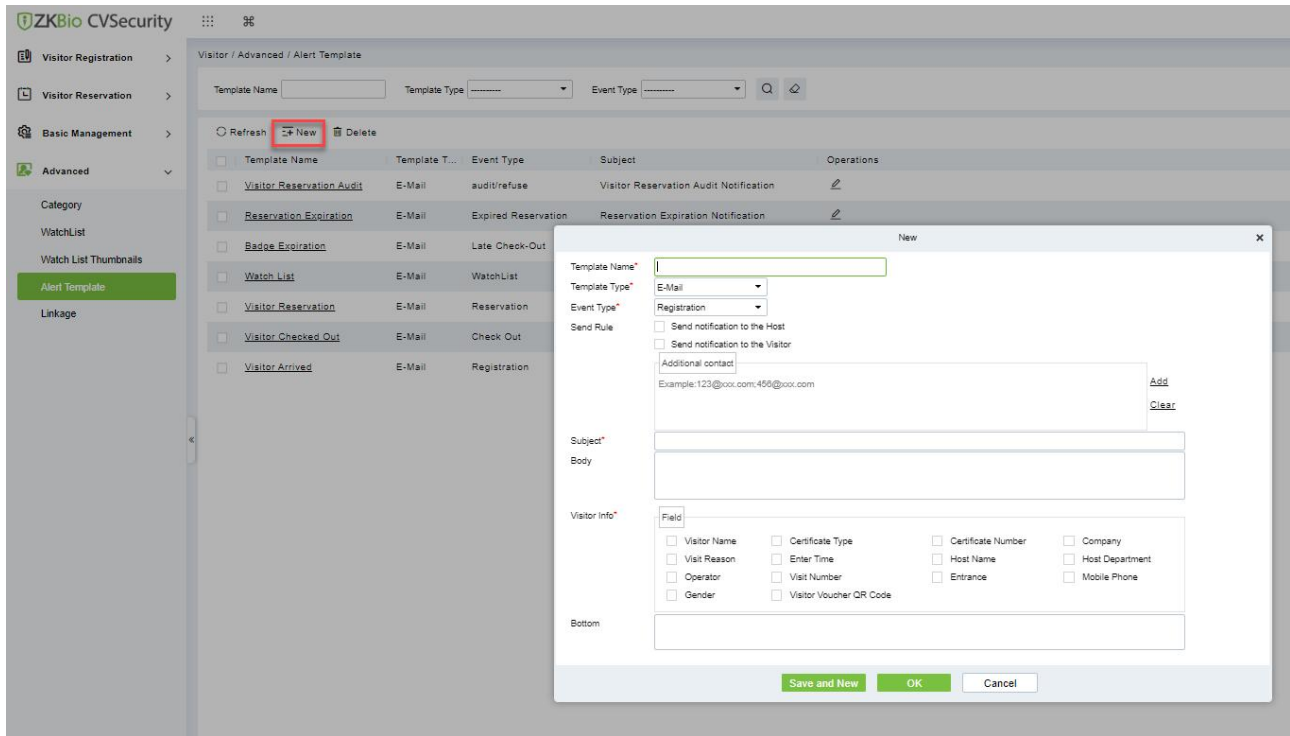

Figure 10- 82 Alert Template Interface

Step 3: Click **Save** and New to save the alert template.

Parameter	Description
Template Name	Enter the Template Name
Template Type	Select template type such as E-mail or SMS.
Event Type	Select the event type from the drop-down list such as Registration, Reservation, Check-out, Watch List etc.
Send Rule	You can set the send rule by clicking on check boxes. By using this option admin can send notification to the Host as well as visitor about the events (like Registration, Check Out Timing, etc.). Admin can add additional Email in Additional Contact column.
Subject And Body	Enter the template's subject and message to send to the host or visitor.
Visitor Info	Admin can add visitor information like Visitor Name, Visit Reason, Certificate Type etc. by clicking on the check boxes.

Table 10- 16 Description of Alert Template Parameters

10.6.4.2 Delete Alert Template

Operation Steps:

Step 1: In the **Visitor Module**, click **Advanced > Alert Template** and select the template to be deleted.

Step 2: Click **Delete** to delete the selected template.

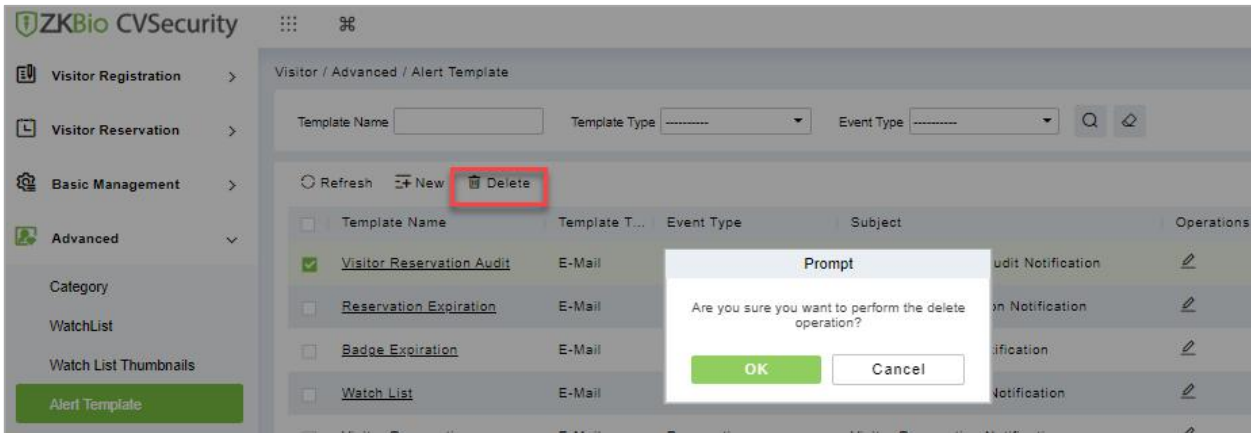

Figure 10- 83 To Delete Alert Template

Step 3: Click **OK** to perform the delete operation.

10.6.5 Linkage

This feature allows you to create a linkage function for each event. You can select the event, entrance and the Email template.

10.6.5.1 To Add Linkage

Operation Steps:

Step 1: In the **Visitor** module, click **Advanced > Linkage** and click **New** to add linkage.

Step 2: Enter Linkage name and select Entrance, SMS Template and E-mail Template.

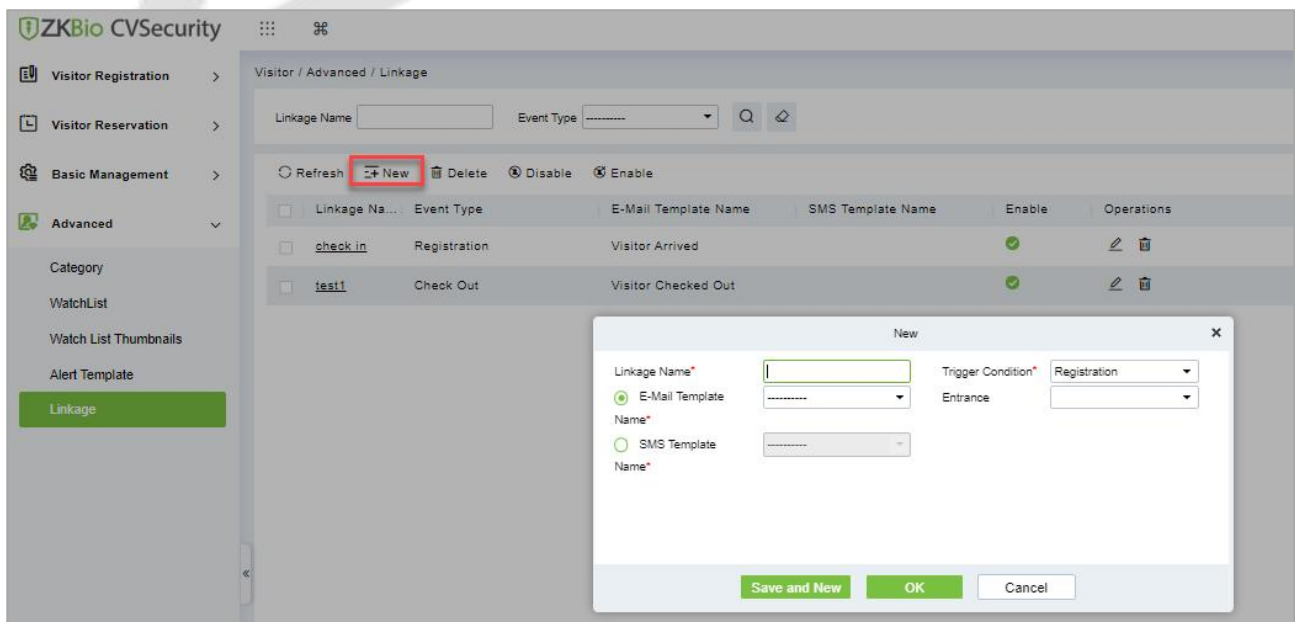

Figure 10- 84 Linkage Interface

Step 3: Click **Save and New** to save the details.

Parameter	Description
Linkage Name	Enter the Linkage Name.
Trigger Condition	Select trigger condition such as registration, reservation, check out etc.
Email Template	Select E-mail template from drop-down list.
SMS Template	Select SMS template from drop-down list.
Entrance	Select the Entry place.

Table 10- 17 Description of Linkage Parameters

10.6.5.2 Delete Linkage

Operation Steps:

Step 1: In the **Visitor** module, click **Advanced > Linkage** and select the linkage to be deleted.

Step 2: Click **Delete** to delete the selected linkage.

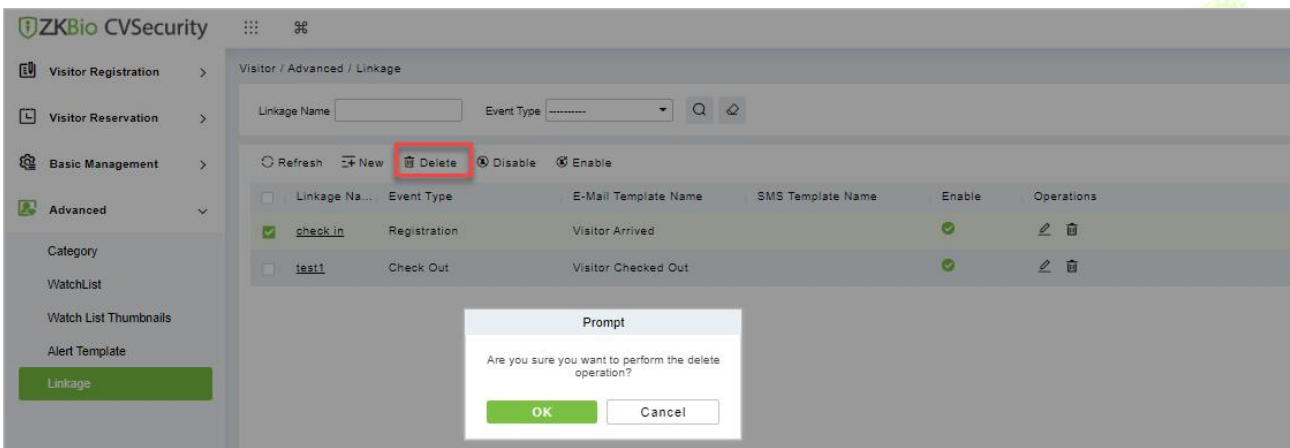

Figure 10- 85 To Delete Linkage

Step 3: Click **OK** to perform the delete operation.

10.6.5.3 Enable Linkage

In the **Visitor** module, click **Advanced > Linkage**, select a blocked Linkage to enable that, and click **Enable**.

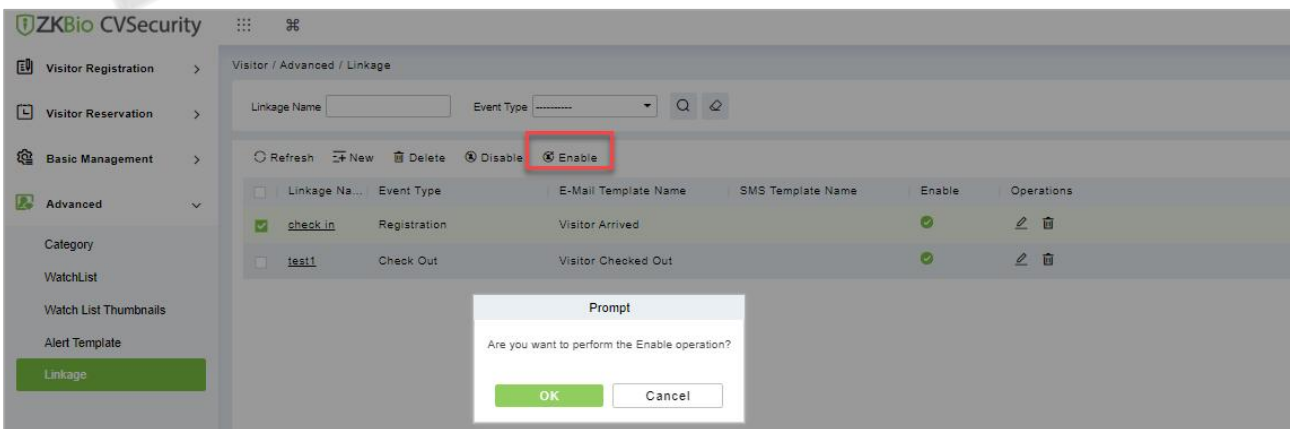



Figure 10- 86 Enabling Linkage

Click **OK** to enable the linkage. The enable entry for the corresponding selected linkage will show  indicates the linkage is enabled.

10.6.5.4 Disable Linkage

In the **Visitor** module, click **Advanced > Linkage**, select linkage to be disable, and click **Disable**.

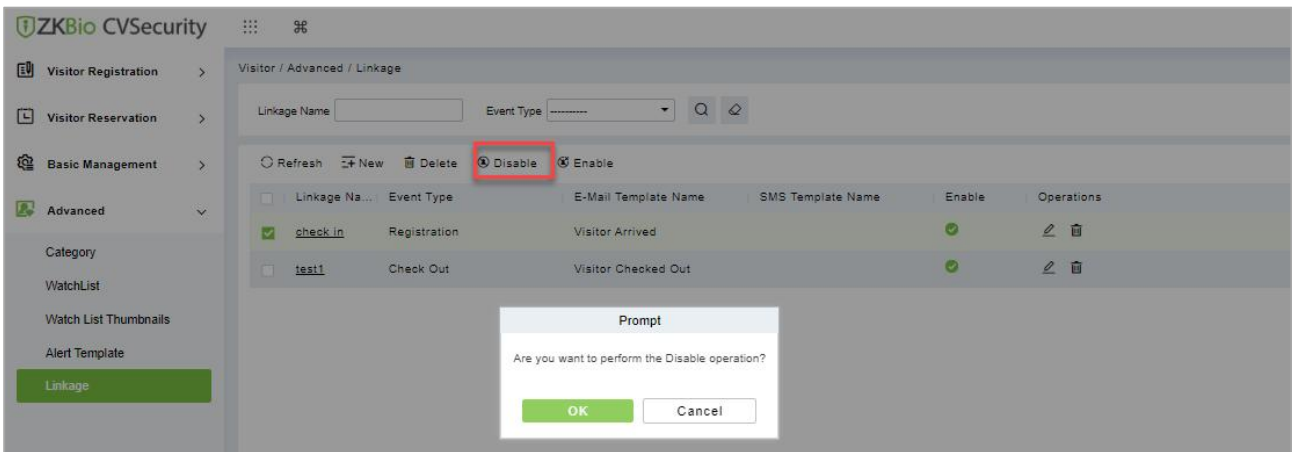



Figure 10- 87 Disabling Linkage

Click **OK** to block the linkage. The enable entry for the corresponding selected linkage will show  indicates the linkage is blocked.

10.7 Visitor Reports

10.7.1 Last Visited Location

In the **Visitor** module, click **Reports > Last Visited Location** to view the reports. The reports can be filtered by different conditions.

You can export the data into an Excel, PDF, or CSV file. See the following figure by clicking **Export** option.

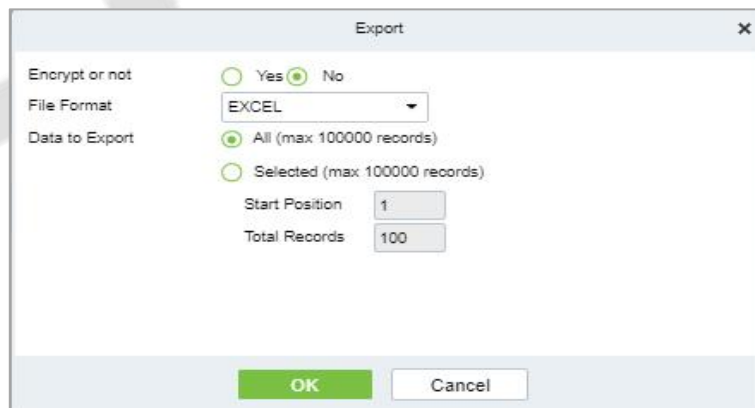

Figure 10- 88 Export Option

Select file format and data to be export, then click **OK**.

Last Visited Location										
Visitor Code	First Name	Last Name	Event Date	Enter Time	Event Point	Event Description	Reader Name	Verification Mode	Area	Stay Time
800000020	usuop	sss	2022-07-27 09:42:13	2022-07-27 09:41:24	10.10.20.73-1	Normal Verify Open	10.10.20.73-1-In	Only Pin	Area Name	00:00:48

Figure 10- 89 Last Visited Location Record

10.7.2 Visitor History Record

In the **Visitor Module**, click **Reports > Visitor History Record** to view the reports. The reports can be filtered by different conditions.

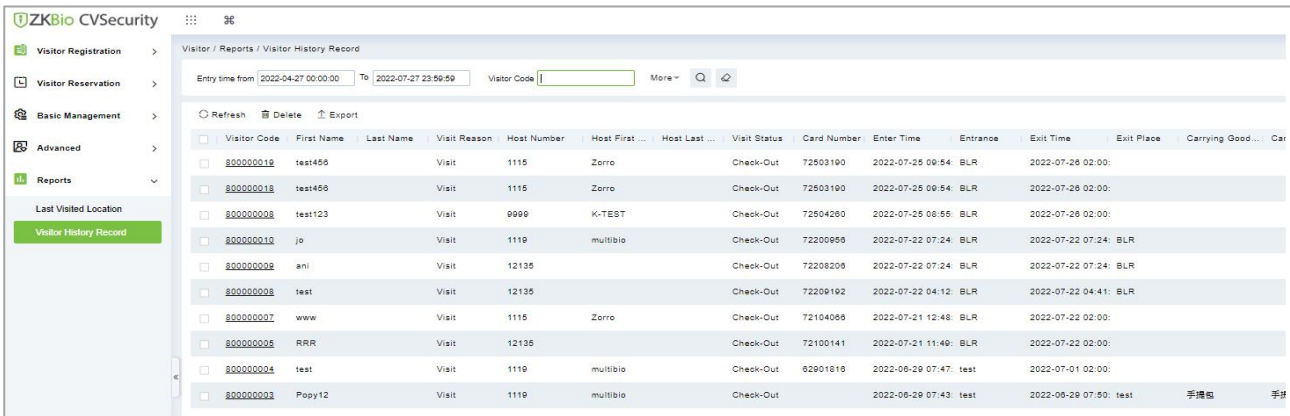

Figure 10- 90 Visitor History Record Interface

10.7.2.1 Export

You can export the records into an Excel, PDF, or CSV file. See the following figure by clicking **Export**.

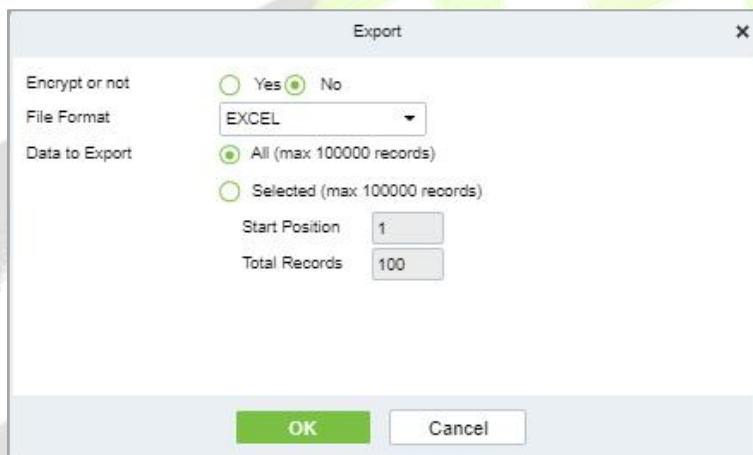

Figure 10- 91 Export Option

Select file format and data to be export, then click **OK**.

Visitor Code	First Name	Last Name	Visit Reason	Host Number	Host First Name	Host Last Name	Visit Status	Card Number	Enter Time	Entrance	Exit Time	Exit Place	Carrying Goods In	Carrying Goods Out	Remarks on health	City visited in past 14 days	Body Temperature (°C/°F)	Any symptoms in the last 14 days	Any exposure to suspected cases
80000019	test456		Visit	1115	Zorro		Check-Out	72503190	2022-07-25 09:54:03	BLR	2022-07-26 02:00:02								
80000018	test456		Visit	1115	Zorro		Check-Out	72503190	2022-07-25 09:54:01	BLR	2022-07-26 02:00:02								
80000008	test123		Visit	9999	K-TEST		Check-Out	72504260	2022-07-25 08:55:34	BLR	2022-07-26 02:00:02								
80000010	jo		Visit	1119	multibio		Check-Out	72200956	2022-07-22 07:24:36	BLR	2022-07-22 07:24:49	BLR							
80000009	ani		Visit	12135			Check-Out	72208206	2022-07-22 07:24:18	BLR	2022-07-22 07:24:49	BLR							
80000008	test		Visit	12135			Check-Out	72209192	2022-07-22 04:12:48	BLR	2022-07-22 04:41:36	BLR							

Figure 10- 92 Visitor History Record

10.7.2.2 Delete Visitor History

Operation Steps:

Step 1: In the **Visitor** module, click **Reports > Visitor History Record** and select the visitor's history to be deleted.

Step 2: Click **Delete** to delete the visitor history.

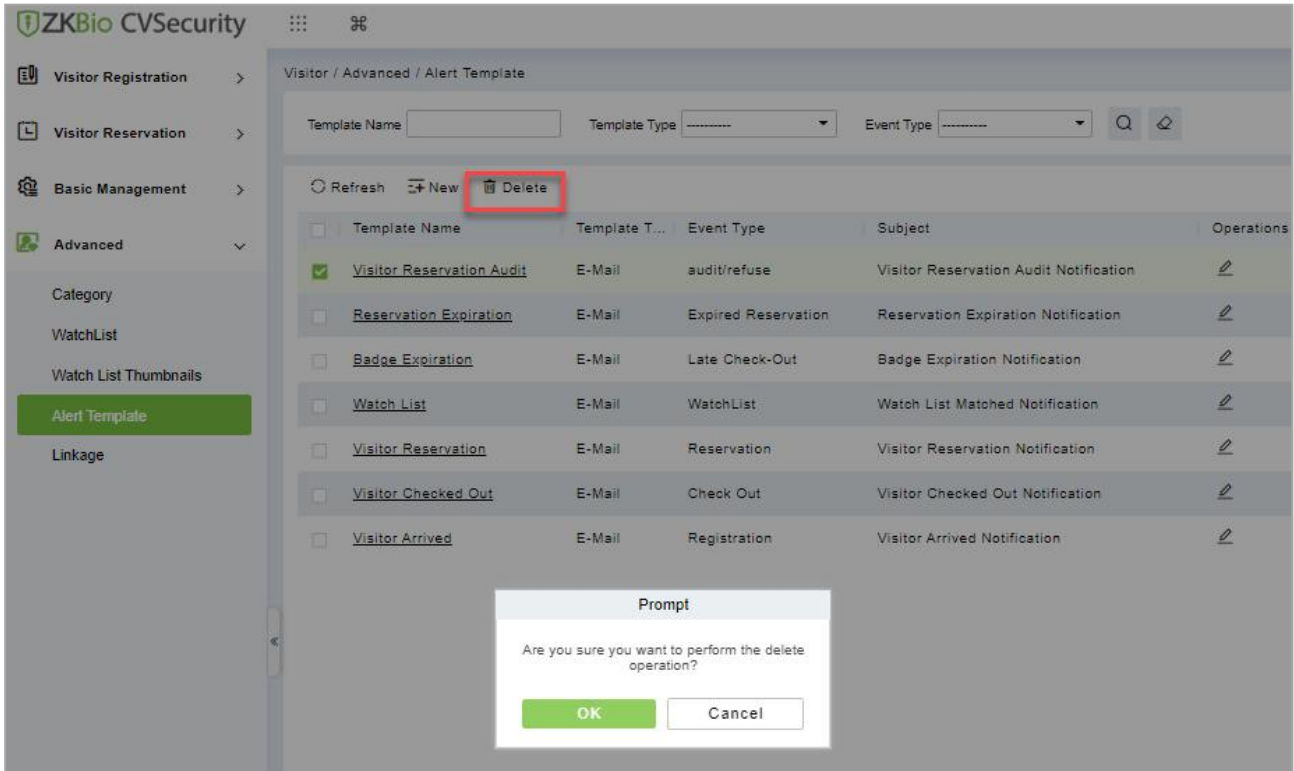

Figure 10- 93 To Delete Alert Template

Step 3: Click **OK** to perform the delete operation.

11 Patrol Management

11.1 Operation Scenario

Patrol management business can realize the effective supervision and management of patrol personnel, patrol plan and patrol route by enterprise managers, and at the same time, it can also make regular statistics and analysis on patrol route and results.

11.2 Operation Flow

Introduce the configuration process of patrol management.

The patrol management configuration process is shown in Figure 11-1.

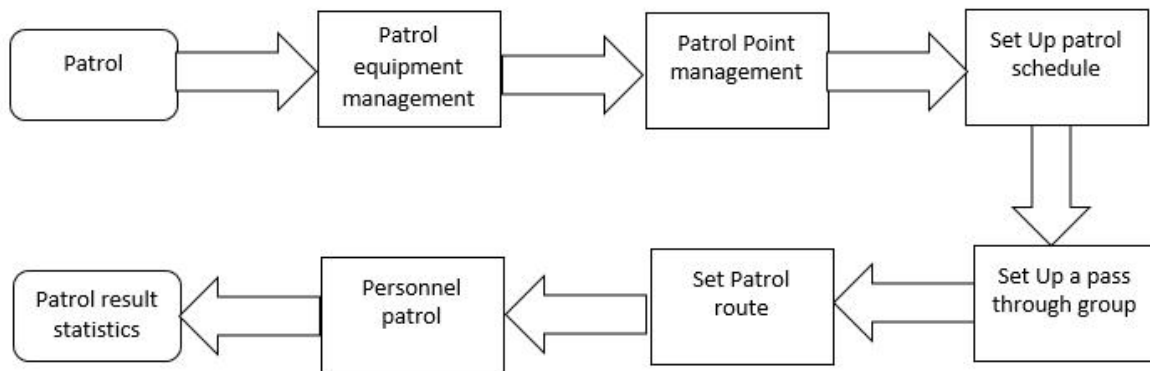

Figure 11-1 Patrol Configuration Flow

11.3 Patrol Route Monitoring

11.3.1 Patrol Monitoring

Displays all the scheduled routes in the patrol plan on the same day. When the patrol personnel patrol normally as planned, the patrol points in the corresponding patrol routes will turn green; If you don't patrol according to the rules, the patrol point will turn red. This interface is shown in the patrol monitoring interface, as shown in Figure 11-2. Refer to Table 11-1 for status description.

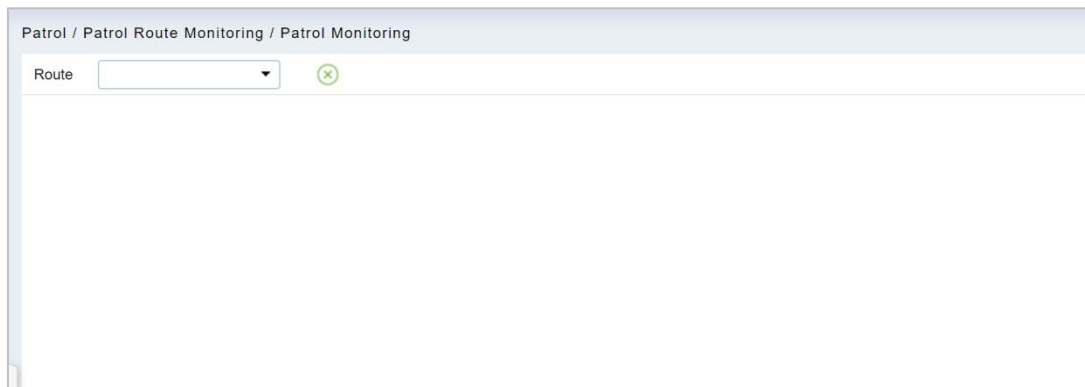

Figure 11-2 Patrol Monitoring



Parameter	Description
Normal Patrol	Personnel complete patrol in a normal time period according to normal sequence rules.
Wrong Patrol	The personnel completed the patrol within the normal time period but did not follow the regular route.
Leakage Patrol	The personnel did not complete the patrol within the normal time period, that is, one or part of the patrol points did not patrol.
Absence	Personnel has not completed the patrol within the normal time period, that is, the whole patrol route has not completed one patrol.
	The patrol route is wrong/missed.
	Normal patrol.
	Not patrolling.

Table 11-1 Patrol Status Description

11.4 Basic Settings (Patrol Basic Management)

11.4.1 Device Addition (Device)

11.4.1.1 Add device (New)

Select a device to be used as the patrol device from the access control devices. Click **Basic Management > Device > New**. In the **Alternative** box, add available devices and click **OK** to save the setting. The page is displayed as follows:

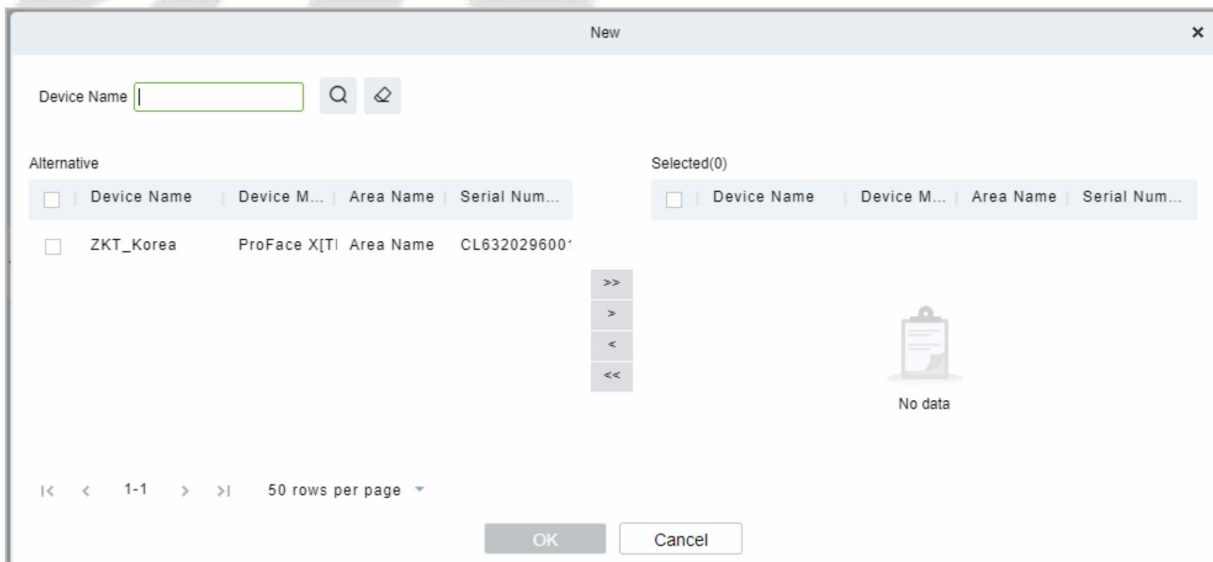

Figure 11-3 Add Device (New)

Precondition:

Before the patrol operation, it is necessary to add patrol device in the **Access Control** module and patrol personnel in the **Personnel** module.

Parameters	Instructions
Device Name	Customize the name of this device
Serial Number	Customize the device serial number.
Area Name	Divide the area for the device.
Device Model	Manufacturer of the device.

Table 11-2 Access Control

11.4.1.2 Delete

Select personnel in the list on the right and click **Delete** above the list to delete the personnel from the patrol group

11.4.1.3 Edit

Click a device name or Edit in the operation column to go to the Edit page. Make modifications and click OK to save modifications.

11.4.2 Checkpoint**11.4.2.1 Add Checkpoint (New)**

Step 1: Click **Basic Management > Checkpoint > New**. The page is displayed as follows:

Figure 11-4 New Checkpoint

Step 2: After the setting (parameters with * are mandatory), click **OK** to save the setting. You can also click **Save and New** to save the current setting and add another checkpoint. Click **Cancel** to cancel the setting and return to the upper-level menu.

Parameters	Description
Checkpoint	Unique name which can identify a route.
Device Module	Displays the device number.
Area Name	It can support typing anything alphabet but can't typing the common.
Device Name	Manufacturer of the device.
Patrol Tag	Currently, only access control readers are supported
Installation Position	Set a suitable name for the position. Any character, maximum combination of 100 characters. Position names should not be repeated.
Operations	The patrol operation, it is necessary to add patrol device in the Access Control module.

Table 11-3 New Checkpoint

11.4.2.2 Delete

Select personnel in the list on the right and click **Delete** above the list to delete the personnel from the checkpoint

11.4.2.3 Edit

Click a device name or **Edit** in the operation column to go to the Edit page. Make modifications and click **OK** to save modifications.

Note: Patrol tags that have been used by checkpoints cannot be used again when you add another checkpoint.

11.4.3 Parameters

Step 1: Click **Patrol > Basic Management > Parameters**.

Step 2: Set the interval for patrol statistics collection.

Step3: Click **OK** to save the setting.

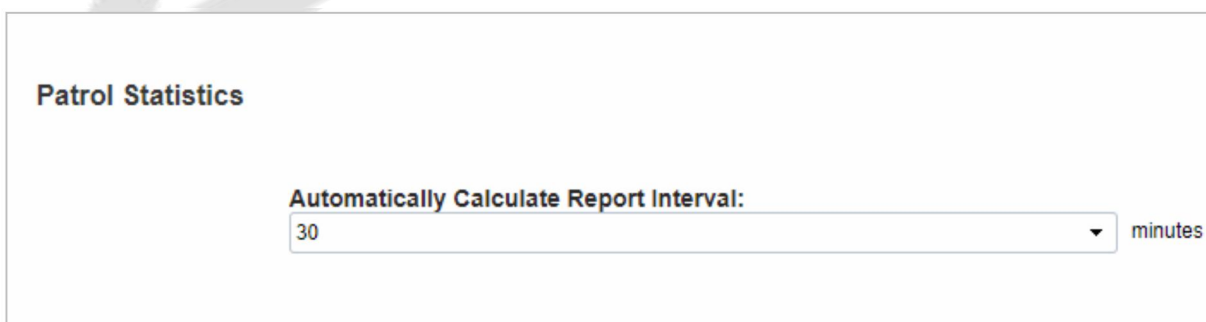

Figure 11-5 Parameters

11.5 Patrol Management

11.5.1 Set Up a Patrol Plan

11.5.1.1 Add Plan (New)

Operating Steps:

Step 1: In the **Patrol** module, select "**Patrol Management > Patrol Plan**" and click **New**.

Step 2: In the **New** window that pops up, configure the patrol plan information, as shown in Figure 11-6, and describe the key parameters as shown in Table 11-1.

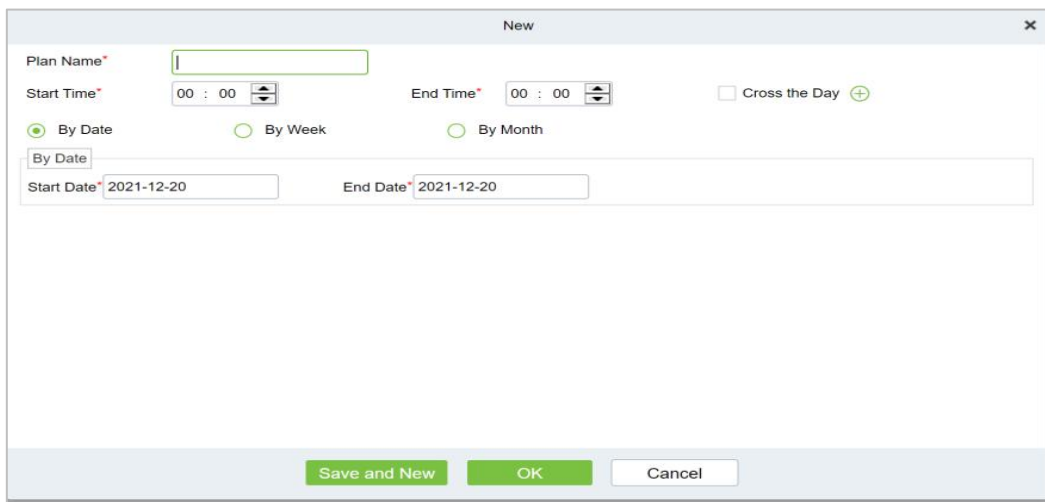

Figure 11-6 Patrol Plan

Parameter	Instructions
Time Period	You can set the time to be set in a day, or you can set it across days.
By Date	The patrol plan is scheduled daily. Check by Date to set the start date and end date of the patrol plan.
By Week	The patrol plan is scheduled on a weekly basis.
By Month	The patrol plan is scheduled monthly. There are two ways to implement the monthly plan: daily implementation or regular implementation. Choose the patrol plan to perform the patrol task every day in the selected month; If you choose to perform regularly, you will perform the patrol task within the specified date in the month.

Table 11-4 Parameter Setting Description

Step 3: Click **OK**.

Parameter	Instructions
Plan Name	Customize the Plan Name.
Cycle Type	Customize the Cycle Type.
Plan	A maximum of three patrol shifts can be added for a patrol plan.
Time Zone	This abnormal event is triggered if a user with the floor opening right punches his/her card beyond the effective periods

Operations	The patrol operation, it is necessary to add patrol device in the Access Control module.
------------	---

Table 11-5 Parameter Setting

11.5.2 Designated Patrol Personnel Group (Patrol Group)

11.5.2.1 Add Patrol Group (New)

Operating Steps:

Step 1: In the **Patrol** module, select "**Patrol Management > Patrol Group**" and click **New**.

Step 2: In the pop-up **New** window, configure the patrol personnel group information, as shown in Figure 11-5.

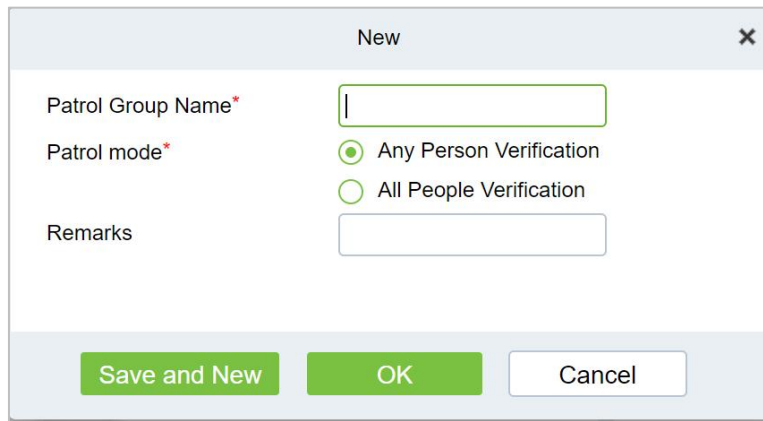

Figure 11-7 Patrol Personnel Group

Step 3: Click **OK**.

Step 4: Under the operation of the patrol group interface, click "**Add Personnel**".

Step 5: In the **Add Person** window that pops up, configure the person information, as shown in Figure 11-8.

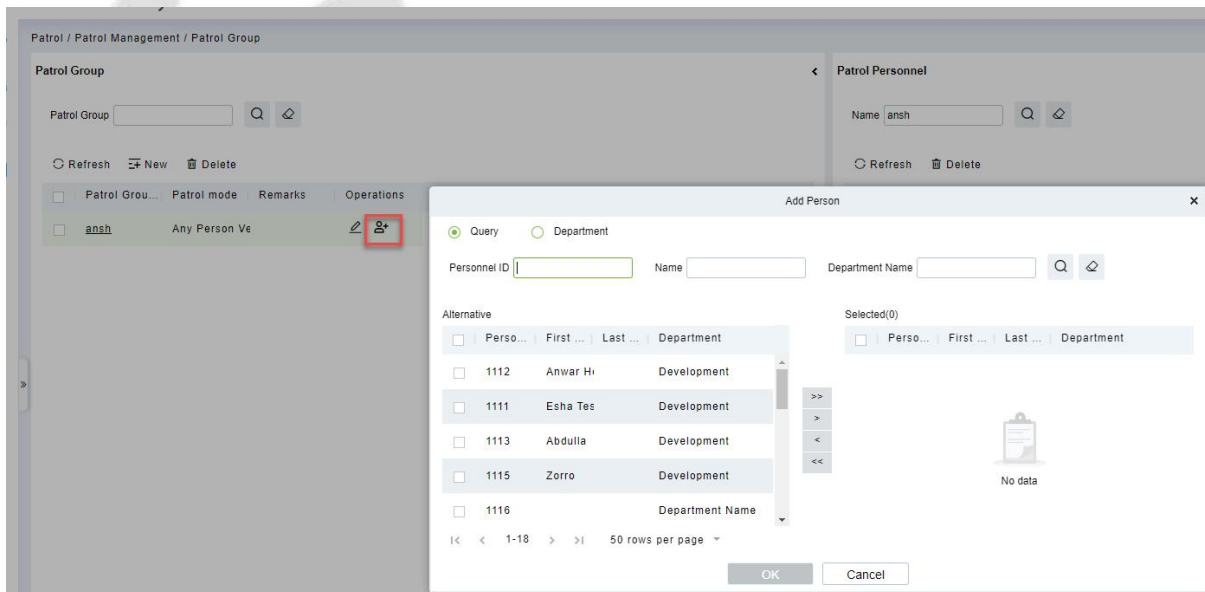

Figure 11-8 Adding Patrol Team Personnel

Step 6: Click **OK**.

11.5.2.2 Delete

Select personnel in the list on the right and click **Delete** above the list to delete the personnel from the patrol group.

Parameters	Instructions
Patrol Group	Click a patrol group from the list on the left. Personnel in the patrol group are displayed in the list on the right.
Patrol Mode	A patrol group cannot be edited or deleted when it is used by a patrol route.
Remarks	Custom Setting Notes Description.
Operations	The patrol operation, it is necessary to add patrol device in the Access Control module.
Personnel ID	Click Add Personnel under Operation in the list on the left. The page for adding personnel is displayed (or adding by department). Add personnel to the list on the right and click OK to finish the setting.
First Name/ Last Name	The maximum length cannot exceed 50, does not support comma; value sources Personnel field, cannot add, modify, delete.
Department Name	Select from the pull-down menu and click OK . If the department was not set previously, only one department named Company Name will appear.

Table 11-6 Delete Personnel

11.5.3 Set Up Patrol Routes (Route)

11.5.3.1 Add Route (New)

Operating Steps:

Step 1: In the **Patrol** module, select "**Patrol Management > Patrol Route**" and click **Add**.

Step 2: In the pop-up **Add** window, configure the patrol route information as shown in Figure 11-9 and Figure 11-10, and describe the key parameters as shown in Table 11-7.

The screenshot shows a 'New' dialog box with the following fields and controls:

- Route Name***: A text input field.
- Plan Name***: A dropdown menu.
- Limited Time***: A text input field with '0' and the unit 'minutes'.
- Deviation***: A text input field with '0' and the unit 'minutes'.
- Patrol Subject***: A dropdown menu with 'Select patrol personnel' and a checkbox for 'Patrol Group'.
- Buttons**: 'Next Step' (highlighted in green) and 'Cancel'.

Figure 11-9 The First Step of The Patrol Route

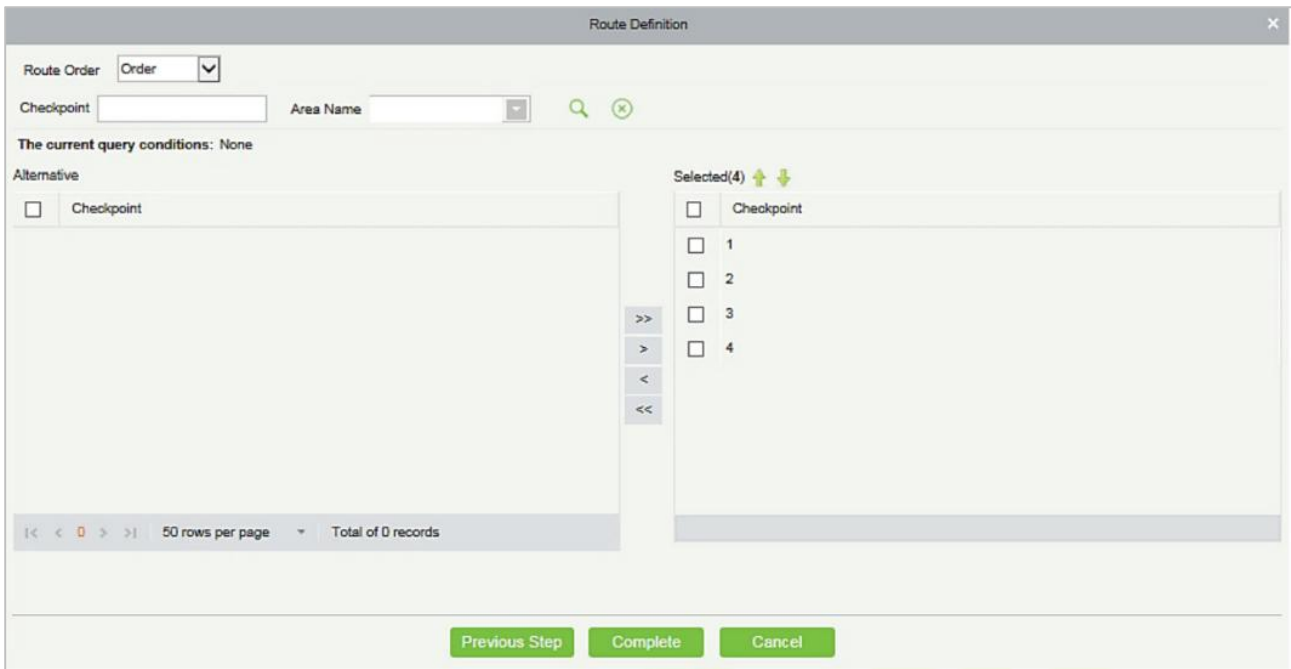

Figure 11-10 The Second Step of The Patrol Route

Parameters	Instructions
Route Name	Customize the Route Name.
Plan Name	Customize the plan Name.
Patrol Subject	Select the patrol personnel.
Checkpoint Order	In the patrol route, all checkpoints are 2 types of order and disorder routes.
Limited Time	Set up the desired Limited Time.
Deviation	Set up the required Deviation Time.
Route Status	Displays the route status.
Sort Type	Fill in the number of the superior department.
Operations	The patrol operation, it is necessary to add patrol route in the Access Control module.

Table 11-7 Second Step of Patrol Route

11.5.3.2 Delete

Select personnel in the list on the right and click **Delete** above the list to delete the personnel from the patrol route.

11.5.3.3 Enable/ Disable

Select device, click **Enable/Disable** to stop/start using the device. When communication between the device and the system is interrupted or device fails, the device may automatically appear in disabled status. After adjusting local network or device, click **Enable** to reconnect the device and restore device communication.

Parameter	How to set
Error	Allowable error time setting for patrol. Assuming that the patrol plan is not 9:00-12:00, and the allowable error time is 5 minutes before and after, then the records in the period of 8:55-12:05 are valid records, and those beyond the above range

Parameter	How to set
	are invalid records, which will not be counted. As long as the patrol is not within the above time range, it is invalid.
Orderly Route	When carrying out the patrol plan, there is no time limit between the patrol points, and the patrol personnel can complete the patrol work of each patrol point in sequence according to their own habits within the limited time of the route.
Unordered Route	<ul style="list-style-type: none"> Complete disorder: There is no order in all patrol points of the patrol route, and the patrol personnel can complete the patrol work of each patrol point within the total time limit according to their own habits. Disorder outside the first point: in the patrol route, other patrol points except the designated patrol starting point are disordered. Disorder outside the tail point: in the patrol route, other patrol points except for the last patrol point of the designated patrol route are disordered. Disorder outside the beginning and end points: In the patrol route, except for the first and last patrol points in the designated patrol route, other patrol points are out of order.

Table 11-8 Parameter Setting Description

Step 3: Click **OK**.

11.6 Result Validation(Patrol Reports)

In the patrol report, you can query the "All Records", "Patrol Records Today's", "Patrol Route Statistics" and "Patrol Personnel Statistics" report. You can choose to export all or export records after querying.

This paper introduces the configuration Steps of report query and export, taking the "all records" report operation as an example.

11.6.1 All transactions

Click **Reports > All transactions** to view all transactions, that is, all event records generated by the patrol device.

You can export all transactions into an Excel, PDF, or CSV file. See the following figure.

Operating Steps:

Step 1: In the **Patrol** module, select **Report > All Records**.

Step 2: In the All Records interface, fill in the corresponding query information and click the **Query** symbol to complete the query of all record tables, as shown in Figure 11-11.

Figure 11-11 All Records

Step 3: In the full record interface, click **Export**, enter the user password in the pop-up security verification, and click **OK**. Select whether to encrypt and export the file format, and Click **OK**, as shown in Figure 11-12.

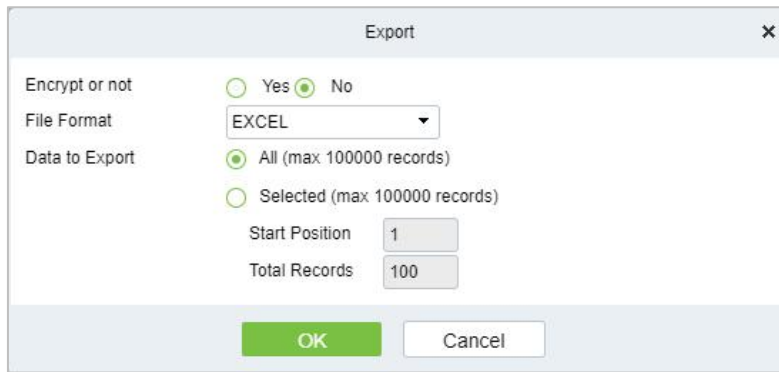

Figure 11-12 Report Export Interface

Step 4: After selecting the address where the corresponding file is stored, the export of the file can be completed.

ZKTECO											
All Transactions											
Time: 2017-09-15 00 : 00 - 2017-12-15 23 : 59 : 59											
Time	Device Name	Personnel ID	First Name	Last Name	Card Number	Device Module	Route Name	Checkpoint	Verification Mode	Area Name	Remark
2017-12-15 13:53:51	192.168.218.80	8	Glori	Liu	6189166	Access	Route1	checkpoint1	Only Card	Area Name	
2017-12-15 13:53:51	192.168.218.80	8	Glori	Liu	6189166	Access	Route1	checkpoint2	Only Card	Area Name	
2017-12-15 13:53:49	192.168.218.80	8	Glori	Liu	6189166	Access	Route1	checkpoint2	Only Card	Area Name	
2017-12-15 13:53:48	192.168.218.80	8	Glori	Liu	6189166	Access	Route1	checkpoint1	Only Card	Area Name	
2017-12-15 13:53:46	192.168.218.80	7	Jacky	Xiang	6323994	Access	Route1	checkpoint2	Only Card	Area Name	
2017-12-15 13:53:46	192.168.218.80	7	Jacky	Xiang	6323994	Access	Route1	checkpoint1	Only Card	Area Name	
2017-12-15 11:54:18	192.168.218.80	8	Glori	Liu	6189166	Access	route1	checkpoint1	Only Card	Area Name	
2017-12-15 11:54:17	192.168.218.80	8	Glori	Liu	6189166	Access	route1	checkpoint2	Only Card	Area Name	
2017-12-15 11:54:15	192.168.218.80	7	Jacky	Xiang	6323994	Access	route1	checkpoint2	Only Card	Area Name	
2017-12-15 11:54:14	192.168.218.80	7	Jacky	Xiang	6323994	Access	route1	checkpoint1	Only Card	Area Name	
2017-12-15 11:54:10	192.168.218.80	5	Necol	Ye	13280079	Access	route1	checkpoint2	Only Card	Area Name	
2017-12-15 11:54:10	192.168.218.80	5	Necol	Ye	13280079	Access	route1	checkpoint1	Only Card	Area Name	
2017-12-15 11:54:08	192.168.218.80	2	Lucky	Tan	6155266	Access	route1	checkpoint1	Only Card	Area Name	
2017-12-15 11:54:07	192.168.218.80	2	Lucky	Tan	6155266	Access	route1	checkpoint2	Only Card	Area Name	
2017-12-15 11:53:49	192.168.218.80	2	Lucky	Tan	6155266	Access	route1	checkpoint1	Only Card	Area Name	
2017-12-15 11:53:47	192.168.218.80	2	Lucky	Tan	6155266	Access	route1	checkpoint2	Only Card	Area Name	
2017-12-15 11:53:44	192.168.218.80	2	Lucky	Tan	6155266	Access	route1	checkpoint1	Only Card	Area Name	
2017-12-15 11:53:42	192.168.218.80	2	Lucky	Tan	6155266	Access	route1	checkpoint2	Only Card	Area Name	

Created on: 2017-12-15 18:45:34
Generated from ZKBioSecurity software. All rights reserved.

Figure 11-13 Report Export File

Parameters	Instructions
Time	Set the start and end time in each time interval. Time period includes one week and three holiday-type time intervals.
Personnel ID	Displays the Personnel ID number.
Device Name	Manufacturer of the device.
Name	Select the desired name.
Route Name	Displays the Route name.
Verification Mode	You can set verification mode as following options: Automatic Recognition, Fingerprint, PIN, Password, Card, Fingerprint/ Password, Fingerprint/Card, PIN+Fingerprint, Fingerprint+Password etc.
Card Number	The max length is 10, and it should not be repeated.
Checkpoint	Displays the Type of checkpoint.
Area Name	Customize the Area name.

Table 11-9 Report Export File

11.6.2 Patrol Records Today

Click **Reports > Patrol Records Today** to view event records generated by the patrol device today.

You can export patrol records today into an Excel, PDF, or CSV file. See the following figure.

ZKTECO Patrol Records Today											
Time	Device Name	Personnel ID	First Name	Last Name	Card Number	Device Module	Route Name	Checkpoint	Verification Mode	Area Name	Remark
2017-12-15 13:53:51	192.168.218.60	8	Glori	Liu	6189106	Access	Route1	checkpoint1	Only Card	Area Name	
2017-12-15 13:53:51	192.168.218.60	8	Glori	Liu	6189106	Access	Route1	checkpoint2	Only Card	Area Name	
2017-12-15 13:53:49	192.168.218.60	8	Glori	Liu	6189106	Access	Route1	checkpoint2	Only Card	Area Name	
2017-12-15 13:53:48	192.168.218.60	8	Glori	Liu	6189106	Access	Route1	checkpoint1	Only Card	Area Name	
2017-12-15 13:53:46	192.168.218.60	7	Jacky	Xiang	6323994	Access	Route1	checkpoint2	Only Card	Area Name	
2017-12-15 13:53:46	192.168.218.60	7	Jacky	Xiang	6323994	Access	Route1	checkpoint1	Only Card	Area Name	
2017-12-15 11:54:18	192.168.218.60	8	Glori	Liu	6189106	Access	route1	checkpoint1	Only Card	Area Name	
2017-12-15 11:54:17	192.168.218.60	8	Glori	Liu	6189106	Access	route1	checkpoint2	Only Card	Area Name	
2017-12-15 11:54:15	192.168.218.60	7	Jacky	Xiang	6323994	Access	route1	checkpoint2	Only Card	Area Name	
2017-12-15 11:54:14	192.168.218.60	7	Jacky	Xiang	6323994	Access	route1	checkpoint1	Only Card	Area Name	
2017-12-15 11:54:10	192.168.218.60	5	Necol	Ye	13260079	Access	route1	checkpoint2	Only Card	Area Name	
2017-12-15 11:54:10	192.168.218.60	5	Necol	Ye	13260079	Access	route1	checkpoint1	Only Card	Area Name	
2017-12-15 11:54:08	192.168.218.60	2	Lucky	Tan	6155266	Access	route1	checkpoint1	Only Card	Area Name	
2017-12-15 11:54:07	192.168.218.60	2	Lucky	Tan	6155266	Access	route1	checkpoint2	Only Card	Area Name	
2017-12-15 11:53:48	192.168.218.60	2	Lucky	Tan	6155266	Access	route1	checkpoint1	Only Card	Area Name	
2017-12-15 11:53:47	192.168.218.60	2	Lucky	Tan	6155266	Access	route1	checkpoint2	Only Card	Area Name	
2017-12-15 11:53:44	192.168.218.60	2	Lucky	Tan	6155266	Access	route1	checkpoint1	Only Card	Area Name	
2017-12-15 11:53:43	192.168.218.60	2	Lucky	Tan	6155266	Access	route1	checkpoint2	Only Card	Area Name	

Created on: 2017-12-15 18:45:48
Created from ZKBioSecurity software. All rights reserved.

Figure 11-14 Patrol Records Today

Parameters	Description
Personnel ID	Displays the Personnel ID number.
Card Number	Displays the Card Number.
Name	Select the required Name.
Device	Manufacturer of the device.
Verification Mode	Displays the Automatic Recognition, Fingerprint, PIN, Password, Card, Fingerprint/Password, Fingerprint/Card, PIN+Fingerprint, Fingerprint+Password etc.
Route Name	Displays the Route name.
Checkpoint	Displays the Type of checkpoint.
Area Name	Customize the Area name.
Time	Set the start and end time in each time interval. Time period includes one week and three holiday type time intervals.
Remarks	Custom Setting Notes Description.

Table 11-10 Patrol Record Today

11.6.3 Patrol Route Statistics

Click **Reports > Patrol Route Statistics** to view all normal and abnormal situations collected during the patrol process.

You can export patrol route statistics into an Excel, PDF, or CSV file. See the following figure.

ZKTECO Patrol Route Statistics								
Route Name	Plan Name	Statistics time	Supposed Patrol Times	Real patrol times	Missed patrol times	Wrong patrol number	Absence times	Patrol Subject
route1	plan1	2017-12-15 13:30:00	2	2	0	0	0	Amber Lin,Necol Ye,Jacky Xiang, Glori Liu,Lilian Mei, Jerry Wang,Berry Cao,Lucky Tan, Sherry Yang,Leo Hou.
Route1	plan1	2017-12-15 16:00:00	2	2	0	1	0	Lucky Tan,Jerry Wang,Necol Ye, Leo Hou,Sherry Yang,Lilian Mei, Berry Cao,Amber Lin,Jacky Xiang, Glori Liu.

Figure 11-15 Patrol Route Statistics

Parameters	Description
Route Name	Displays the required route name.
Plan Name	Displays the type of plan name.
Statistics time	Displays the Time and date of patrol route statistics.
Supposed Patrol Times	Number of times that the patrol personnel should normally patrol.
Real Patrol Times	Number of times that the patrol personnel patrol
Wrong Patrol Times	Number of times that the patrol personnel do not patrol based on the patrol route.
Missed Patrol Times	Number of times that the patrol personnel miss one or more checkpoints in the patrol route within the patrol time.
Absence Times	Number of times that the patrol personnel do not patrol.

Table 11-11 Patrol Route Statistics

11.6.4 Patrol Personnel Statistics

Click **Reports > Patrol Personnel Statistics** to view patrol statistics of patrol personnel.

You can export patrol personnel statistics into an Excel file. See the following figure.

Patrol Personnel Statistics									
Personnel ID	Person Name	Route Name	Plan Name	Statistics time	Supposed Patrol Times	Real patrol times	Missed patrol times	Wrong patrol number	Absence times
4	Berry Cao	route1	plan1	2017-12-15 13:30:00	2	2	0	0	0
3	Leo Hou	route1	plan1	2017-12-15 13:30:00	2	2	0	0	0
8	Glori Liu	route1	plan1	2017-12-15 13:30:00	2	2	0	0	0
2940	Sherry Yang	route1	plan1	2017-12-15 13:30:00	2	2	0	0	0
6	Amber Lin	route1	plan1	2017-12-15 13:30:00	2	2	0	0	0
5	Necol Ye	route1	plan1	2017-12-15 13:30:00	2	2	0	0	0
7	Jacky Xiang	route1	plan1	2017-12-15 13:30:00	2	2	0	0	0

Figure 11-16 Patrol Personnel Statistics

Parameters	Description
Supposed Patrol Times	Number of times that the patrol personnel should normally patrol.
Real Patrol Times	Number of times that the patrol personnel patrol
Wrong Patrol Times	Number of times that the patrol personnel do not patrol based on the patrol route.
Missed Patrol Times	Number of times that the patrol personnel miss one or more checkpoints in the patrol route within the patrol time.
Absence Times	Number of times that the patrol personnel do not patrol.

Table 11-12 Patrol Personnel Statistics

ZKTECO

12 Entrance Control

12.1 Operation Scenario

This system connects the gate control board through channel Device (such as TDA integrated machine), and directly controls the relevant parameters of the gate through software, thus controlling the entry and exit of the gate and realizing the automatic management of the gate.

12.2 Operation Flow

Introduce the configuration process of channel service.

The channel business configuration process is shown in Figure 12-1.

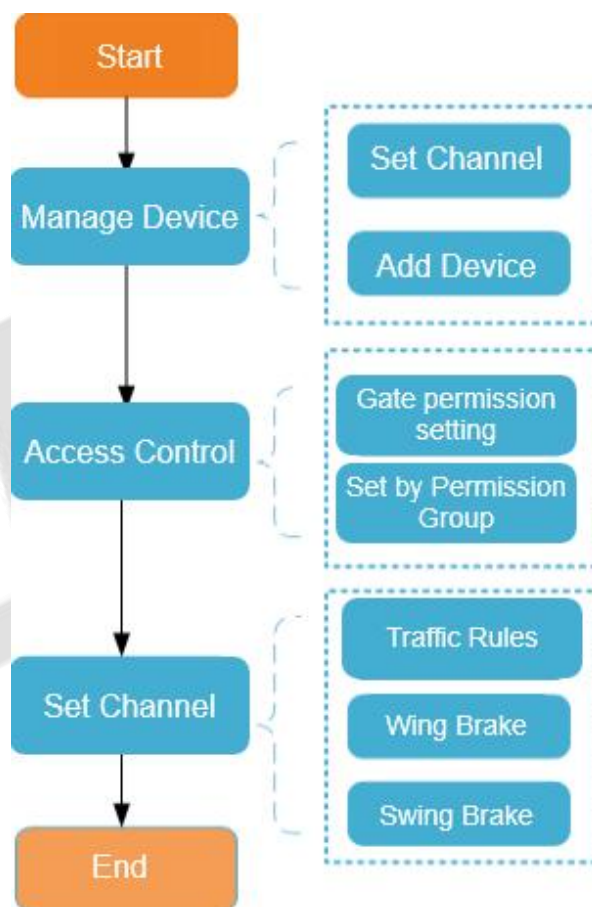

Figure 12-1 Channel Configuration Flow

12.3 Channel Device

Add channel integrated machine Device, and the integrated machine communicates with the gate control board through RS485 to control the gate

12.3.1 Passage

Setting the area to which the channel belongs is convenient for users to manage the channel Device in a specific area. After setting the channel, the Device under the channel can be filtered according to the area during real-time monitoring.

This paper introduces the Steps of creating and configuring channels in ZKBio CVSecurity.

12.3.1.1 To Add Passage (New)

Operating Steps:

Step 1: In the **Entrance Control** module, select **Channel Device > Passage**.

Step 2: In the channel interface, click **New** and fill in the relevant parameters, as shown in Figure 12-2. Please refer to Table 12-1 for parameter description.

Figure 12-2 New Channel Interface

Parameter	How to set
Passage Name	Any character, a combination of up to 20 characters, cannot be repeated.
Rank	Only numbers are supported, up to six digits, and repeatable. The smaller the ranking, in real-time monitoring, the display will move forward.
Area Name	Select the region to which the channel belongs.
Remarks	Any character with a maximum character length of 100.

Table 12-1 Description of New Channel Parameters

Step 3: Click **OK** to complete the channel setting.

12.3.1.2 Delete Passage

Operation Steps:

Step 1: In the **Entrance Control** module, select **Channel Device > Passage** and select the template to be deleted.

Step 2: Click **Delete** to delete the selected template Click **OK** to perform the delete operation

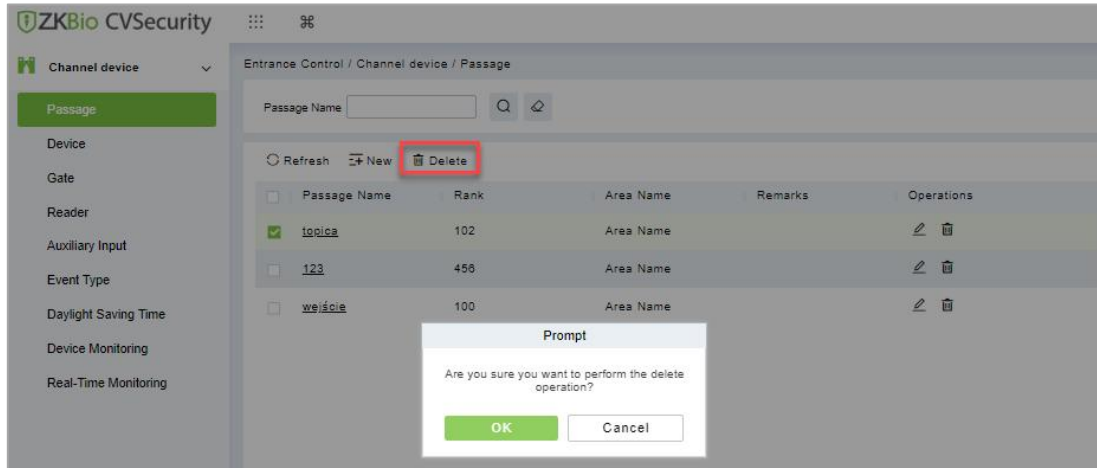

Figure 12-3 To Delete Passage

12.3.2 Device

12.3.2.1 Searching for Additional Channel Devices (Search)

Introduces the configuration Steps of searching for additional channel devices in ZKBio CVSecurity.

Precondition:

1. Set up IP allocation before adding channel devices.
2. Before searching and adding the device, it is necessary to set the address pointing to the server in advance and set the IP address and port of the current server, that is, the IP address and port installed by the current.

Operating Steps:

Step 1: In the **Entrance Control** module, select **Channel Device > Devices**.

Step 2: In the device interface, click "**Search**" to pop up the search box.

Step 3: Click **Search** in the search box to display the channel devices that can be added, as shown in Figure 12-4.

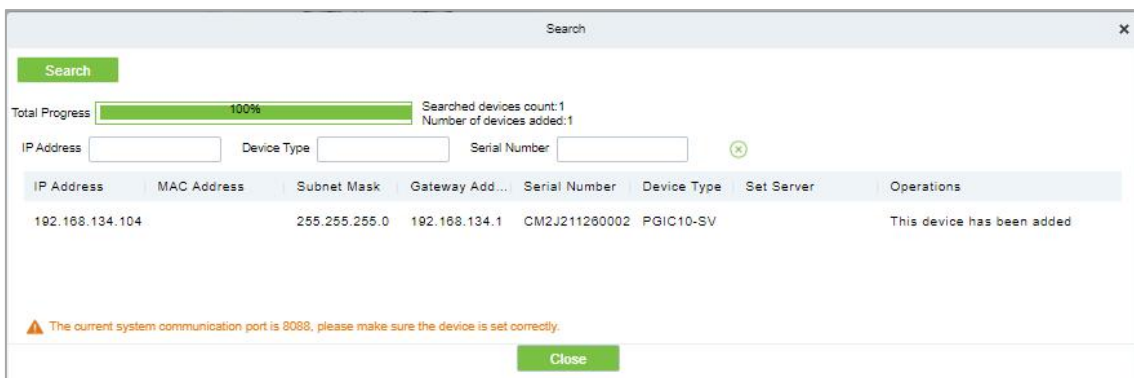

Figure 12-4 Device Search Interface

Step 4: For the channel Device found, click the **Add** button in the operation bar to **Add** the device, and fill in the parameters of device addition, as shown in Figure 12-5. Please refer to Table 12-2 for parameter description.



Figure 12-5 Device Addition Interface

Parameter	Description
Device Name	Any character, a combination of up to 20 characters, cannot be repeated.
Channel	Select the channel to which the device belongs.
Add to Permission Group	Automatically adds the device to the selected permission group.
Delete Data in Device When Adding	When the device is added, the data in the device except the event record is deleted.

Table 12-2 Description of Device Addition Parameters

Step 5: Click **OK** to complete the addition of channel device.

12.3.2.2 Delete

Operation Steps:

Step 1: In the **Entrance Control**, click **Channel Device > Device** and select device to be deleted.

Step 2: Click **Delete** to delete the device.

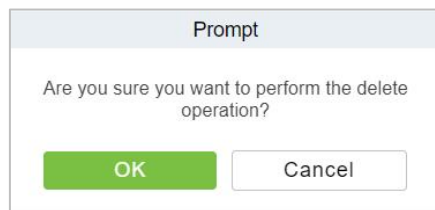

Figure 12-6 Delete Device

Step 3: Click **OK** to perform the delete operation.

12.3.2.3 Control

In this option admin can upgrade firmware and LCD screen firmware. Also, this option helps to reboot the device, enable and disable the devices, and synchronize time and all data.

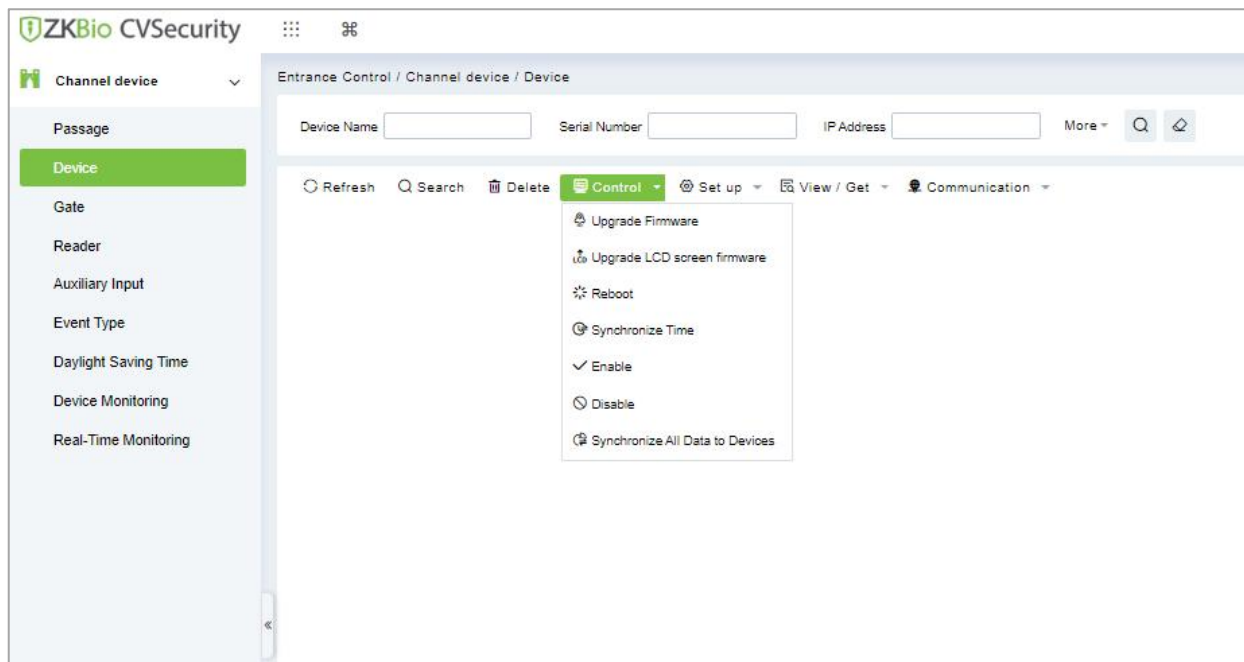

Figure 12-7 Device Control Interface

- **Upgrade Firmware**

Select the device to be upgraded and click **Upgrade Firmware** to open the setting page. Click **Browse**, select the firmware upgrade file (file name is emfw.cfg). Click **Start** to start upgrading the firmware.

Notes:

Please be cautious while upgrading the firmware. If the firmware has not been updated properly, it may lead to device failure. If you have any queries, please contact the representative or pre-sales technical support team.

- **Upgrade LCD Screen Firmware**

Admin can upgrade LCD screen firmware of device using this option. Select the device to be upgraded and click **Upgrade LCD Screen Firmware** to open the settings page. Click **Browse** and select the firmware upgrade file. Click **Start** to start upgrading the firmware.

- **Reboot the Device**

Admin can send a restart command to the device to automatically restart. Select the device to be reboot and click **Reboot** to restart the device.

- **Synchronize Time**

When the device's time is not accurate, select the device to be synchronized and then click **Synchronize Time** to synchronize the server time to the device.

- **Disable/Enable**

Select the device and click **Disable/Enable** to stop/start using the device. When communication between the device and the system is interrupted or there is a problem with the device, the device may be automatically displayed as disabled. After adjusting the network or device, click **Enable**. The system reconnects to the device, and the communication status of the device is restored.

- **Synchronize All Data to Devices**

This option synchronizes the data in the system to the device. Select the device, click **Synchronize All Data to Devices**, and click the **Synchronize** button to synchronize data:

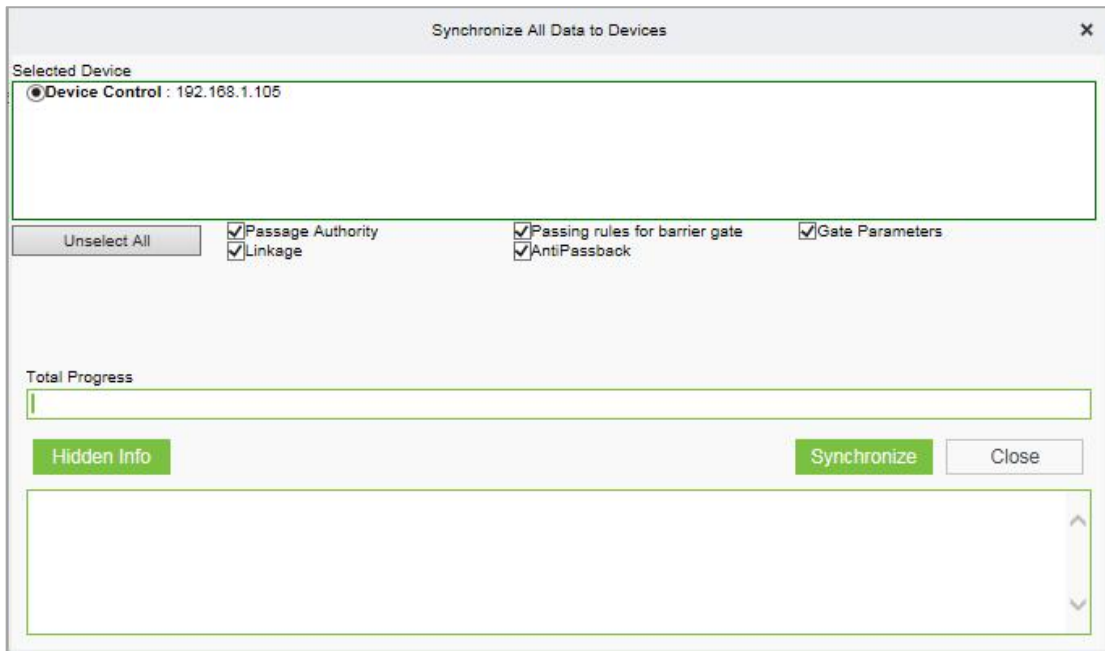

Figure 12-8 Synchronize All Data to Devices Interface

Notes:

The operation of synchronizing all data will first delete the existing data in the device (excluding event records) and then download all the setting information again. When performing this operation, please try to ensure that the network is unblocked and avoid power failure. When the device is running normally, please use this operation with caution. It is recommended to synchronize the data when the device is unused.

12.3.2.4 Set up

In this interface help you to set the time zone, registration, daylight saving time, fingerprint identification information and LCD screen display of the selected device.

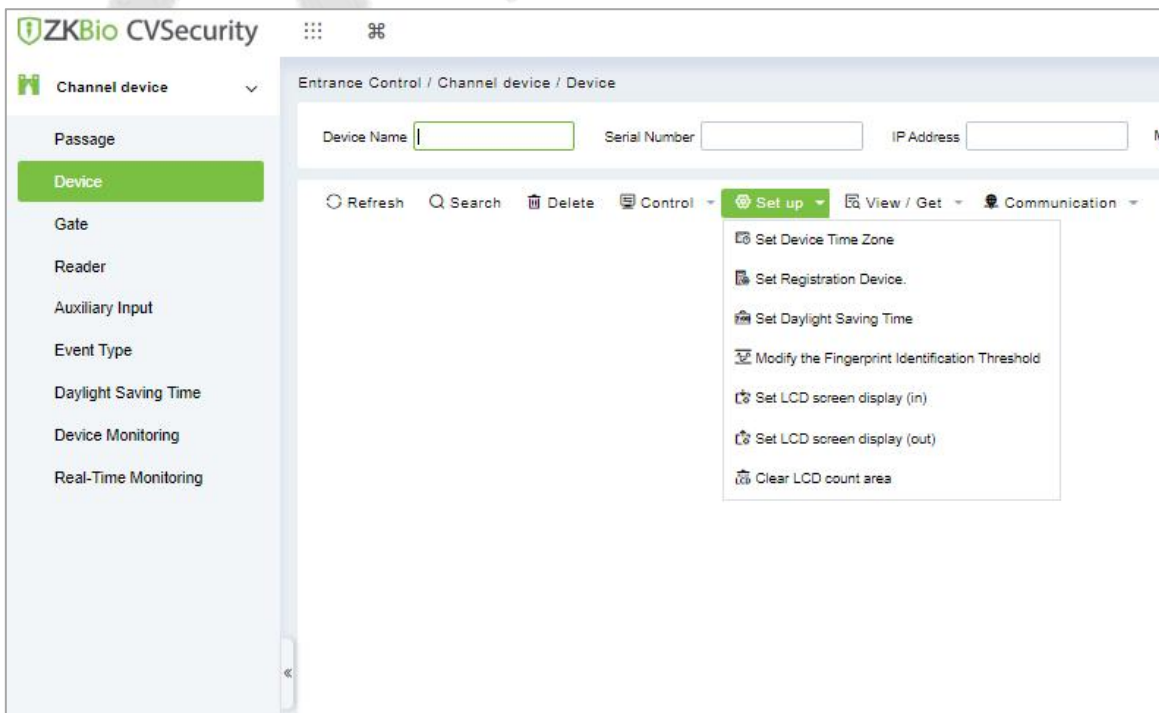

Figure 12-9 Set up Options

- **Set Device Time Zone**

Set Device Time Zone allows you to set the accurate time zone, if device shows wrong time zone. For that in **Entrance Control** interface, click **Channel Device > Device > Set-up**, select the device to be set up. Then click **Set Device Time Zone** to set up the selected device.

- **Set Registration Device**

The passage standalone device can only automatically upload the personnel and other data entered by the device when the registration device is set. For that in **Entrance Control** interface, click **Channel Device > Device > Set-up**, select the device to be set up. Then click **Set Registration Device** to set up the selected device.

- **Set Daylight Saving Time**

DST, also called the Daylight-Saving Time, is a system to adjusting the official prescribe local time to save energy. To meet the DST requirement, a special function can be customized. You may adjust the clock one hour forward at XX (hour) XX (day) XX (month) and one hour backward at XX (hour) XX (day) XX (month) if necessary.

In the **Entrance Control** interface, click **Channel Device > Device > Set-up** and select the device to be set Daylight Saving Time. Then click **Set Daylight Saving Time** to set up the selected device.

- **Modify the Fingerprint Identification Threshold**

The user can modify the fingerprint comparison threshold in the device, ranging from 35 to 70, and the factory default value is 55. When a new device is added, the system will read the value from the device, and the user can view the current fingerprint comparison threshold size through the device list (Please make sure the device supports the fingerprint function).

In the **Entrance Control** interface, click **Channel Device > Device > Set-up** and select the device to be modify the fingerprint identification. Then click **Modify the Fingerprint Identification Threshold** to set up the selected device.



Figure 12-10 Modify the finger Identification Option

- **Set LCD Screen Display (In)/(Out)**

Select the device and set the LCD screen display (in/out). The upper part is the video area 30%, the middle part is the gate channel display area 30%, and the lower part is the picture cycle 40%. Each area can be corresponding to the video and background, The image browsing and clearing operations are confirmed and sent to the LCD screen of the controller for display.

In the **Entrance Control** interface, click **Channel Device > Device > Set-up** and select the device to be set LCD screen display. Then click **Set LCD Screen Display (In)/(Out)** to set up the selected device.

- **Clear the LCD Counting Area**

Select the device, clear the middle counting area of the LCD screen, and restart counting.

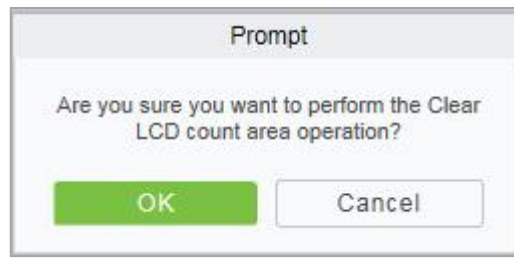

Figure 12-11 Clear LCD Counting Area

In the Entrance Control interface, click **Channel Device > Device > Set-up** and select the device to clear the LCD counting area. Then click **Clear the LCD Counting Area** to clear counting area the selected device.

12.3.2.5 View/ Get

In this interface admin can view device options, personal information and transaction details

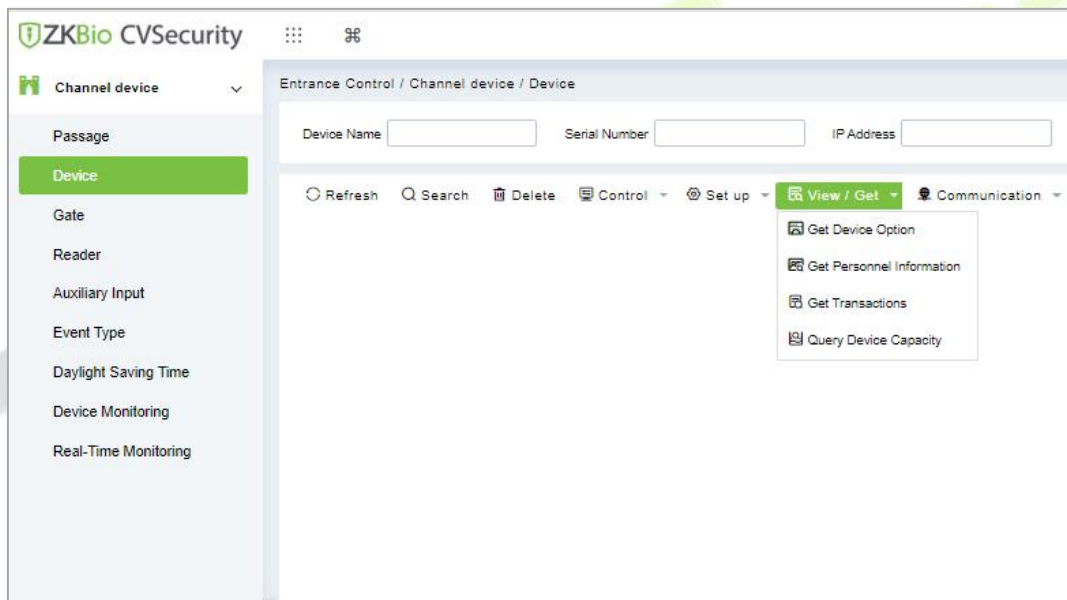

Figure 12-12 View/Get Option

- **Get Device Option**

This option allows you to view the common parameters of the device. For example, get the firmware version after the device is updated.

In the **Entrance Control** interface, click **Channel Device > Device > View/Get** and select the device to view device options. Then select **Get Device Option** to view device options.

- **Get Personnel Information**

This function obtains the data of Persons, Fingerprints, and Palmprints in the device or obtains the corresponding number.

In the **Entrance Control** interface, click **Channel Device > Device > View/Get** and select the device to view personnel information. Then select **Get Personnel Information** to view personnel information.

- **Get Transaction**

This function obtains the event records in the device to the system, and the user can choose to obtain new records or all the records.

In the **Entrance Control** interface, click **Channel Device > Device > View/Get** and select the device to get transaction. Then select **Get Transaction** to view transaction information.

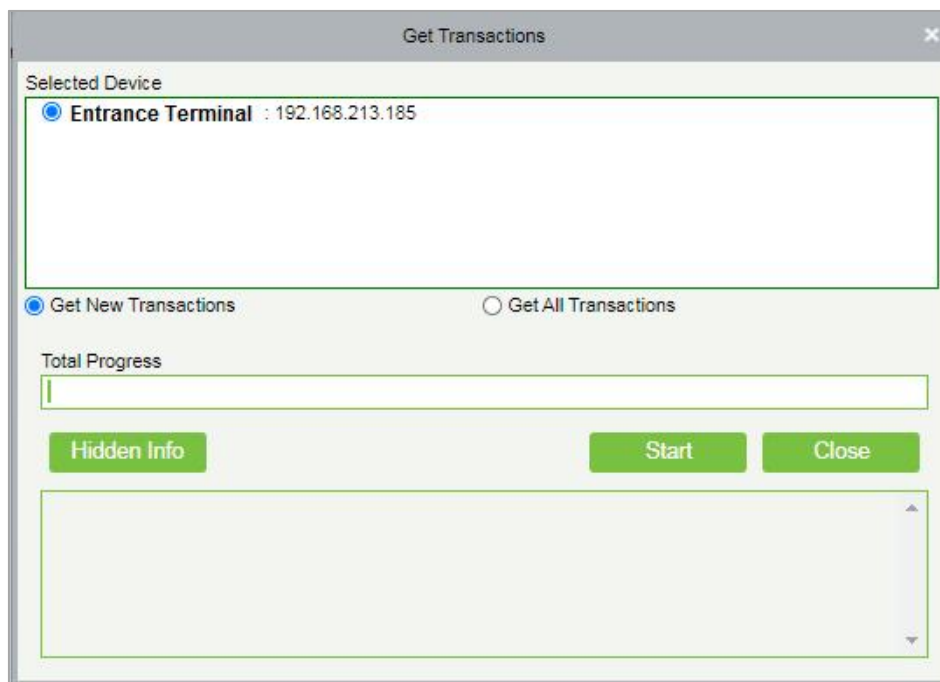

Figure 12-13 Get Transactions

When the network is in good condition and the communication between the system and the device is normal, the system will obtain the event record in the device in real-time and saves it in the database. When the communication is interrupted, the event record in the device is not uploaded to the system in real-time. At this time, the user can perform this operation to manually obtain the event records in the device.

- **Query Device Capacity**

Here, the user can view the capacity information of the device in the software and manually obtain the usage information (person, fingerprint, finger vein, face, palmprint) in the device. When the user finds that the information obtained from the software and the device is inconsistent, the user can manually synchronize the data.

In the **Entrance Control** interface, click **Channel Device > Device > View/Get** and select the device to view the capacity information of the device. Then select **Query Device Capacity** to view the user can view the capacity information of the device in the software and manually obtain the usage information.

12.3.2.6 Communication

In the **Entrance Control** interface, click **Channel Device > Device > Communication** to modify IP address and communication password.

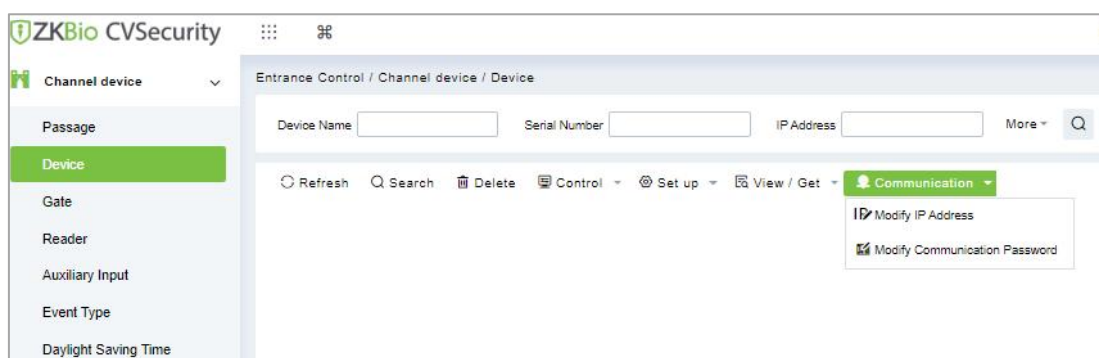

Figure 12-14 Communication Option

● Modify IP Address

Select a device and click **Modify IP address** to open the modification interface. It will obtain a real-time network gateway and subnet mask from the device. (Failed to do so, you cannot modify the IP address). Then enter a new IP address, gateway, and subnet mask. Click **OK** to save and quit. This function is the similar as Modify IP Address Function in Device.

● Modify Communication Password

Select a device and click **Modify Communication Password** to open the modification interface The system will ask for the old communication password before modifying it. After verification, input the new password twice, and click **OK** to modify the communication password.

Note: Communication passwords shouldn't contain spaces; it is recommended to use a combination of numbers and letters. Communication password settings can improve the device's security. It is recommended to set communication passwords for each device.

12.3.3 Gate

In the **Entrance Control** module, select **Channel Device > Gate**.

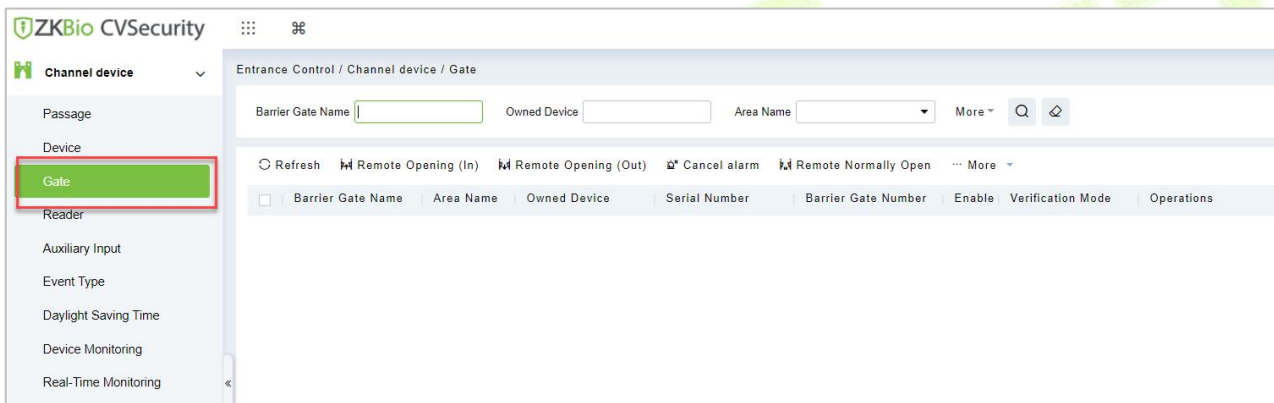

Figure 12-15 Channel Device Gate

12.3.3.1 Remote Gate Opening (in)/(out)

In the **Entrance Control** interface, click **Channel Device > Gate** interface allows the user to control one gate or all gates. To control a single gate right-click over it and click **Remote Opening (In/Out)** in the pop-up dialog box. To control all gates, directly click **Remote Opening (In/Out)** behind Current All.

12.3.3.2 Cancel the Alarm

Once an alarm door is displayed on the interface, the alarm sound will be played. Alarm cancellation can be done for a single gate or all gates.

In the **Entrance Control** interface, click **Channel Device > Gate** and select the alarm gate to be modified. Then click **Cancel the Alarm** to cancel the alarm.

Note: If **Cancel the Alarm** fails, check if any devices are disconnected. If found disconnected, check the network.

12.3.3.3 Remote Normally Open

It will set the gate as normal open by remote.

In the **Entrance Control** interface, click **Channel Device > Gate** and select the gate to be set as normal open. Then click **Remote Normal Open** to set the gate as normal open by remote.

12.3.3.4 More Options

In the **Entrance Control** interface, click **Channel Device > Gate > More** to activate the door lockdown status (remote lock and unlock).

- **Remote Lock:**

It will remotely set the door status to locked status. After this, the door wouldn't receive any operations, such as card reading and remote operations. This function is supported only by certain devices.

- **Remote Unlock:**

It will unlock a locked door. This function is supported only by certain devices.

- **Enable / Disable Intraday Passage Mode Time Zone**

In remote opening, user can define the door opening duration (The default is 15s). You can select **Enable Intraday Passage Mode Time Zone** to enable the intraday door passage mode time zones, or set the door to Normal Open, then the door will not be limited to any time zones (open for 24 hours).

To close a door, select **Disable Intraday Passage Mode Time Zone** first, to avoid enabling other normal open time zones to open the door, and then select **Remote Closing**.

12.3.4 Reader

Each Entry device has a reader, user can view the reader information in this interface.

Operating Steps

Click **Entrance Control > Channel Device > Reader** to view the reader information such as reader name, barrier gate name, bound camera and it in/out details.

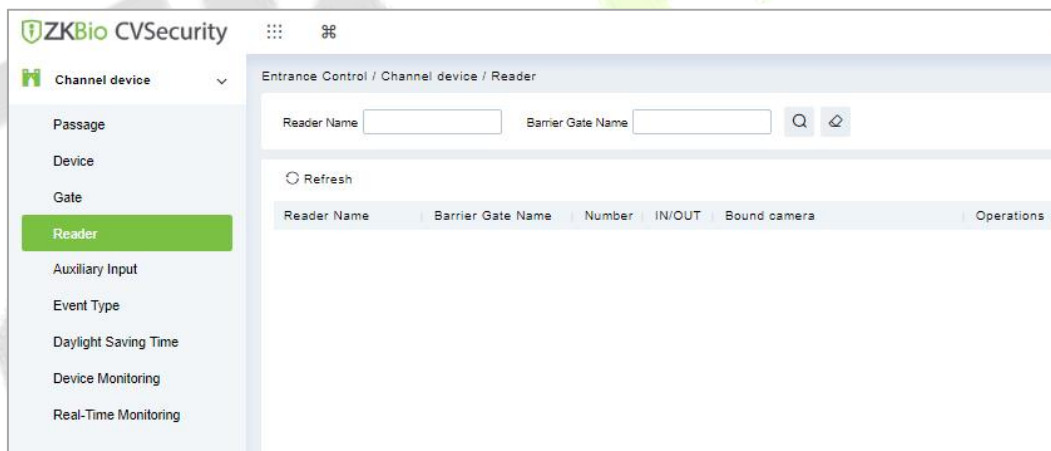

Figure 12-16 Reader Interface

12.3.5 Auxiliary Input

It is mainly used to connect to the devices, such as the infrared sensors or smog sensors.

Click **Entrance Control > Channel Device > Auxiliary Input**, to access below shown interface.

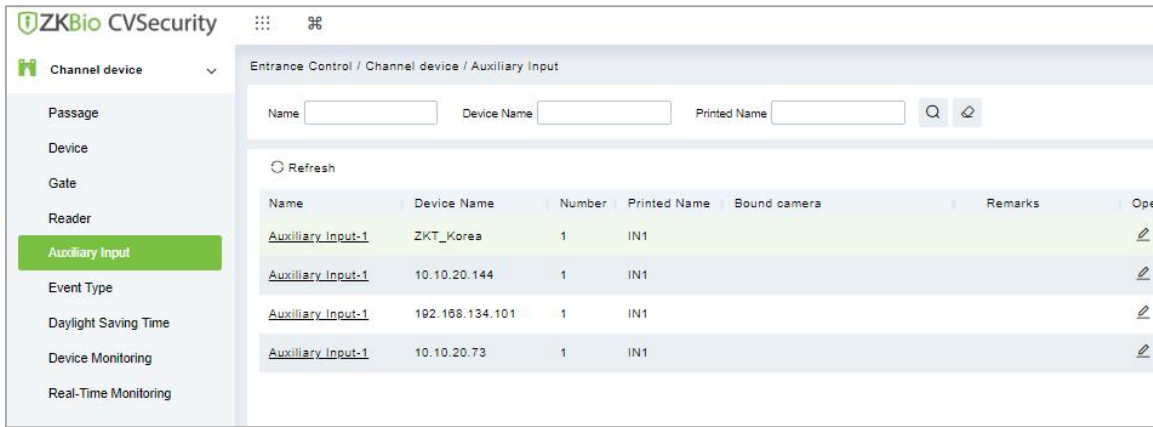

Figure 12-17 Auxiliary input

- **Bind/Unbind Camera**

Through this option, the reader can be connected to the cameras, and the system will make a video linkage (pop-up videos, videos, or screenshots) once there is a corresponding event occurs. For this, the interaction setting in Linkage or in Global Linkage should be done before.

Note: An auxiliary input point can bind more than one channel.

12.3.6 Event Type

The Event Type is mainly used to display various event types included in the channel device. Click **Entrance Control > Channel Device > Event Type**, and the following interface appears

<input type="checkbox"/>	Event Name	Event Number	Event Level	Device Name	Serial Number	Operations
<input type="checkbox"/>	Normal verification opening	0	Normal	192.168.1.105	CM2J205360032	Edit
<input type="checkbox"/>	Verify during normal open time peric	1	Normal	192.168.1.105	CM2J205360032	Edit
<input type="checkbox"/>	Emergency password opening	4	Normal	192.168.1.105	CM2J205360032	Edit
<input type="checkbox"/>	Opening during normal open time p	5	Normal	192.168.1.105	CM2J205360032	Edit
<input type="checkbox"/>	Linkage event triggered	6	Normal	192.168.1.105	CM2J205360032	Edit
<input type="checkbox"/>	Cancel alarm	7	Normal	192.168.1.105	CM2J205360032	Edit
<input type="checkbox"/>	Disable intraday normal open time p	10	Normal	192.168.1.105	CM2J205360032	Edit
<input type="checkbox"/>	Enable intraday normal open time p	11	Normal	192.168.1.105	CM2J205360032	Edit
<input type="checkbox"/>	Remote open auxiliary output	12	Normal	192.168.1.105	CM2J205360032	Edit
<input type="checkbox"/>	Remote close auxiliary output	13	Normal	192.168.1.105	CM2J205360032	Edit
<input type="checkbox"/>	Illegal time period	22	Exception	192.168.1.105	CM2J205360032	Edit
<input type="checkbox"/>	Illegal access	23	Exception	192.168.1.105	CM2J205360032	Edit

Figure 12-18 Event Type

● **Set the sound**

Here, the user can set the event sound. First, select the event to be set sound and then click **Set up Sound** on the page.

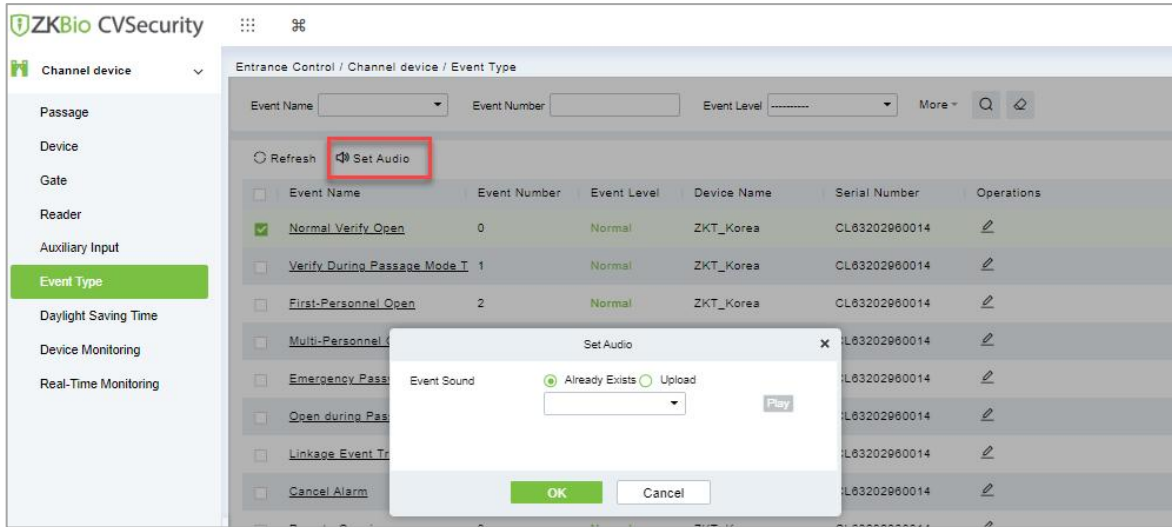

Figure 12-19 Set Sound Option

The audio file can be uploaded locally. The file must be in wav or mp3 format, and the size cannot exceed 10MB.

12.3.7 Daylight Saving Time

DST, also called the Daylight-Saving Time, is a system to adjusting the official prescribe local time to save energy. The unified time adopted during the implementation of known as the "DST". Usually, the clocks are adjusted forward one hour in the summer to make people sleep early and get up early. It can also help to save energy. In autumn, clocks are adjusted backwards. The regulations are different in different countries. At present, nearly 70 countries adopt DST.

To meet the DST requirement, a special function can be customized. You may adjust the clock one hour forward at XX (hour) XX (day) XX (month) and one hour backward at XX (hour) XX (day) XX (month) if necessary.

12.3.7.1 Add DST (New)

Operation Steps:

Step 1: Click **Entrance Control > Channel Device > Daylight saving Time > New**.

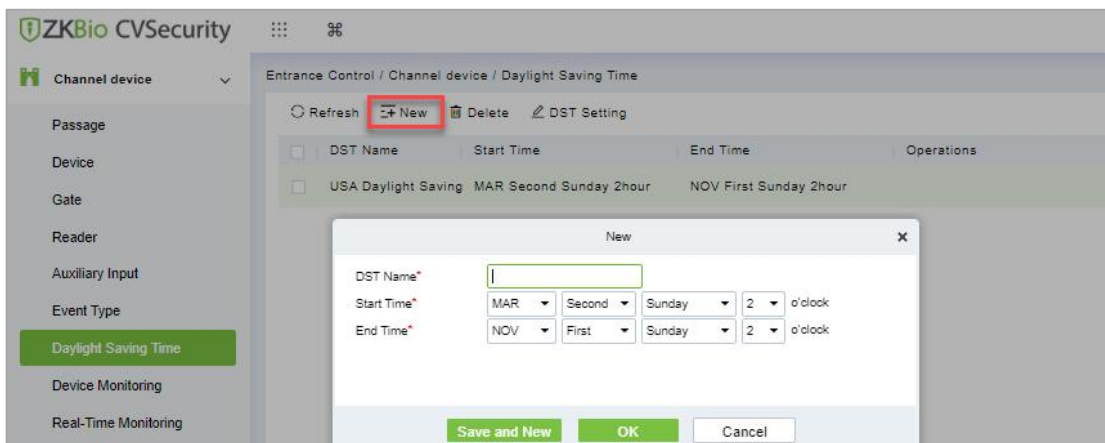

Figure 12-20 Daylight Saving Mode

Set as "Month-Weeks-week hour: minute" format. The start time and end time is needed. For example, the start time can be set as "second Monday in March, 02:00". The system will be advanced one hour at the start time. The system will go back to the original time at the end time.

Parameter	Description
DST Name	Any character, a combination of up to 20 characters, cannot be repeated.
Start and End Time	Enter the start and end time. Set as Month-Weeks-week hour: minute format.

Table 12-2 Description of New DST Parameters

12.3.7.2 Delete

Operation Steps:

Step 1: Click **Entrance Control > Channel Device > Daylight saving Time** and select DST information to be delete.

Step 2: Click **Delete** and click **OK** to delete the DST.

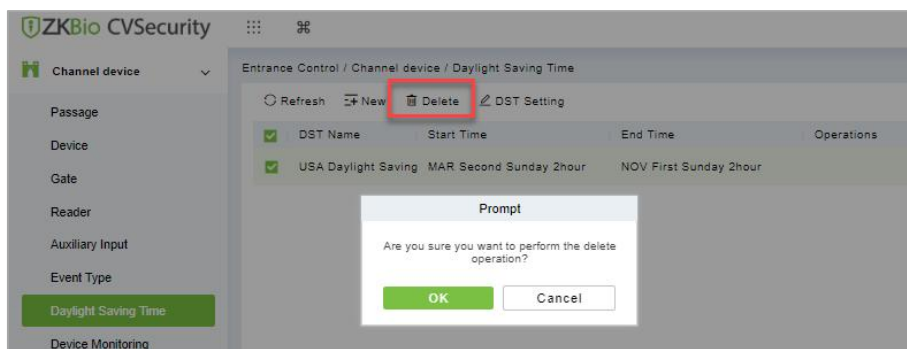

Figure 12-21 Daylight Saving Mode Delete

12.3.7.3 DST Setting

Operation Steps:

Step 1: Click **Entrance Control > Channel Device > Daylight Saving Time** and select DST information to be modify.

Step 2: Click **DST Setting** and select device from the appeared window.

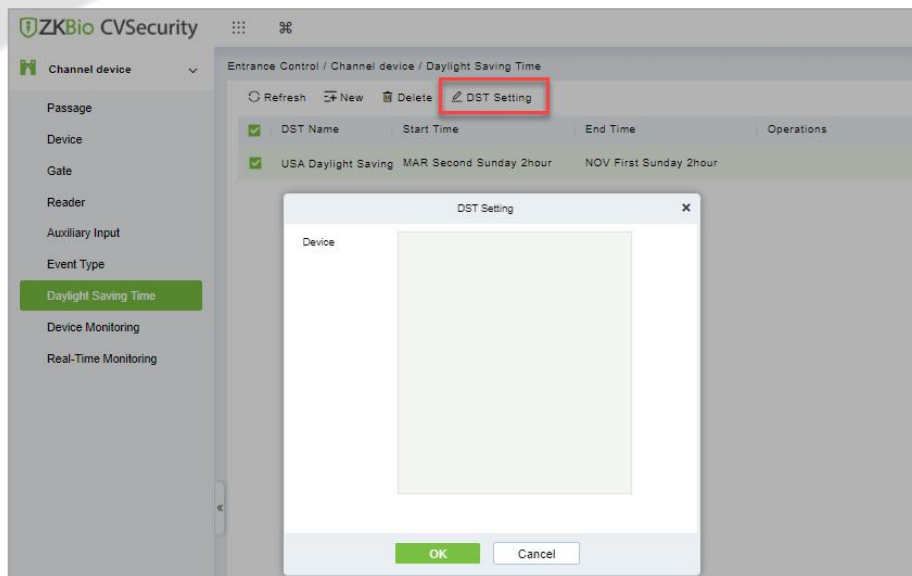

Figure 12-22 DST Setting

Step 3: Click **OK** to save the settings.

12.3.8 Device monitoring

By default, it monitors all devices within the current user's level. You may click **Entrance Control > Channel Device > Device Monitoring** to view a list of operation information of devices: Device Name, Serial No., Area, Operation Status, Current status, Commands List, and Related Operation.

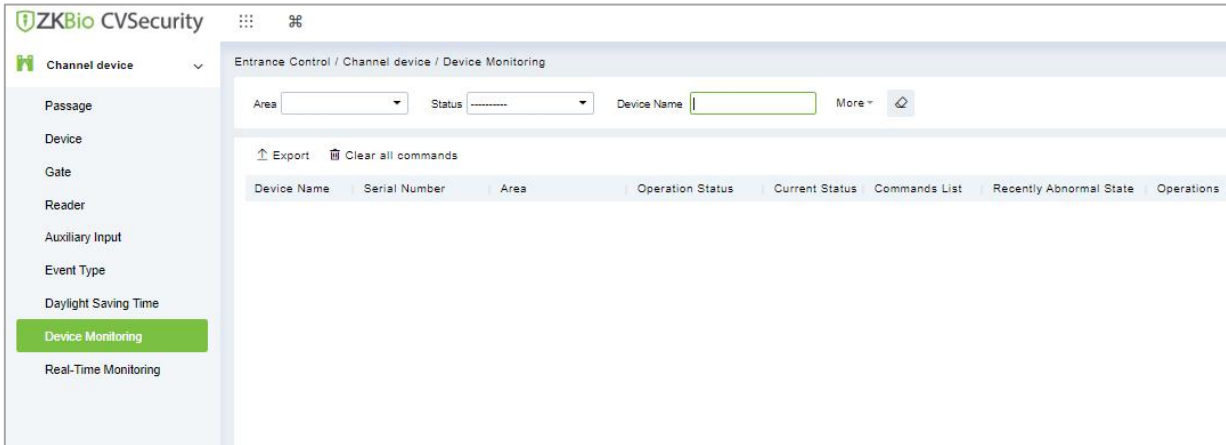

Figure 12-23 Device monitoring interface

12.3.8.1 Export

Device commands can be exported in EXCEL, PDF, CSV file format.

Click **Entrance Control > Channel Device > Device Monitoring > Export** to export the device commands.

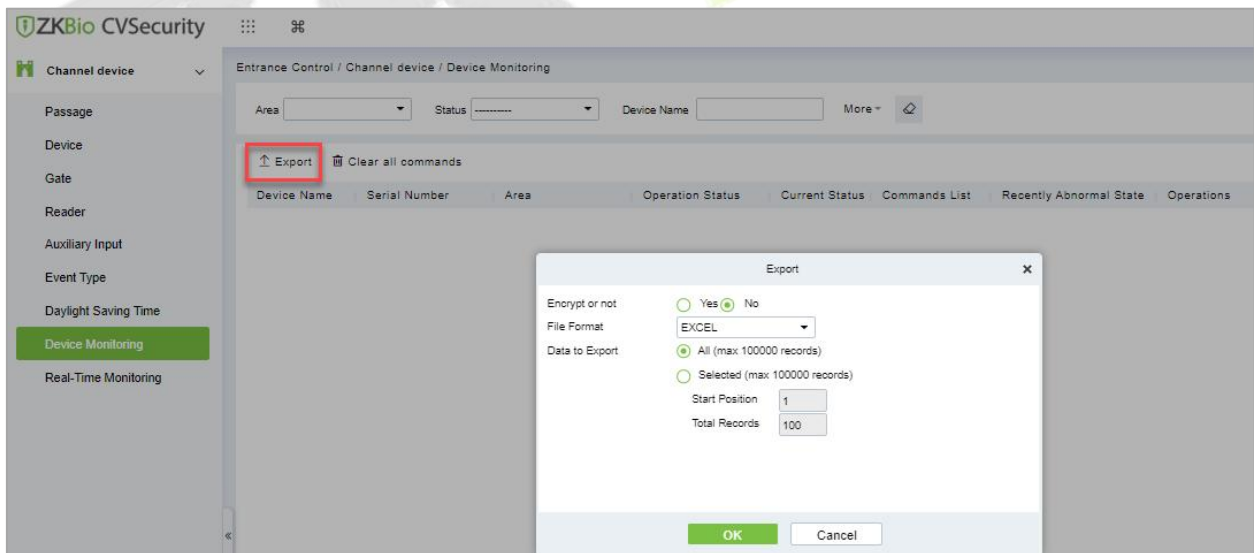

Figure 12-24 Device monitoring Export Option

12.3.8.2 Clear Command

This option allows the users to clear the unwanted command. Click **Entrance Control > Channel Device > Device Monitoring** and select the commands to be delete. Click **Clear Command** in operations column.

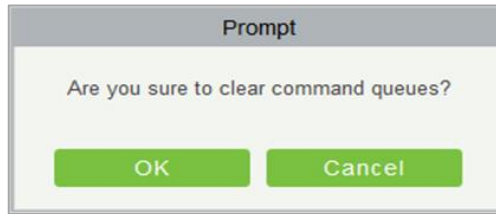

Figure 12-25 Device monitoring Clear command

Click **OK** to clear selected commands.

12.3.9 Real-Time monitoring

On the real-time management screen, the status of the added device is displayed, and the device can be opened or closed. At the same time, the dynamic of real-time events is monitored. If the gate opening can be verified and corresponding access control events can be generated, the access control management service configuration is complete.

12.3.9.1 Remote Gate Opening (in)/(out)

In the **Entrance Control** interface, click **Channel Device > Real Time Monitoring** interface allows the user to control one gate or all gates.

Operation Steps:

Step 1: Check whether the device is online. Check whether the icon status of the added device is online. Click **Barrier Gate** to check and modify the real-time status of the added devices

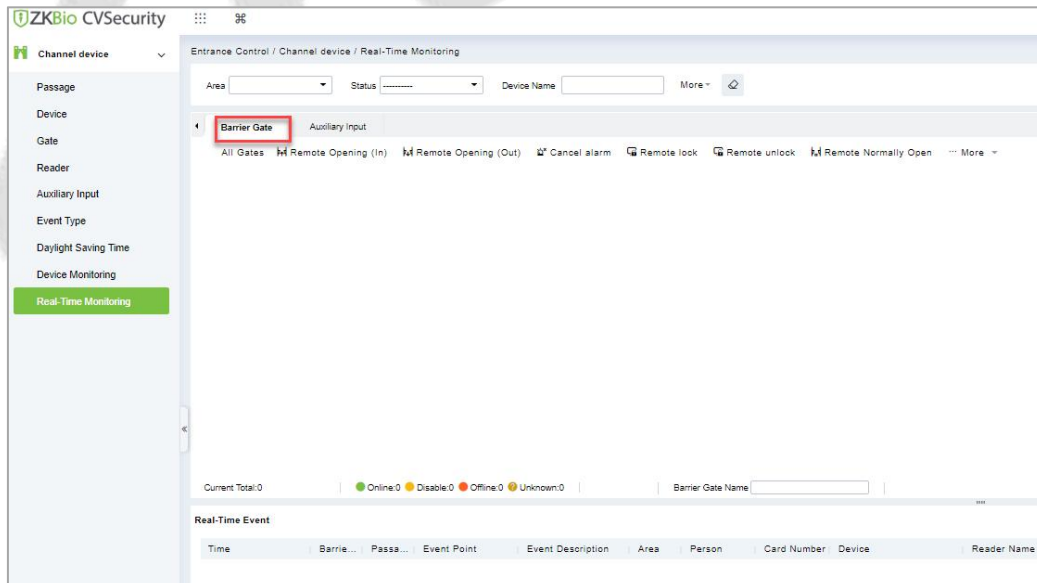

Figure 12-26 Barrier Gate Option in Real-Time Monitoring Interface

Step 2: Remote opening in/out verification, taking remote opening in as an example. Select the online barrier gate device, click **Remote opening in**, enter the user password in the pop-up security verification, and click **OK**.

On the remote door opening screen, enter the time to open the door and tap **OK**. If Operation

succeeded in is displayed, the remote door opening Operation is complete.

12.3.9.2 Cancel the alarm

In the **Entrance Control** interface, click **Channel Device > Real Time Monitoring** interface and select the alarm gate to be modified. Then click **Cancel the Alarm** to cancel the alarm.

Note: If **Cancel the Alarm** fails, check if any devices are disconnected. If found disconnected, check the network.

12.3.9.3 Remote Lock

In the **Entrance Control** interface, click Channel Device > Real-Time Monitoring and select the barrier to modify the lock status Then click Remote Lock to activate the door lockdown status (remote lock and unlock).

It will remotely set the door status to locked status. After this, the door wouldn't receive any operations, such as card reading and remote operations. This function is supported only by certain devices.

12.3.9.4 Remote Unlock

In the **Entrance Control** interface, click **Channel Device > Real-Time Monitoring** and select the barrier to modify the lock status Then click **Remote Unlock** to activate the door lockdown status (remote lock and unlock).

It will unlock a locked door. This function is supported only by certain devices.

Auxiliary Input:

In this interface, the user can identify real-time connected sensor devices such as infrared sensors or smog sensors.

To view the list of real-time connected devices, click **Entrance Control > Channel Device > Real-Time Monitoring** and select **Auxiliary Inputs**.

12.4 Entrance Control

By setting the gate authority group and assigning it to the corresponding personnel, the gate authority of the personnel can be controlled. At the same time, it is also possible to set the response rules to the gate through Anti-Passback and linkage, to meet the requirements of different entry and exit scenarios.

12.4.1 Barrier Gate Permission Group

Gates added to the system should be set in the form of permission groups. Set the corresponding permission group, add gates to the permission group, and define the area where the permission group belongs.

12.4.1.1 To Add Gate Permission (New)

Operating Steps:

Step 1: In the **Entrance Control** module, select **Entrance Control > Barrier Gate Permission Group**. In the barrier gate permission group interface, click **New** in the left column of the mouse to pop up the gate permission group adding interface.

Step 2: In the **New** interface of gate permission group, set the corresponding content according to the new requirements, as shown in Figure 12-27. Please refer to Table 12-3 for parameter filling instructions.

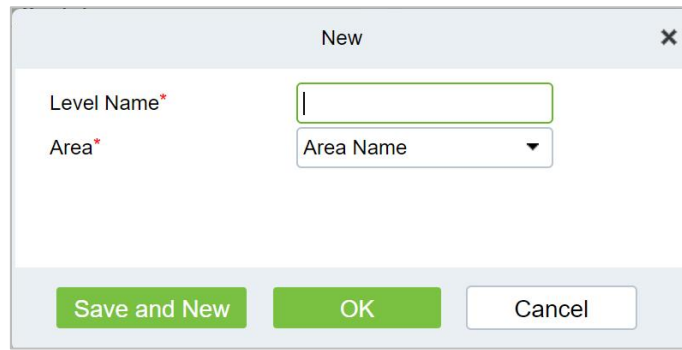



Figure 12-27 Add Gate Permission Group Interface

Parameter	How to set
Level Name	Any character, consisting of up to 30 characters, cannot be repeated.
Aera	Permission groups belong to a zone to which users assigned permissions can manage permission groups under the zone.

Table 12-3 Description of Added Gate Permission Parameters

Step 3: Click **OK** to complete the configuration of the access control authority group.

Step 4: In the gate permission group interface, click **Add Barrier Gate** icon  on the right side of the created gate permission group, and the interface of selecting Add Gate will pop up, and the corresponding gate will be added according to the requirements, as shown in Figure 12-26

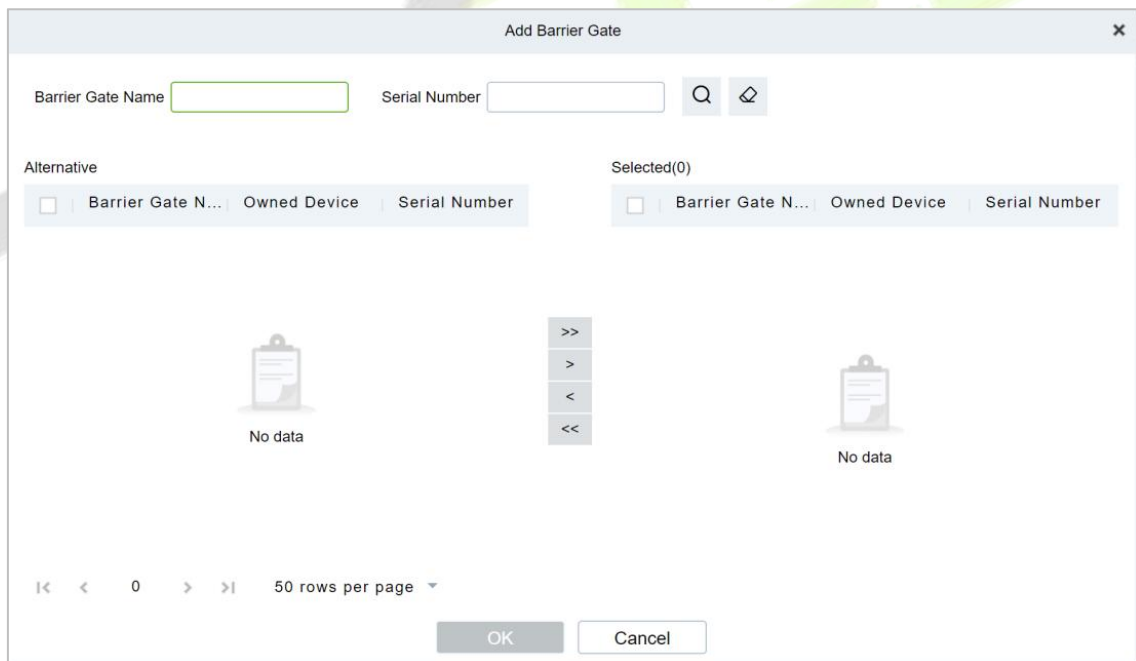

Figure 12-28 Adding Gate Interface

Step 5: Click **OK** to complete the setting of gate permissions.

12.4.1.2 Delete

Operation Steps:

Step 1: Click **Entrance Control** > **Entrance Control** > **Barrier Gate Permission Group** and select gate permission group to be delete.

Step 2: Click **Delete** and click **OK** to delete gate permission group.

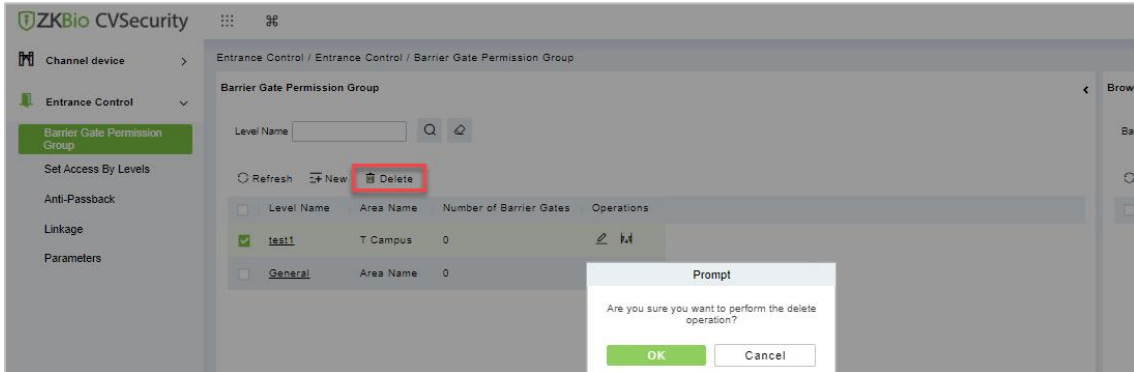

Figure 12-29 Deleting Gate Interface

12.4.1.3 Delete Barrier Gate

Operation Steps:

Step 1: Click **Entrance Control** > **Entrance Control** > **Barrier Gate Permission Group** and select barrier gate name to be delete.

Step 2: Click **Delete** and click **OK** to delete barrier gate from the group.

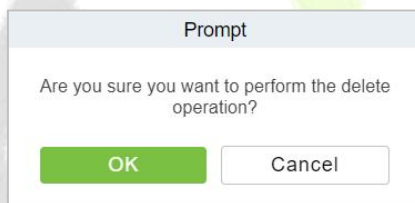

Figure 12-30 Delete Barrier Gate

12.4.1.4 Export

You can export barrier gate details into an Excel, PDF, or CSV file. See the following figure 12-31.

Operating Steps:

Step 1: In **Entrance Control** > **Entrance Control** > **Barrier Gate Permission Group** > **Export** to export the barrier gate records to Excel sheet or PDF or CSV. Enter the User password in the prompt.

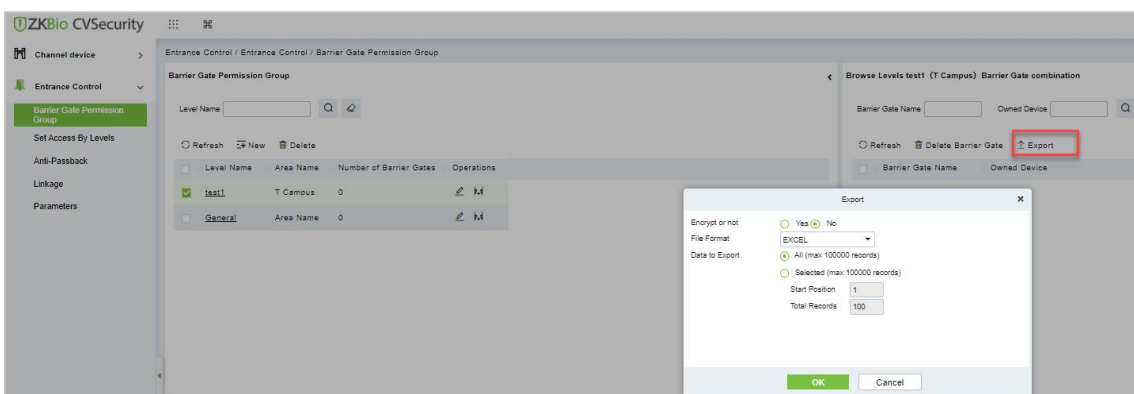

Figure 12-31 Export Interface

Step 2: Select the file format and click **OK**.

12.4.2 Set Access by Levels

Assign the added gate permission group to the person.

Introduces the operation Steps of allocating personnel authority according to authority group in ZKBioCVSecurity.

12.4.2.1 Add Person

Operating Steps:

Step 1: In the **Entrance Control** module, click **Entrance Control > Set Access By Levels**.

Step 2: Click **Add Person** icon  in the operation bar of the corresponding permission group to open the interface of adding person. Select the corresponding person as needed, as shown in Figure 12-31.

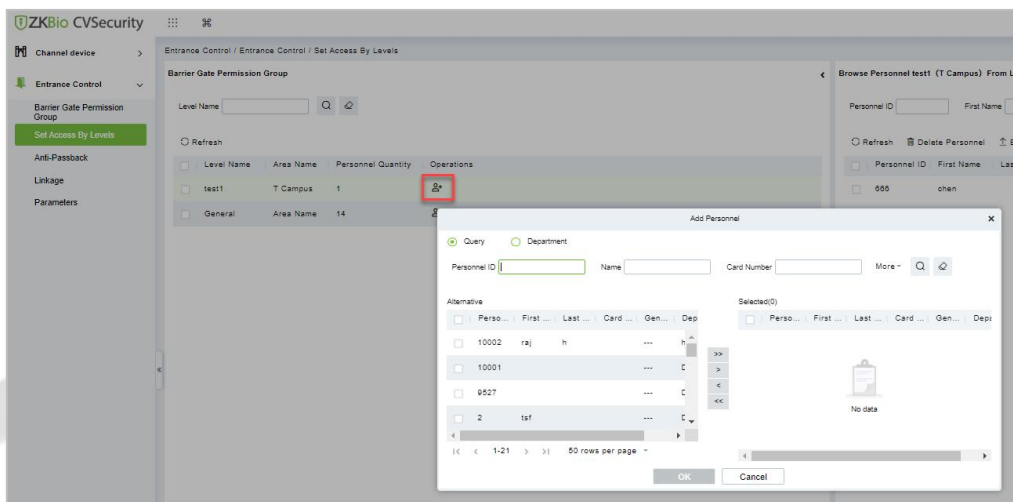

Figure 12-32 Add Person Option

Step 3: Click **OK** to complete the assignment of personnel permissions.

12.4.2.2 Delete Personnel

Operation Steps:

Step 1: Click **Entrance Control > Entrance Control > Set Access By Levels** and select person to be delete.

Step 2: Click **Delete Personnel** and click **OK** to delete barrier gate from the group.

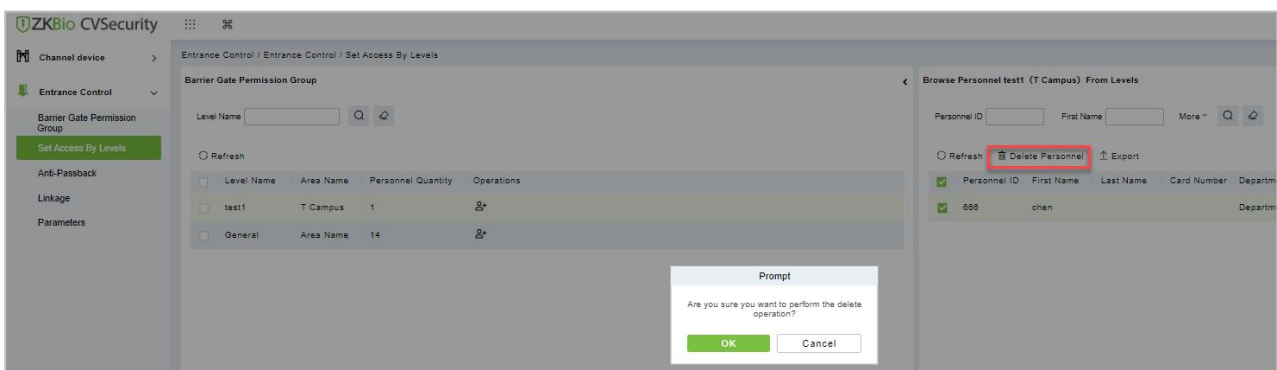

Figure 12-33 Delete Person

12.4.2.3 Export

You can export barrier gate details into an Excel, PDF, or CSV file. See the following figure 10-32.

Operating Steps:

Step 1: In **Entrance Control > Entrance Control > Set Access by Levels > Export** to export the persons records to Excel sheet or PDF or CSV. Enter the User password in the prompt.

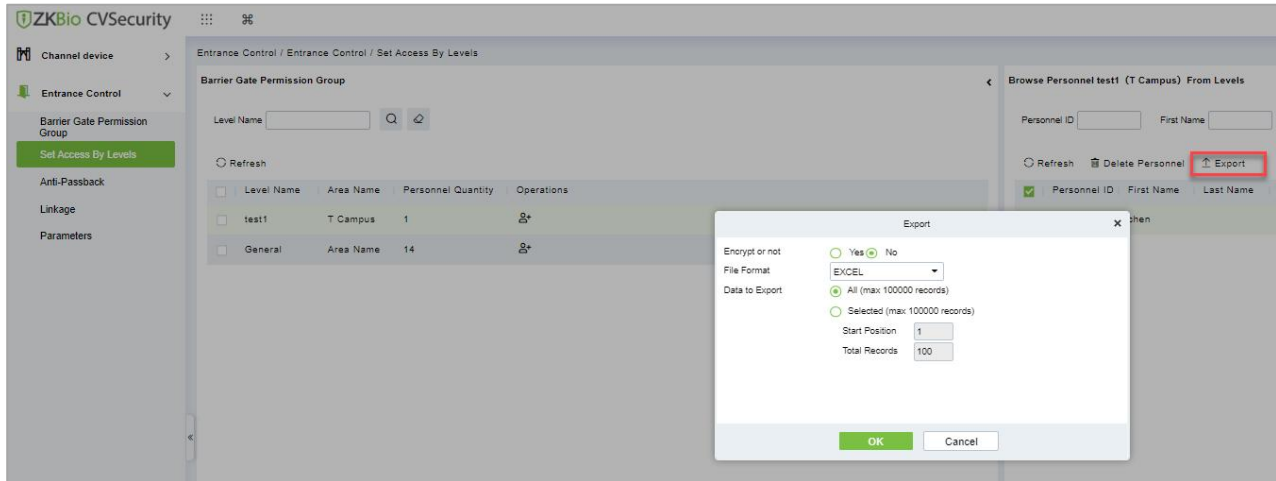

Figure 12-34 Export Interface

Step 2: Select the file format and click **OK**.

12.4.3 Anti-Passback

At present, it supports Anti-Passback in and out. On some occasions, people who require card swiping verification must swipe their cards from another channel when they come in from one channel, and the card swiping records must be strictly corresponding to one entry and one exit. Users can use this function when they enable it in settings, which is generally used in special units, scientific research, bank vaults and other occasions.

12.4.3.1 To Add Anti-Passback

This paper introduces the configuration Steps of adding Anti-Passback effect in.

Operating Steps:

Step 1: In the **Entrance Control** module, select **Entrance Control > Anti-Passback** and Click **New**.

Step 2: Select the specified device.

Description:

When adding Anti-Passback, you can't see the device that has been set up in Anti-Passback in the device list. After deleting the set Anti-Passback information, the device returns to the device list.

Anti-Passback settings of all-in-one machine: Anti-Passback, Anti-Passback and Anti-Passback.

Step 3: Select the Anti-Passback rule and click **OK** to complete the setting, as shown in Figure 12-35. The newly added Anti-Passback settings are displayed in the list of selected Anti-Passback rules.

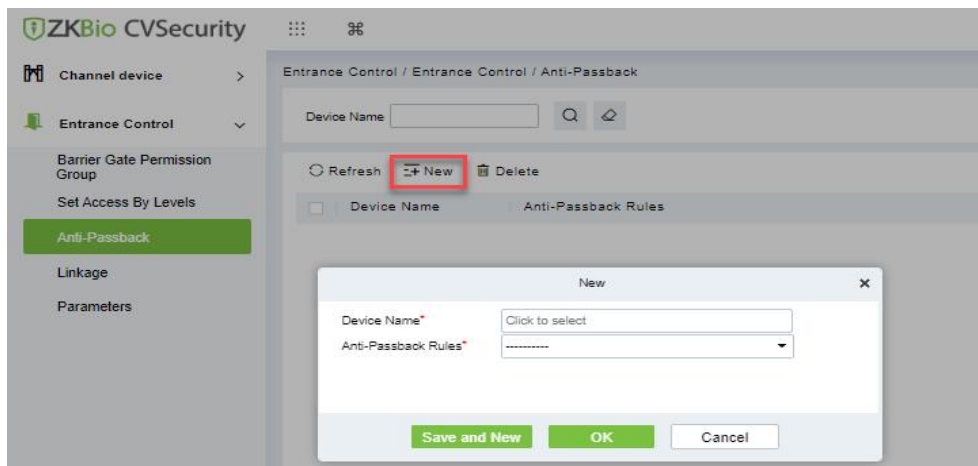

Figure 12-35 Add Anti-Passback Interface

12.4.3.2 Delete

Operation Steps:

Step 1: Click **Entrance Control > Entrance Control > Anti-Passback** and select device name to be delete.

Step 2: Click **Delete** and click **OK** to delete Anti-passback from the group.

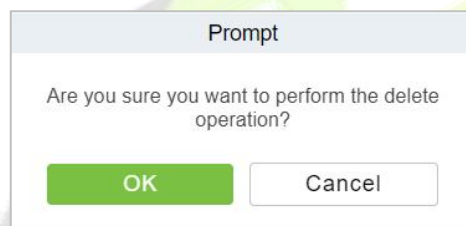

Figure 12-36 Delete Anti-Passback

12.4.4 Linkage Setting

After a specific event is triggered at a certain input point in the channel system, a linkage action will be generated at the specified output point to control the events such as verification opening, alarm and anomaly in the system, which will be displayed in the corresponding event list monitored.

Precondition:

Before linking new configurations, you need to do the following:

1. Gate device, input point, output point, read head binding camera add settings.
2. Mailbox parameter configuration.

12.4.4.1 Add Linkage

Operating Steps:

Step 1: In the **Entrance Control** module, select **Entrance Control > Linkage**.

Step 2: In the linkage setting interface, select and click the **New** button to fill in the corresponding parameters, as shown in Figure 12-37. Please refer to Table 12-4 for linkage parameters.

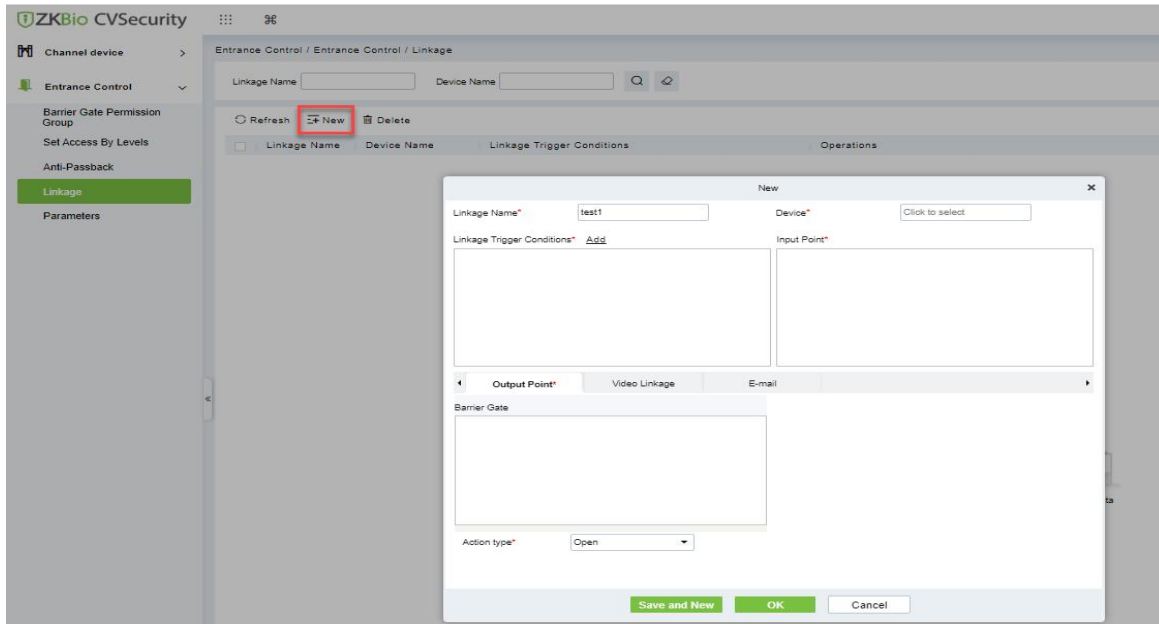

Figure 12-37 New Linkage Interface

Parameter	Description
Linkage Name	Custom setting linkage name for easy reference.
Device	Customize and select the added access control device.
Linkage Trigger Conditions	Select the condition under which the linkage operation is triggered, that is, the type of event generated by the selected device.
Input Point	Select the input point to set the device input.
Output Point	Select the output point to set the output of the device.
Action Type	Choose to set up linkage action, including device operation of output point, video linkage and mail. Refer to Table 12-5 for configuration description of the three modes.

Table 12-4 Description of New Linkage Parameters

Parameter	Description
Output Point	Set the action type of output point: closed, open and normally open. Sets the delay time if the output point action is on.
Video Linkage	Pop-up video, display duration: check the pop-up video in the real-time monitoring interface and set the pop-up duration. Video recording and video recording duration: Check to record and set the video recording duration. Capture: Set whether the linkage action takes pictures: If you take pictures, you also need to set whether it pops up in the real-time monitoring interface and the display time.
E-mail	Set the email address of the received linkage content when the linkage event occurs.

Table 12-5 Explanation of Output Action Parameters

Step 3: Click **OK** to complete the linkage configuration.

12.4.4.2 Delete

Operation Steps:

Step 1: Click **Entrance Control > Entrance Control > Linkage** and select the linkage name to be delete.

Step 2: Click **Delete** and click **OK** to delete linkage.

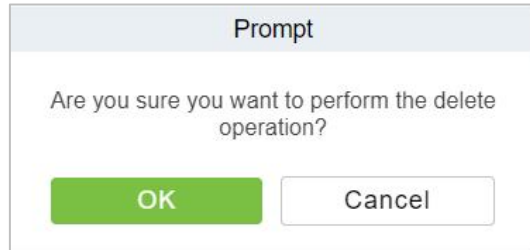

Figure 12-38 Delete Linkage

12.4.5 Parameters

Click **Entrance Control > Entrance Control > Parameter** to enter the parameter setting interface.

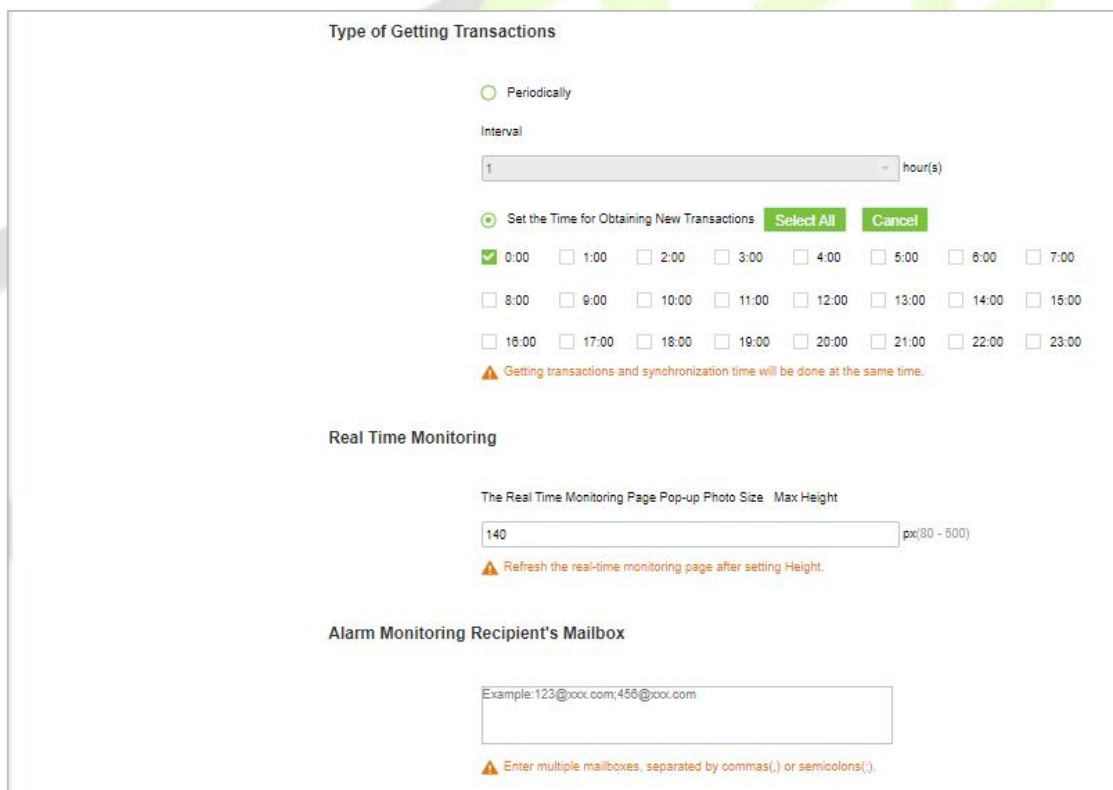

Figure 12-39 Add Parameters

Type of Getting Transactions:

- **Periodically**

Start from the setting and efficient time, the system attempts to download new transactions every time interval.

● **Set the Time for Obtaining New Transactions**

The selected Time is up, the system will attempt to download new transactions automatically.

The Real Time Monitoring Page Pop-up Staff Photo Size: When an access control event occurs, the personnel photo will pop up. The size of pop photos shall be between 80 to 500 pixels.

Alarm Monitoring Recipient Mailbox: The system will send email to alarm monitoring recipient’s mailbox if there is any event.

12.5 Passage Settings

By maintaining the gate traffic rules (control time period and traffic mode) and setting the gate parameters corresponding to the gate, the gate function can be directly controlled by software.

12.5.1 Barrier gate passing Rules

Set the passage time and passage mode of the gate, so that the gate can set different entry and exit passage modes in different time periods. It can be applied to flap Barrier and swing Barrier.

12.5.1.1 Add Barrier Gate Passing Rules

This paper introduces the configuration Steps of gate traffic rules in ZKBioCVSecurity.

Operating Steps:

Step 1: In the **Entrance Control** module, select **Passage Settings > Barrier Gate Passing Rules**.

Step 2: Click **New** with the mouse, and the interface for adding gate traffic rules will pop up.

Step 3: In the new interface, set the corresponding contents according to the new requirements, as shown in Figure 12-40. Please refer to Table 12-6 for parameter setting instructions.

The screenshot shows a 'New' dialog box with the following elements:

- Name of the Barrier Gate Passing Rule ***: A text input field.
- Remarks**: A text input field.
- Table**: A table with columns for Date, Time, Interval 1 (Start Time, End Time, Pass Mode), Interval 2 (Start Time, End Time, Pass Mode), and Interval 3 (Start Time, End Time, Pass Mode). The rows represent days from Monday to Sunday.
- Copy Monday's Setting to Others Weekdays:** A checkbox.
- Buttons**: 'Save and New', 'OK', and 'Cancel'.

Figure 12-40 Interface of Adding Gate Traffic Rules

Parameter	Description
Name of Gate Traffic Rules	Any character, up to 30 characters.
Remarks	The explanation of the current time period and the main application occasions shall consist of 50 characters at most.

Time Interval	A gate passage rule contains up to five-time intervals in a week.
Time Interval-Start/End Time	Set the start and end time in each time interval.
Pass Mode	Set the traffic mode in each time interval and select it from drop-down. There are 10 traffic modes by default: "Two-way controlled", "free entry and exit controlled", "controlled entry and exit free", "two-way freedom", "forbidden entry and exit controlled", "forbidden entry and exit free entry", "free entry and exit forbidden entry", "two-way prohibition", "remote normal opening".
Copy Monday Time to Other Working Days	You can quickly copy Monday settings to other workdays.

Table 12-6 Parameter Description of Gate Traffic Rules

Step 4: Click **OK** to complete the addition of the gate traffic rules.

12.5.1.2 Delete Passage

Operation Steps:

Step 1: In the **Entrance Control** module, select **Passage Settings > Barrier Gate Passing Rules**. and select the rule to be deleted.

Step 2: Click **Delete** to delete the selected rule.

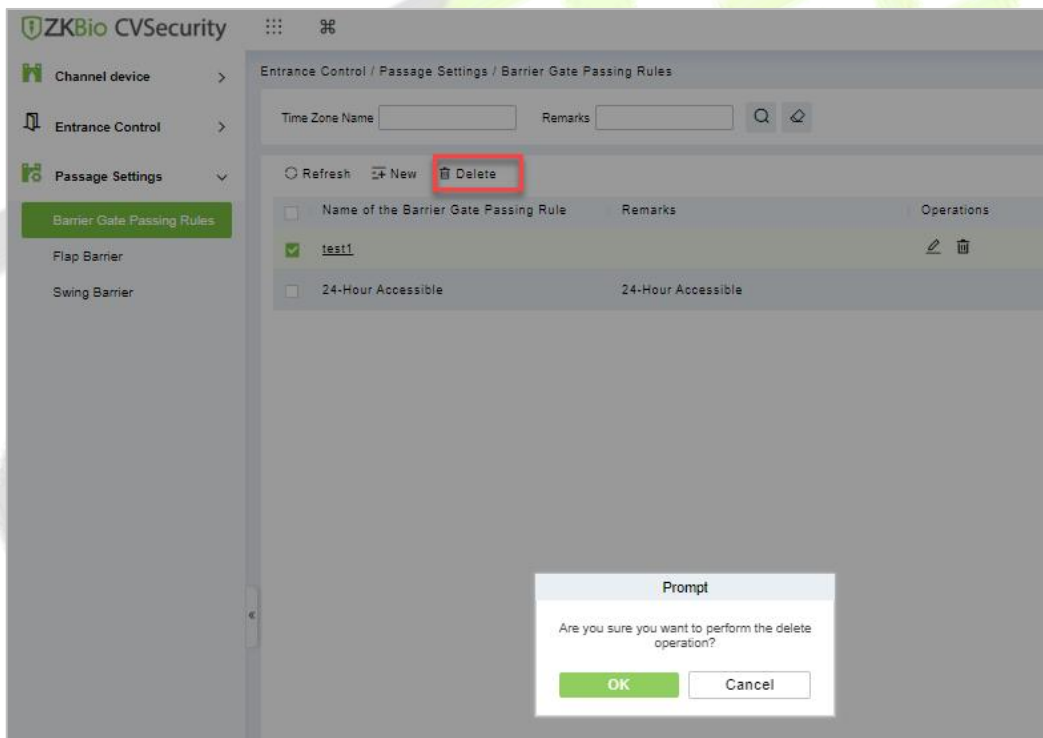

Figure 12-41 To Delete Barrier Gate Passage Rule

Step 3: Click **OK** to perform the delete operation.

12.5.2 Flap Barrier

Introduces the parameter configuration Steps of wing Barrier in ZKBioCVSecurity.

Operating Steps:

Step 1: In the **Entrance Control** module, select **Passage Settings > Flap Barrier**.

Step 2: In the flap Barrier interface, click the **Edit** button under the name or operation of the flap Barrier to enter the flap Barrier parameter editing interface, as shown in Figure 12-42. Please refer to Table 12-7 for parameter description.

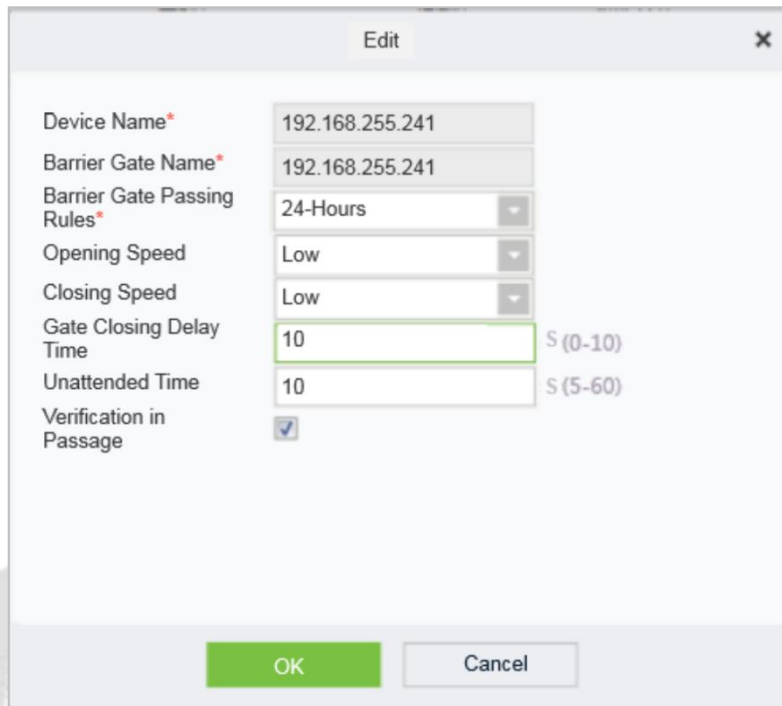

Figure 12-42 Flap Barrier Parameter Configuration Interface

Parameter	How to set
Device Name	Name of flap Barrier device, non-editable.
Barrier Gate Name	Custom Setting Notes Description.
Barrier Gate Traffic Rules	Drop-down selection, the option is taken from the data of Passage Setting > Barrier Gate Passing Rules.
Opening Speed/ Closing Speed	Low speed, medium speed and high speed, set the speed of opening and closing the gate.
Gate Closing Delay Time	After passing through the last pair of infrared channels, set the delay closing time. You can set 0 to 10s, and the default is 0s.
Unattended Time	The maximum waiting time after verification is 5 to 60s, and the default value is 10s. If no pedestrians pass beyond the set time, the gate will be closed.
Verification in Passage	No authentication in the channel is allowed. <ul style="list-style-type: none"> • When checked the verification in the channel can open the gate; • If it is not checked, the gate cannot be opened for verification in the channel, and the gate can be verified only after exiting the gate.

Table 12-7 Explanation of Flap Barrier Parameters

Step 3: Click **OK** to complete the configuration of flap Barrier parameters.

12.5.3 Swing Barrier

This paper introduces the parameter configuration Steps of swing Barrier in ZKBioCVSecurity.

Operating Steps:

Step 1: In the **Entrance Control** module, select **Passage Settings > Swing Barrier**.

Step 2: In the swinging interface, click the **Edit** button under the swinging name or operation to enter the swinging parameter editing interface, as shown in Figure 12-43. Please refer to Table 12-8 for parameter description.

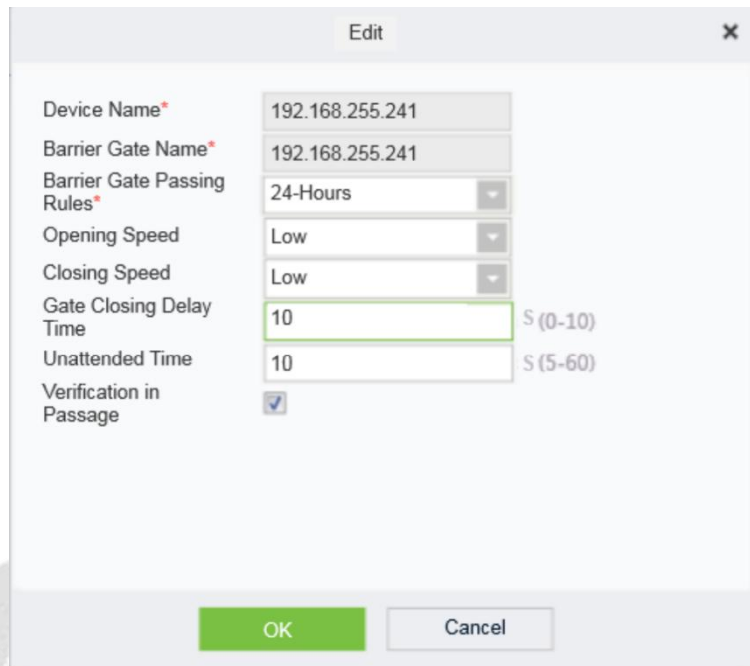

Figure 12-43 Swing Barrier Parameter Configuration Interface

Parameter	How to set
Device Name	The name of the swing Barrier device cannot be edited.
Barrier Gate Name	The gate name corresponding to the swing gate device is generally one all-in-one device corresponding to one gate, which cannot be edited.
Barrier Gate Traffic Rules	Drop-down selection, the option is taken from the data of Passage Setting > Barrier Gate Passing Rules.
Opening Speed/ Closing Speed	Low speed, medium speed and high speed, set the speed of opening and closing the gate.
Gate Closing Delay Time	After passing through the last pair of infrared channels, set the delay closing time. You can set 0 to 10s, and the default is 0s.
Unattended Time	The maximum waiting time after verification is 5 to 60s, and the default value is 10s. If no pedestrians pass beyond the set time, the gate will be closed.
Verification in Passage	Whether authentication in the channel is allowed. <ul style="list-style-type: none"> • When checked the verification in the channel can open the gate; • If it is not checked, the gate cannot be opened for verification in the channel, and the gate can be verified only after exiting the gate.

Table 12-8 Description of Swing Barrier Parameters

Step 3: Click **OK** to complete the configuration of wing Barrier parameters.

12.6 Channel Reports

In the Channel report, you can query the All Transactions, Today's Access Records, Person's Last Access Location, and All Exception Events. You can choose to export all or export records after querying.

12.6.1 All Transactions

This paper introduces the configuration Steps of report query and export in, taking All Transaction report operation.

12.6.1.1 Export

Operating Steps:

Step 1: In the **Entrance Control** module, select **Channel Reports> All Transactions**.

Step 2: In the All Records interface, fill in the corresponding query information and click the **Query** symbol to complete the query of all record tables, as shown in Figure 12-44.

Entrance Control / Channel Reports / All Transactions

Time From 2021-09-20 00:00:00 To 2021-12-20 23:59:59 Personnel ID Device Name Retract

Department Number Department Name Event Description

Card Number Reader Name Verification Mode

Area Name Event Point Name

Figure 12-44 All Transactions

Step 3: In the full record interface, click **Export**, enter the user password in the pop-up security verification, and click **OK**. Select whether to encrypt and export the file format, and Click **OK**, as shown in Figure 12-45.

Export

Encrypt or not Yes No

File Format EXCEL

Data to Export All (max 100000 records) Selected (max 100000 records)

Start Position 1

Total Records 100

OK Cancel

Figure 12-45 Report Export Interface

Step 4: After selecting the address where the corresponding file is stored, the export of the file can be completed.

12.6.1.2 Clear All Data

This option allows user to clear all data available in all transaction interface.

Operating Steps:

Step 1: In the **Entrance Control** module, select **Channel Reports> All Transactions**.

Step 2: Click the **Clear All Data** to clear all transactions.

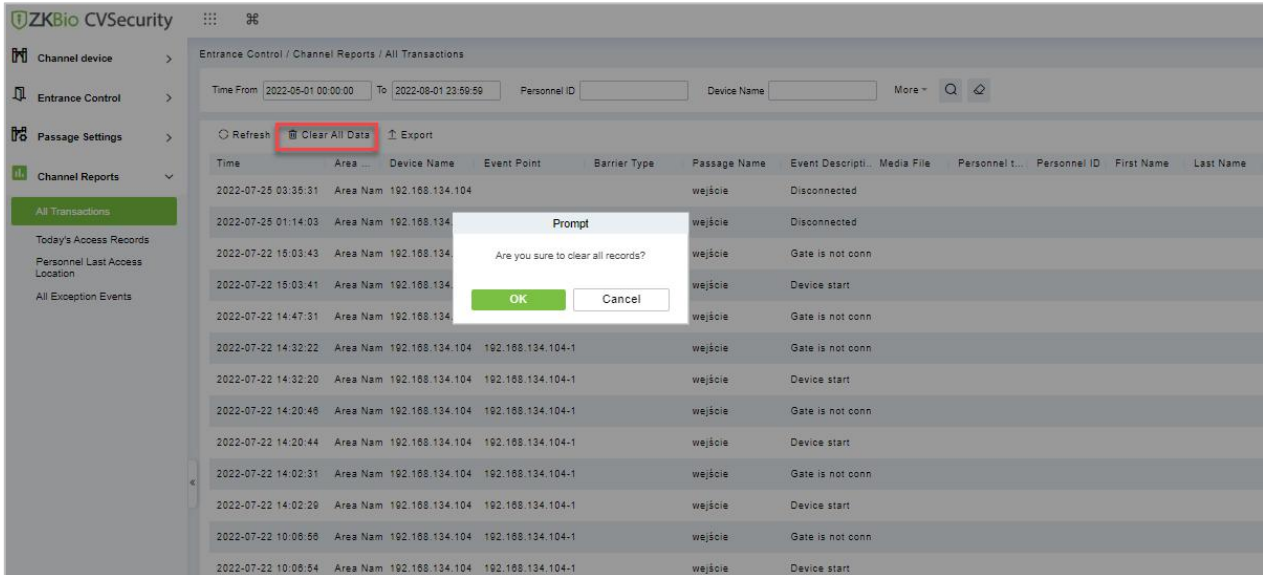

Figure 12-46 Clear All Data Option

Step 3: Click **OK** to clear all records.

12.6.2 Today's Access Record

The access records for today are displayed in this option.

12.6.2.1 Export

Operating Steps:

Step 1: In the **Entrance Control** module, select **Channel Reports > Today's Access Record**.

Step 2: In Today's Access Record interface, fill in the corresponding query information and click the **Query** symbol to complete the query of access record tables, as shown in Figure 12-47.

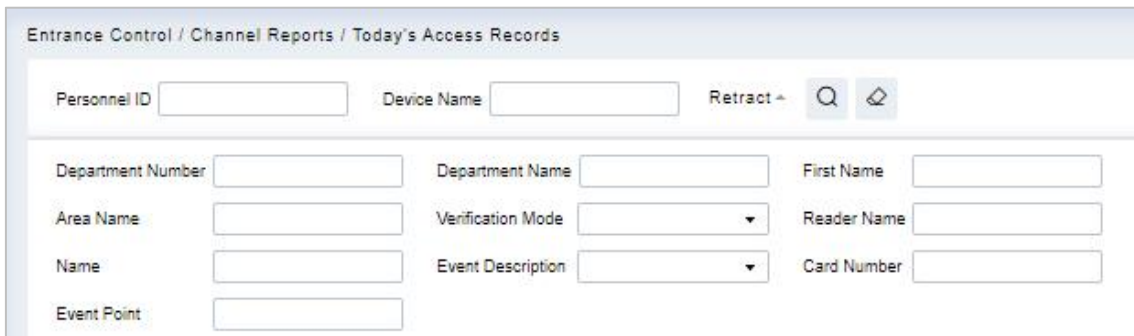

Figure 12-47 Today's Access Record

Step 3: In the access record interface, click **Export**, enter the user password in the pop-up security verification, and click **OK**. Select whether to encrypt and export the file format, and Click **OK**, as shown in Figure 12-48.

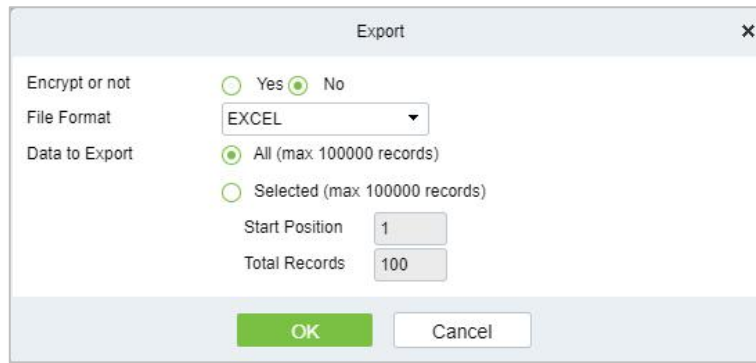

Figure 12-48 Report Export Interface

Step 4: After selecting the address where the corresponding file is stored, the export of the file can be completed.

12.6.2.2 Clear All Data

This option allows users to clear all data available in today’s access record interface.

Operating Steps:

Step 1: In the **Entrance Control** module, select **Channel Reports> Today’s Access Record**.

Step 2: Click the **Clear All Data** to clear access records.

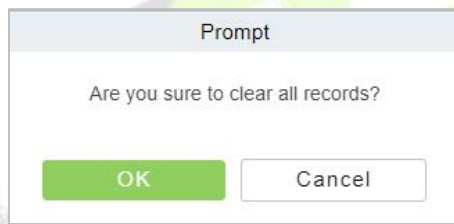

Figure 12-49 Clear All Data Option

Step 3: Click **OK** to do the delete operation.

12.6.3 Personnel Last Access Location

Displays the last location visited by persons with access rights. It is convenient for users to quickly locate the location of personnel.

12.6.3.1 Export

Operating Steps:

Step 1: In the **Entrance Control** module, select **Channel Reports > Personnel Last Access Location**.

Step 2: In Personnel Last Access Location interface, fill in the corresponding query information and click the **Query** symbol to complete the query of access record tables, as shown in Figure 12-50.

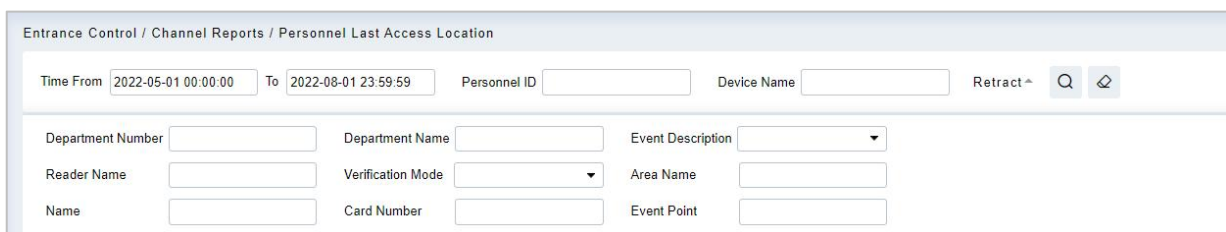

Figure 12-50 Today’s Access Record

Step 3: In the access location interface, click **Export**, enter the user password in the pop-up security

verification, and click **OK**. Select whether to encrypt and export the file format, and Click **OK**, as shown in Figure 12-51.

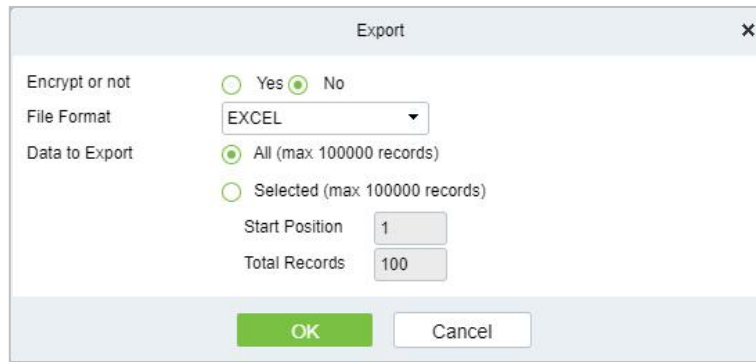

Figure 12-51 Report Export Interface

Step 4: After selecting the address where the corresponding file is stored, the export of the file can be completed.

12.6.3.2 Clear All Data

This option allows users to clear all data available in Personnel Last Access Location interface.

Operating Steps:

Step 1: In the **Entrance Control** module, select **Channel Reports > Personnel Last Access Location**.

Step 2: Click the **Clear All Data** to clear the access location records of the persons, as shown in Figure 12-49.

Step 3: Click **OK** to do the delete operation.

12.6.4 All Exception Events

Click **Channel Report > All Exception Events** to view the abnormal events (including alarm events) such as unregistered persons, illegal entry, gate opening timeout, and failure to connect to the server under specified conditions (including alarm events).

12.6.4.1 Export

Operating Steps:

Step 1: In the **Entrance Control** module, select **Channel Reports > All Exception Events**.

Step 2: In All Exception Events interface, fill in the corresponding query information and click the **Query** symbol to complete the query of access record tables, as shown in Figure 12-52.

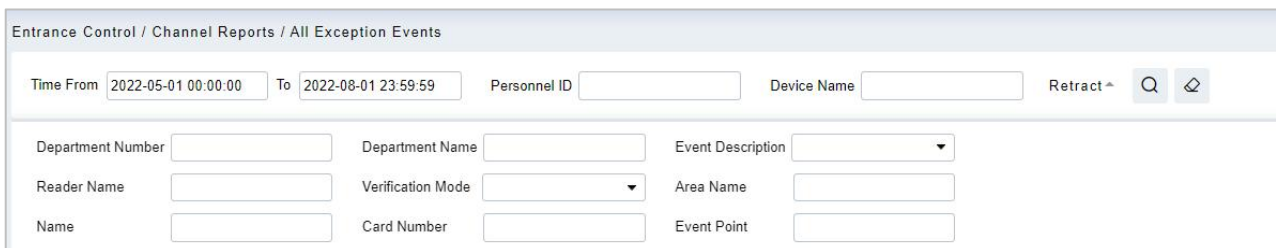

Figure 12-52 All Exception Events

Step 3: In the All-Exception Events interface, click **Export**, enter the user password in the pop-up security verification, and click **OK**. Select whether to encrypt and export the file format, and Click **OK**, as shown in Figure 12-53.

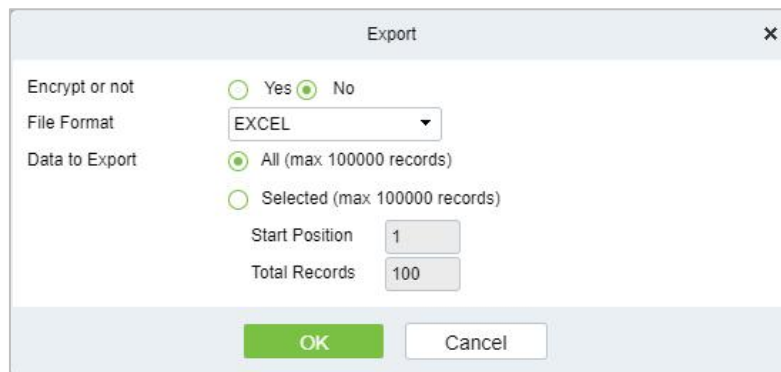

Figure 12-53 Report Export Interface

Step 4: After selecting the address where the corresponding file is stored, the export of the file can be completed.

12.6.4.2 Clear All Data

This option allows users to clear all data available in All Exception Events interface.

Operating Steps:

Step 1: In the **Entrance Control** module, select **Channel Reports > All Exception Events**.

Step 2: Click the **Clear All Data** to clear exception events record.

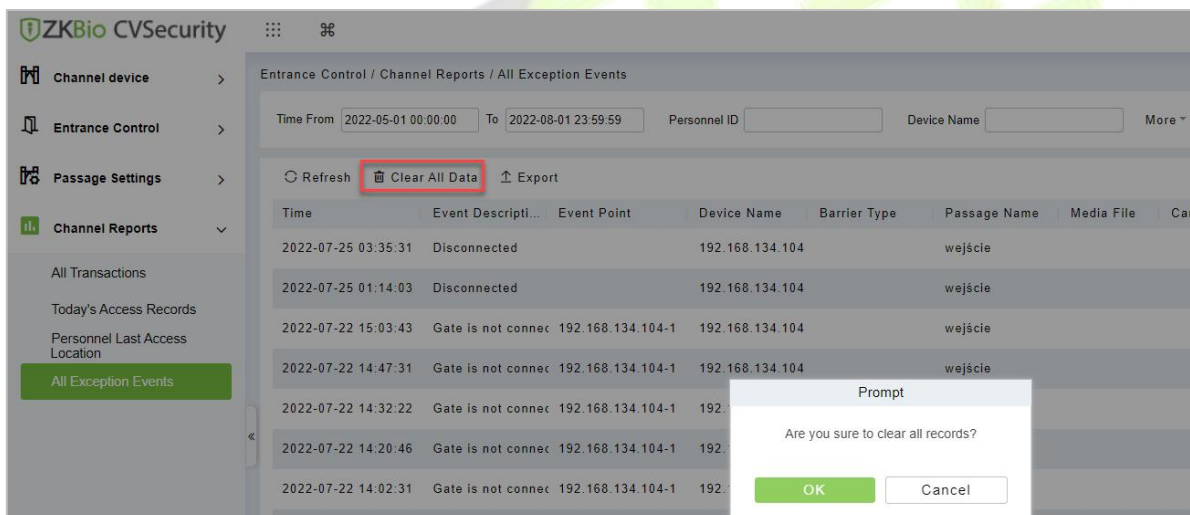

Figure 12-54 Clear All Data Option

Step 3: Click **OK** to do the delete operation.

13 Temperature Detection

MTD (Mask and Temperature Detection) module is primarily designed to work with access control devices which have body temperature detection and mask detection features. It provides real-time monitoring of temperature and mask detection of all the users and various analysis reports.

13.1 Operation Scenario

Under the epidemic situation, the device measures the body temperature of real-time monitoring personnel, alarms and monitors the abnormal body temperature records, and summarizes and warns these records, so that managers can take timely measures and play an active role in epidemic prevention.

13.2 Operation Flow

This paper introduces the configuration process of epidemic prevention management business.

The configuration process of epidemic prevention management business is shown in Figure 13-1.

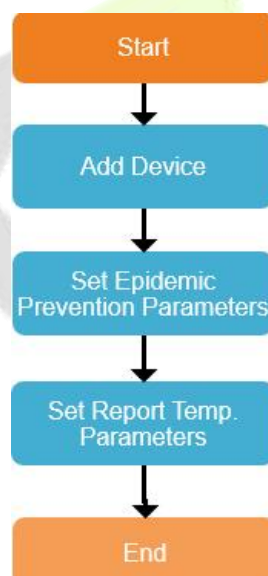

Figure 13-1 Epidemic Prevention Configuration Process

13.3 Setting Of Epidemic Prevention Parameters

This paper introduces the configuration Steps of epidemic prevention parameters in ZKBioCVSecurity.

Precondition:

In "Access Control Management", add a device supporting body temperature detection, please refer to 3.3 for adding a device.

Operating Steps:

Step 1: In the **Access Control** module, select **Device > Device**.

Step 2: After selecting the device, click "**settings > Setting Extension Parameters**" to pop up the interface.

Step 3: In the interface of setting extended parameters, you can view the epidemic prevention parameters on the device, as shown in Figure 13-2. Please refer to Table 13-1 for parameter configuration.

Description:

Epidemic prevention parameters are set and changed on the device side.

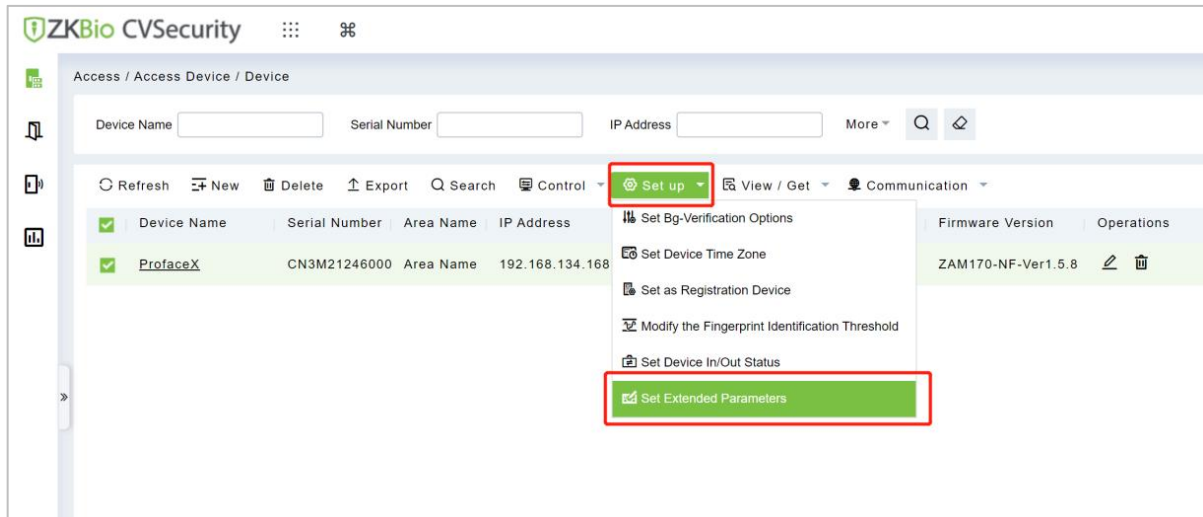

Figure 13-2 Setting Interface of Epidemic Prevention Parameters

Parameter	Description
Body Temperature Detection Attribute	<ul style="list-style-type: none"> Open: turn on the temperature measurement function. Close: Turn off the temperature measurement function.
Abnormal Body Temperature Is Impassable	<ul style="list-style-type: none"> Open: abnormal body temperature passes. Close: Abnormal body temperature does not pass.
Upper Limit of Temperature Detection Threshold	Set the threshold of device body temperature, if it exceeds, the body temperature will be abnormal.
Temperature Correction Deviation Value	Adjust the deviation value of device body temperature.
Temperature Unit	Celsius, Fahrenheit
Infrared Temperature Measuring Distance	Near, medium, and far.
Mask Detection Attribute	<ul style="list-style-type: none"> Open: Test mask. Close: Do not test masks.
Trigger The External Alarm Function	<ul style="list-style-type: none"> Open: Open the external alarm function. Turn off: Turn off the external alarm function.
Allow Unregistered Personnel to Pass	Carry out normal temperature measurement.

Table 13-1 Description of Epidemic Prevention Parameters

Step 4: Click **OK** to complete the configuration of epidemic prevention parameters.

13.3.1.1 Result Validation

In the real-time monitoring interface of epidemic prevention management, the real-time events of temperature measurement and epidemic prevention can be obtained correctly, and the information can be displayed correctly, which represents the completion of epidemic prevention management business configuration.

Precondition:

In the **Epidemic Prevention** module, select "**Epidemic Prevention Management > Parameter**

Setting to set the temperature threshold setting, which is used for the data statistical basis in the epidemic prevention report, as shown in Figure 13-3.

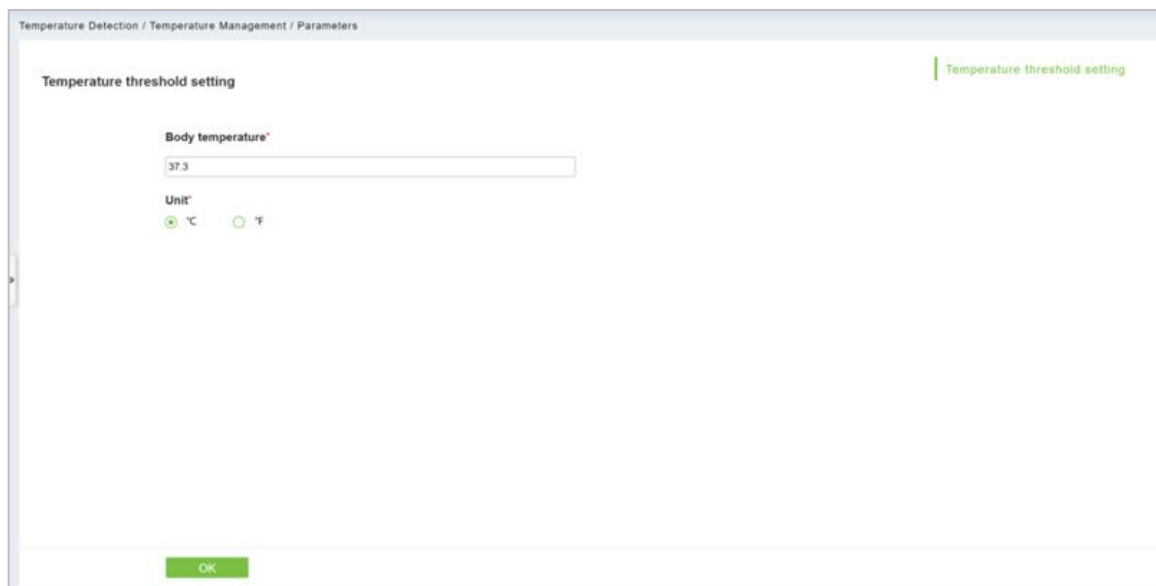

Figure 13-3 Parameter Setting Interface of Epidemic Prevention Report

Operating Steps:

Step 1: In the **Epidemic Prevention** module, select "**Epidemic Prevention Management > Real-time Monitoring**".

Step 2: After opening the real-time monitoring interface, carry out temperature measurement verification on the temperature measuring device.

Step 3: In the real-time monitoring interface, events are generated, and data are displayed correctly, which represents the completion of epidemic prevention management business configuration, as shown in Figure 13-4.

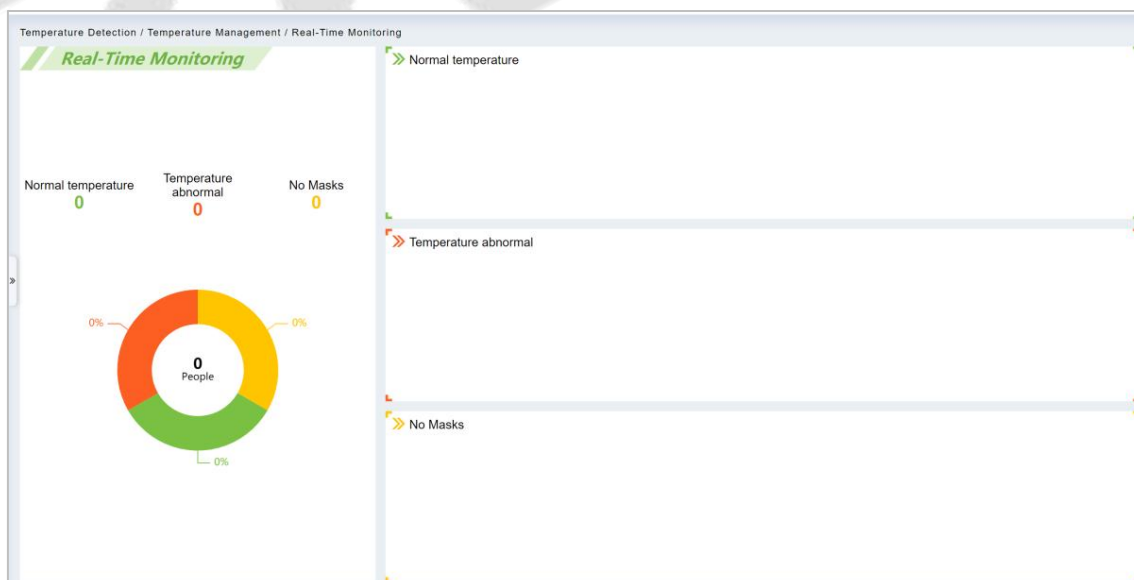

Figure 13-4 Real-Time Monitoring Interface for Epidemic Prevention

13.4 Temperature Management

13.4.1 Real-Time Monitoring

Click **Temperature Detection > Temperature Management > Real-Time Monitoring**.

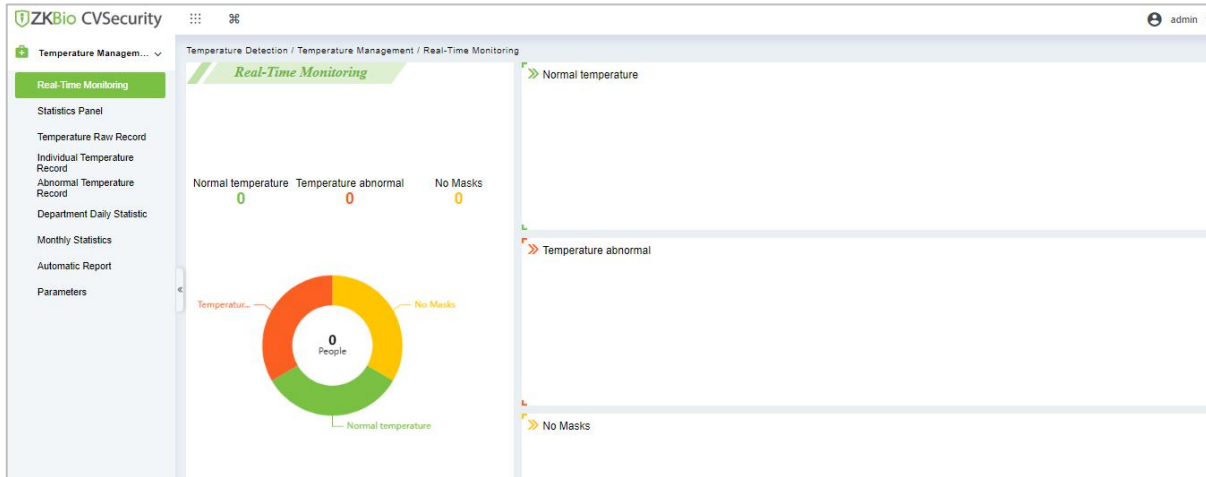

Figure 13-5 Real-Time Monitoring

The Real-Time Monitoring interface allows the user to monitor the body temperature of the users with their image captured during verification. The mask and temperature data are collected at every entry and exit point of the premises if the personnel are registered in the device. The data will be cleared every time after being refreshed or the page is loaded. There are 3 different categories of records that are displayed on the monitoring page. They are:

- Personnel with **Normal temperature** (masked or unmasked).
- Personnel with Temperature abnormal.
- Personnel with **No Mask**.

13.4.2 Statistic Panel

Click **Temperature Detection > Temperature Management > Statistic Panel**.

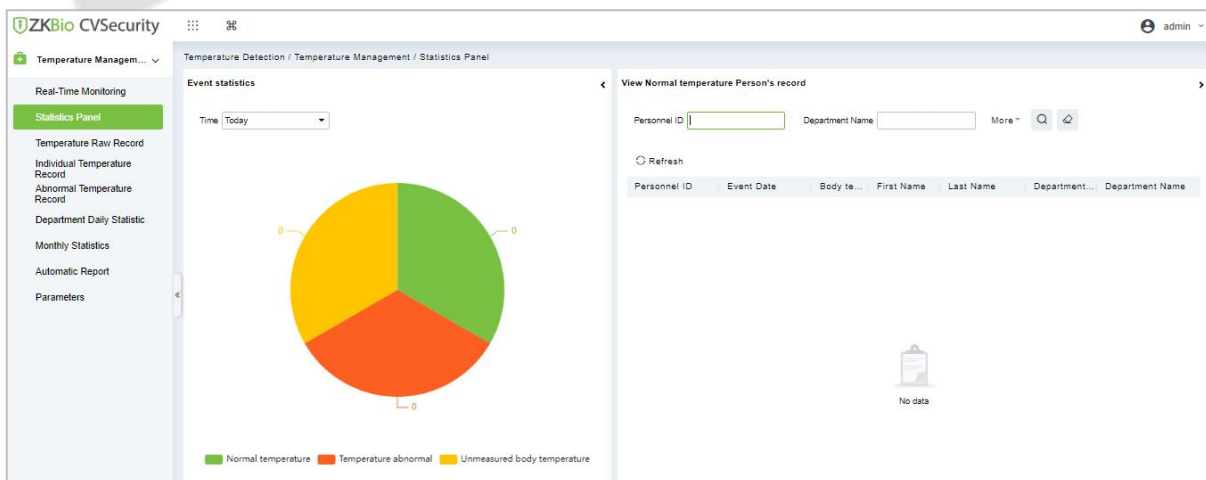

Figure 13-6 Statistic Panel

The statistics panel provides statistical data for the Administrators to analyze the number of users with normal body temperature, abnormal temperature, and unmeasured body temperature in a specific

time period. The statistics can be filtered by time i.e., Today, This Week, and This Month.

You can also click on any category on the Pie-chart and the corresponding personnel details will be displayed on the right side of the interface. Also, personnel can be searched by entering the Personnel ID or Department Name on the top-right corner of the interface. Click **More > Person Type > Choose Personnel/Visitor**.

Parameters	Description
Personnel ID	The default maximum length of personnel ID is 9, and the effective range is 1-799999999, which can be configured according to the actual situation. Value sources Personnel field, cannot be added, modified, or deleted.
Event Date	It displays the date of the Event.
Body Temperature	The "Original body temperature" is usually measured by the device, and it can't be modified. But the "Body Temperature" can be revised in the "Abnormal Temperature Record".
First Name/Last Name	The maximum length cannot exceed 50, does not support comma; value sources Personnel field, cannot add, modify, delete.
Department Number	Letters and numbers are available. It cannot be identical to the number of another department. The number shall not exceed 30 digits.
Department Name	Any combination of a maximum of 100 characters. In the case of different levels, the department names can be repeated.

Table 13-2 Statistic Panel

Note: The statistics are only available for system personnel.

13.4.3 Temperature Raw Record

Click **Temperature Detection > Temperature Management > Temperature Raw Record**.

The **Temperature Raw Record** displays the reports in event-time order that is sequential as it happens regardless of the Normal

Temperature/Abnormal Temperature /Department/Masked/Unmasked. It also displays the Department Name, Body Temperature, Status, and Photo which a user can check instantly after verification.

Export:

Step 1: Click **Export**.

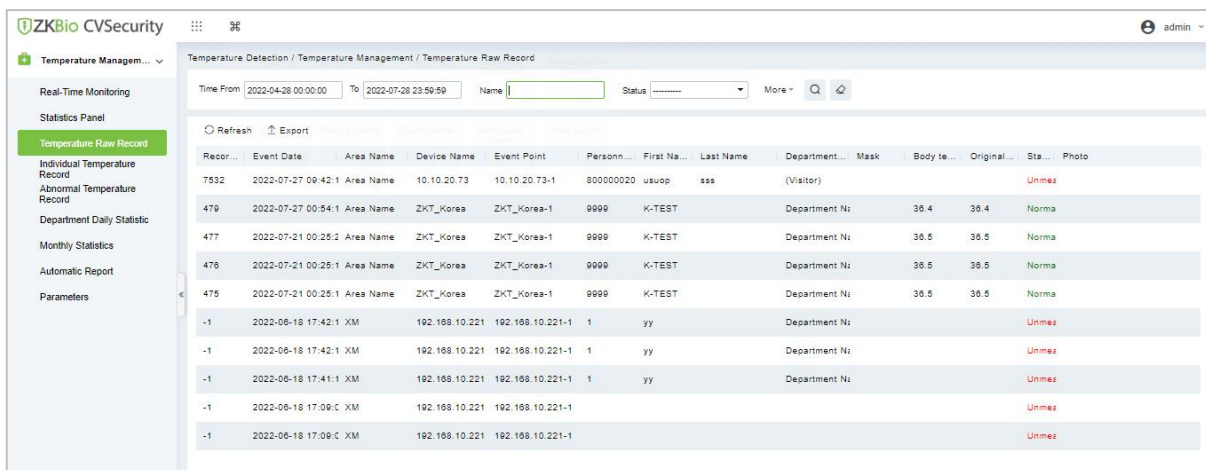

Figure 13-7 Export Temperature Raw Record

Step 2: Select the file format and export mode to be exported. Click **OK**.

Step 3: You can view the file on your local drive.

Note: 10000 records are allowed to export by default, you can manually input them as required.

Parameters	Description
Time	It Displays the Time.
Name	Required Name of the person.
Status	It can enable or disable the charging standard.
Area Name	The name of the area the entry place belongs to, and the registration record for each entry place is filtered according to the area of the entry place.
Device Name	Time and attendance device name, any character up to 20.
Personnel ID	The default maximum length of personnel ID is 9, and the effective range is 1-799999999, which can be configured according to the actual situation. Value sources Personnel field, cannot be added, modified, or deleted.
Department Name	Obtained automatically based on Personnel ID.
Mask	It displays whether mask or no mask.

Table 13-3 Export Temperature Raw Record

Click the **IMAGE** icon to view the captured photo.

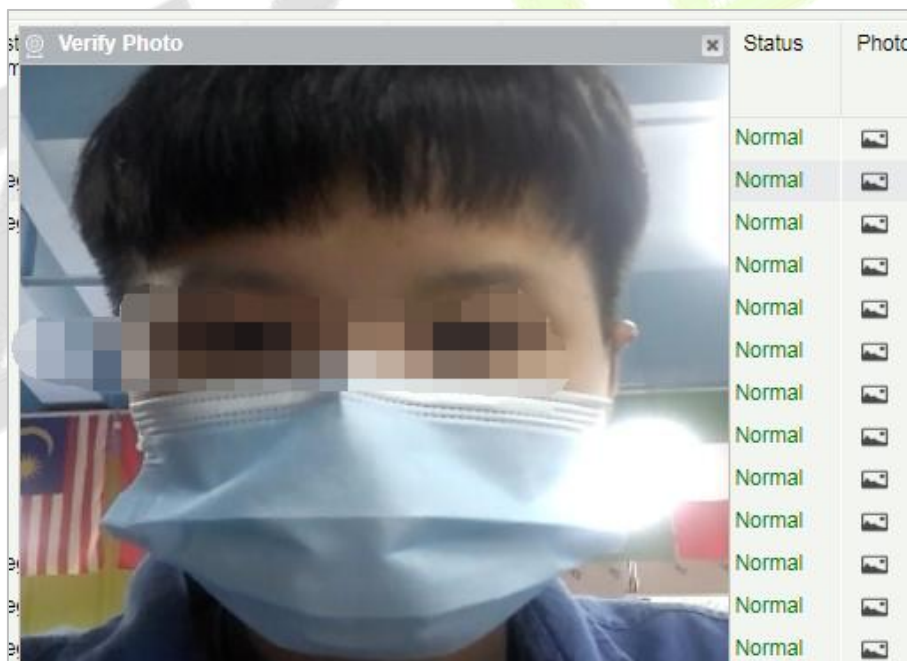

Figure 13-8 Capture Photo

Temperature+Raw+Record												
Record number	Event Date	Area Name	Device Name	Event Point	Personnel ID	First Name	Last Name	Department Name	Mask	Body temperature	Original body temperature	Status
3772	2020-07-01 14:12:04	Area Name	192.168.214.249防疫	192.168.214.249-1	4146	六六的	lulu1	Department Name	Yes	37.0	37.0	Normal
3771	2020-07-01 14:12:02	Area Name	192.168.214.249防疫	192.168.214.249-1	4146	六六的	lulu1	Department Name	Yes	36.9	36.9	Normal
3764	2020-07-01 14:06:23	Area Name	192.168.214.249防疫	192.168.214.249-1	4146	六六的	lulu1	Department Name	Yes	36.7	36.7	Normal
3763	2020-07-01 14:06:21	Area Name	192.168.214.249防疫	192.168.214.249-1	4146	六六的	lulu1	Department Name	Yes	36.8	36.8	Normal
3761	2020-07-01 14:06:18	Area Name	192.168.214.249防疫	192.168.214.249-1	4146	六六的	lulu1	Department Name	Yes	36.7	36.7	Normal
3760	2020-07-01 14:06:10	Area Name	192.168.214.249防疫	192.168.214.249-1	4146	六六的	lulu1	Department Name	None	36.9	36.9	Normal
3759	2020-07-01 14:06:08	Area Name	192.168.214.249防疫	192.168.214.249-1	4146	六六的	lulu1	Department Name	None	36.9	36.9	Normal
3758	2020-07-01 14:06:06	Area Name	192.168.214.249防疫	192.168.214.249-1	4146	六六的	lulu1	Department Name	None	37.2	37.2	Normal
3751	2020-07-01 14:05:32	Area Name	192.168.214.249防疫	192.168.214.249-1	4146	六六的	lulu1	Department Name	Yes	36.5	36.5	Normal

Figure 13-9 Export Temperature Raw Record

Note:

If the Personnel ID field is blank, it represents a Visitor.

The "Original body temperature" is usually measured by the device, and it can't be modified. But the "Body Temperature" can be revised in the "Abnormal Temperature Record".

13.4.4 Individual Temperature Record

This report displays all the body temperature details of a User or Personnel daily.

Export:

Step 1: Click Export:

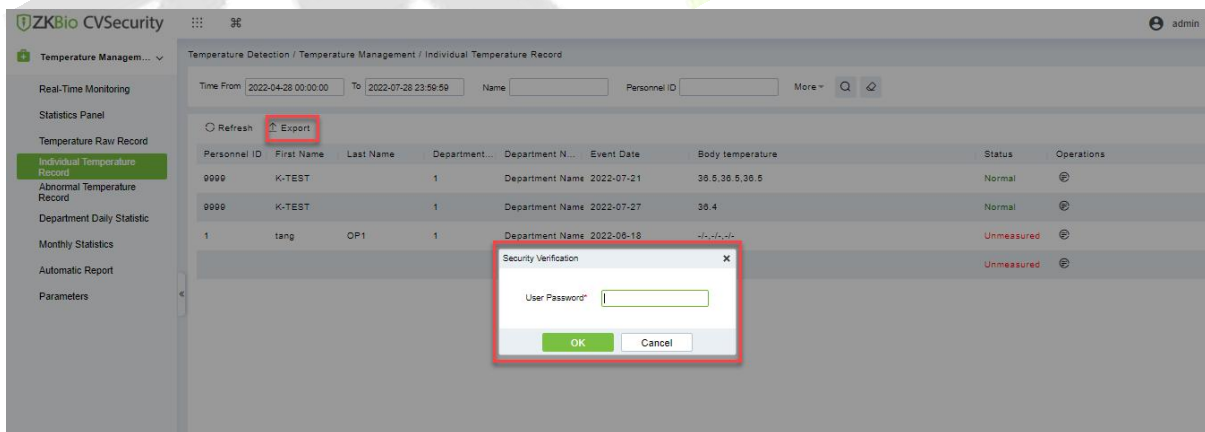

Figure 13-10 Individual Temperature Record

Step 2: Select the file format and export mode to be exported. Click **OK**.

Step 3: You can view the only in your local drive.

Note:

10000 records are allowed to export by default, you can install manually them input as required.

Click **Body Temperature** to view the details of each record.

13.4.5 Abnormal Temperature Record

It displays the record of exceptional body temperatures i.e., above the body temperature threshold and the temperature of personnel that is not detected.

Click **Temperature Detection > Temperature Management > Abnormal Temperature Record**.

Export:

Step 1: Click **Export**.

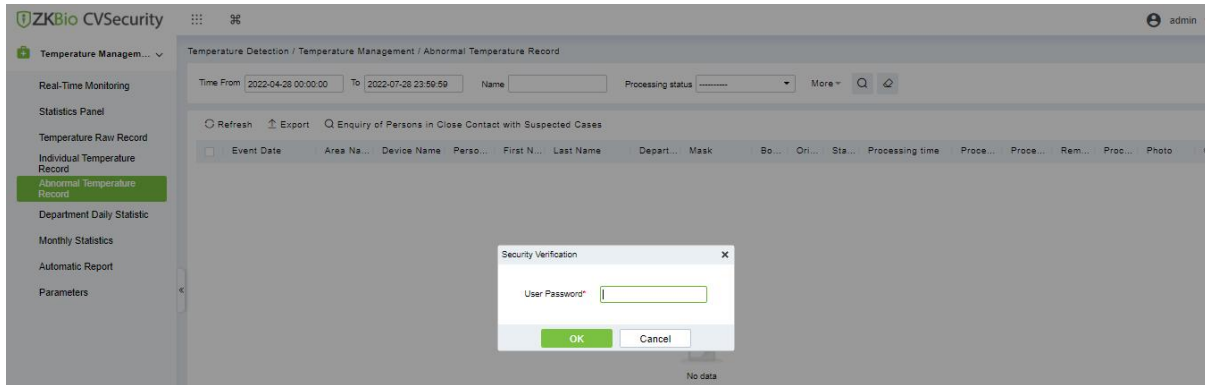

Figure 13-11 Abnormal Temperature Record

Step 2: Select the file format and export mode to be exported. Click **OK**.

Step 3: You can view the file on your local drive.

Note: 10000 records are allowed to export by default, you can manually input them as required.

Edit:

Click the **Edit** option to revise the user’s body temperature by manual detection. The edit window pops up as shown below:

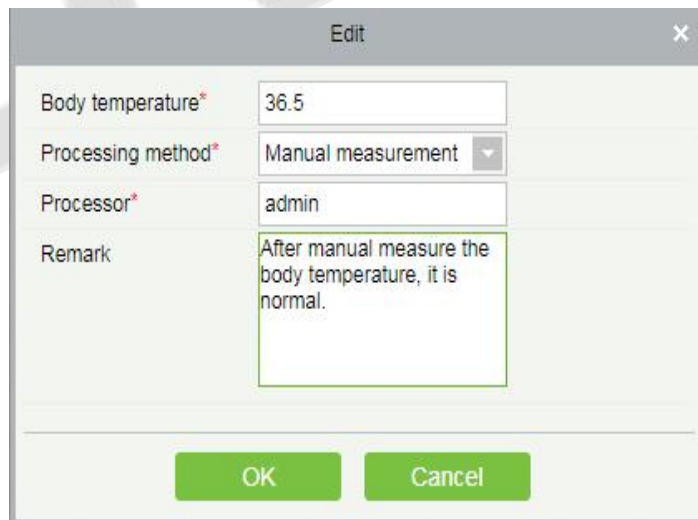

Figure 13-12 Edit Temperature Record

Enquiry of Persons in Close Contact with Suspected Cases:

It will help the user to check the personnel who had contact with any suspected persons. Enter the contact time, 1 to 120 minutes is applicable.

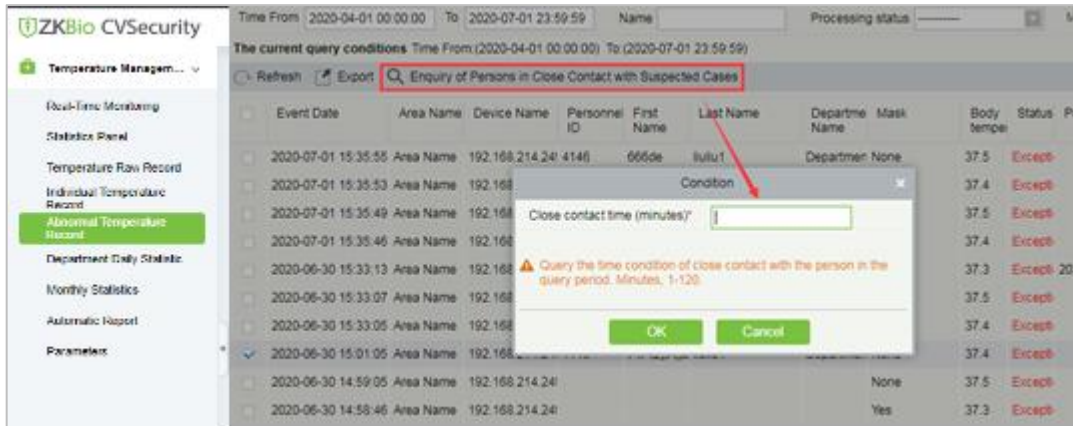

Figure 13-13 Enquiry of Person in Close Contact with Suspected Cases

Click **OK** to view the search results.

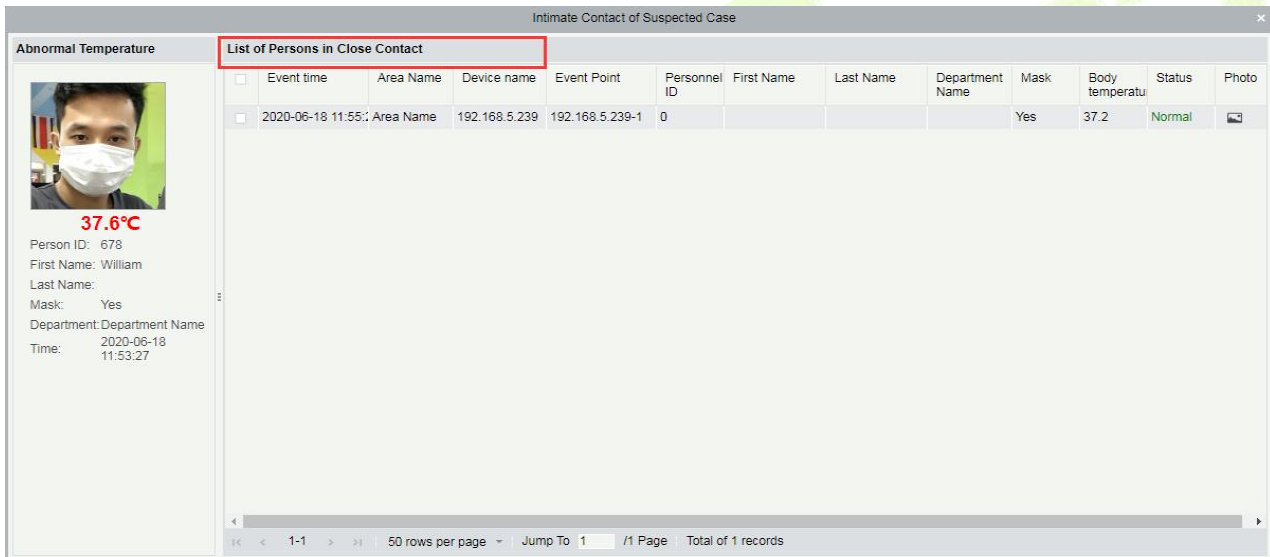

Figure 13-14 List of Person

13.4.6 Department Daily Statistics

It displays the department-wise temperature detection records. A user can select a department from the list of departments in the left panel which displays the number of persons with normal temperature, abnormal temperature, and unmeasured in the specific department daily. It also displays the proportion of abnormal body temperature.

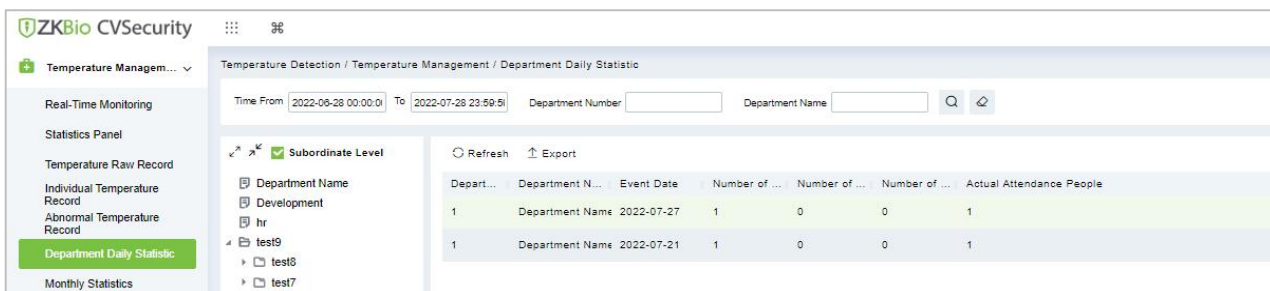

Figure 13-15 Department Daily Statistics

Export:

Step 1: Click Export.

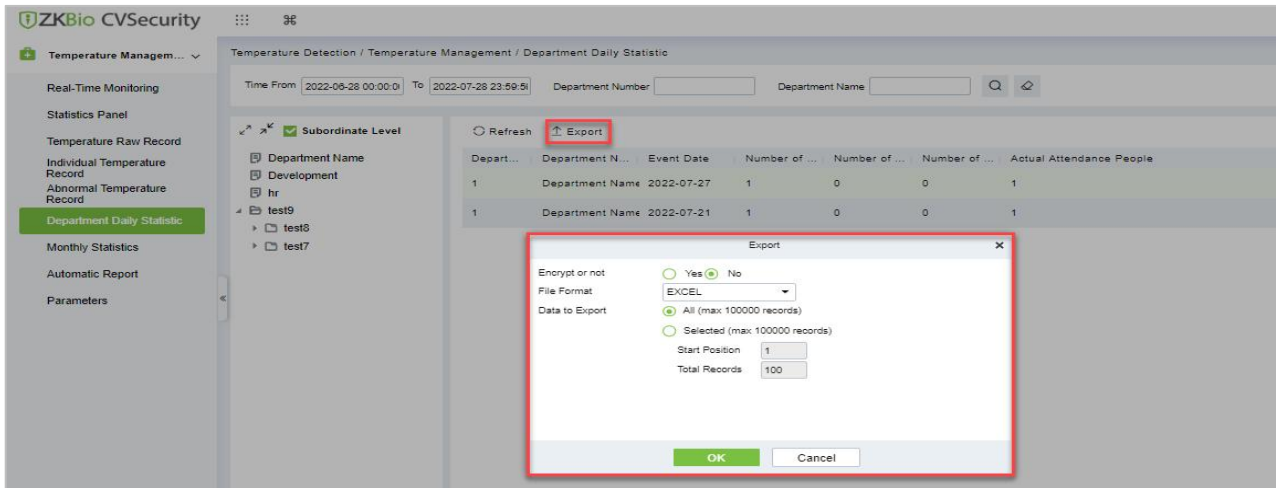

Figure 13-16 Export

Step 2: Select the file format and export mode to be exported. Click **OK**.

Step 3: You can view the file on your local drive.

Note: 10000 records are allowed to export by default, you can manually input them as required.

Parameters	Description
Department Number	Letters and numbers are available. It cannot be identical to the number of another department. The number shall not exceed 30 digits.
Department Name	Obtained automatically based on Personnel ID.
Event Date	It displays the date of Event.
Number of Abnormal Temperatures	It displays the number of normal temperatures.
Number of Normal Temperatures	It displays the number of normal temperatures.
Number of Unmeasured	It displays the number of unmeasured.
Actual Attendance People	It displays the Attendance of people.

Table 13-4 Export

13.4.7 Monthly Statistics

Click **Temperature Detection > Temperature Management > Monthly Statistic** to view the infographics of monthly temperature detection.

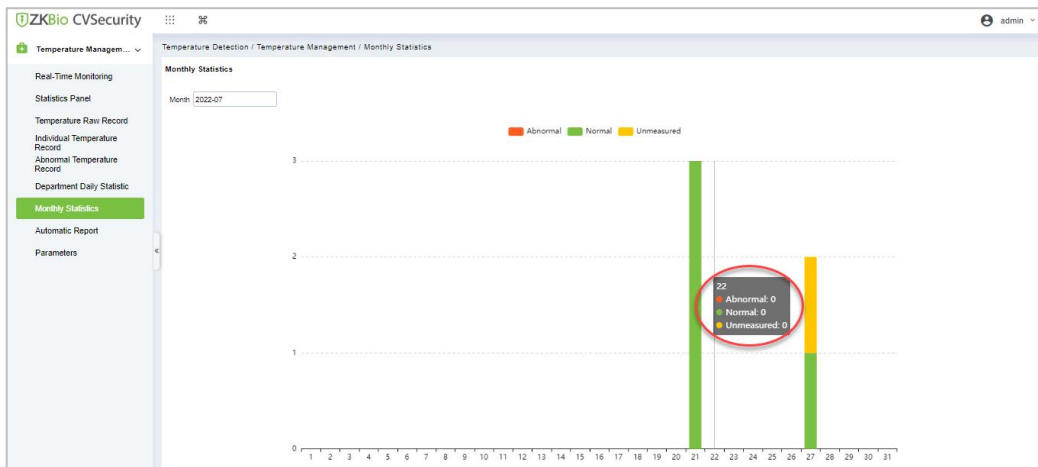

Figure 13-17 Monthly Statistics

13.4.8 Automatic Report

The Automatic reporting feature helps you to send the reports to the designated person at the specified time.

Click **Temperature Detection > Temperature Management > Automatic Report**.

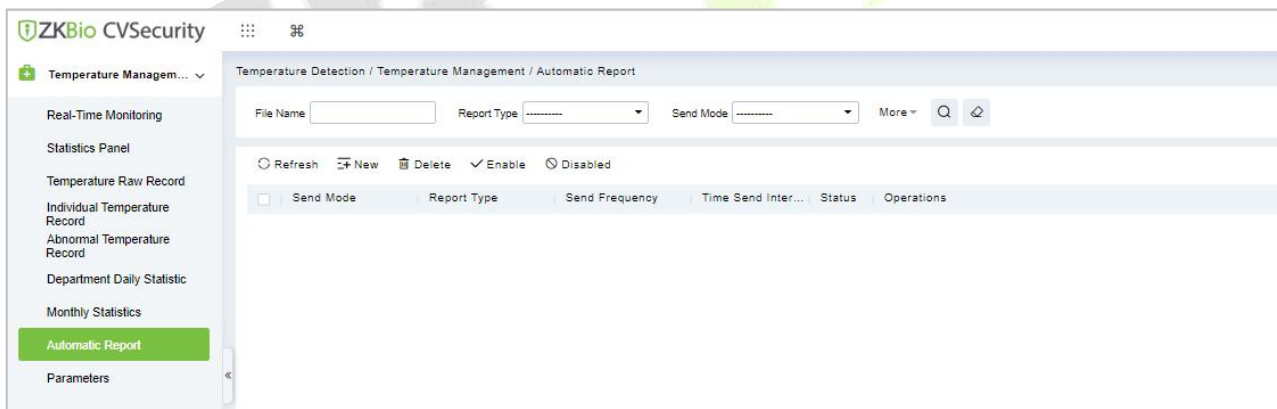

Figure 13-18 Automatic Report

13.4.8.1 Delete

Select File name in the list on the right and click **Delete**.

13.4.8.2 Enable/Disable

Select device, click **Enable/Disable** to stop/start using the device. When communication between the device and the system is interrupted or device fails, the device may automatically appear in disabled status. After adjusting local network or device, click **Enable** to reconnect the device and restore device communication.

13.4.8.3 New

Click the **New** button to open the adding automatic export page.

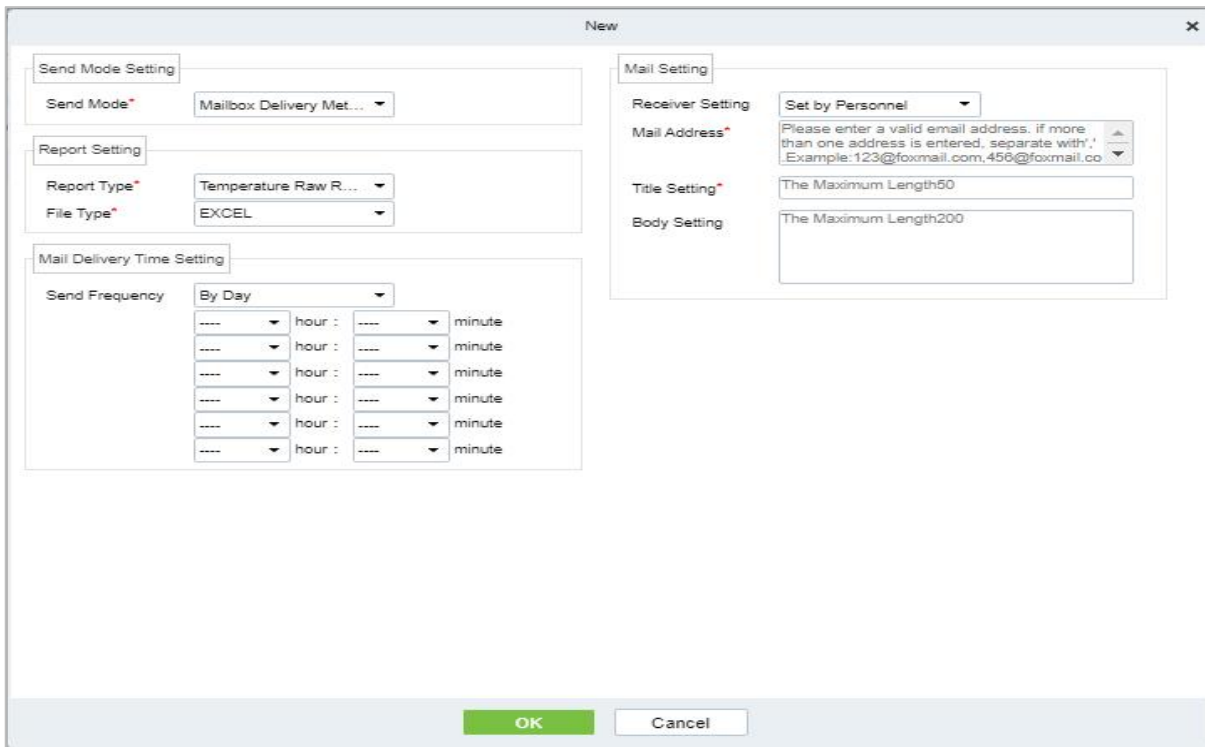

Figure 13-19 Add Automatic New report Interface Page

- **Send Mode Setting**

Send Mode: The reports can be sent through Email or FTP.

- **Report Setting:**

Report Type: The report types that can be sent are Transactions or Daily Attendance.

File Name: The File Name is composed of three parts: Custom file name + YYMMDD + HHMMSS (For example, Test Department Transactions 201911011143).

The first text box is for the custom file name.

The second drop-down box is to select the Day/Month/Year format: yyyyymmdd and yyyy-mm-dd are currently supported.

The third drop-down box is to select the Hour/Minute/Second format: HHmmss is currently supported.

Parameters	Description
Field	It displays the field name and field number of the currently selected report
File Type	It currently supports EXCEL, TXT.
Content Format	Exports the content format of the attached report, such as {department Name}, {department Name}, {person Pin}, {person Name}, {devices}, {device Name}, {area Name}, {add Date time}. You cannot delete the content format when the file type is EXCEL; When the File type is TXT, the content format is editable.
Sending Frequency	The report sending frequency can be a day or by month.
By Day	It supports up to 6-time points per day and can only be sent once per hour. Set the Hour and Minute to send the report from the drop-down boxes

Table 13-5 Export

The screenshot shows a 'Mail Delivery Time Setting' window. Under 'Send Frequency', the 'By Day' option is selected. Below this, there is a grid of six rows and two columns of dropdown menus. Each row contains a dropdown for 'hour' followed by a colon and a dropdown for 'minute'. All dropdowns are currently set to '----'.

Figure 13-20 Report Setting

By Month: It supports Support last day, first day, and a specific date of each month.

The screenshot shows the 'Mail Delivery Time Setting' window with 'By Month' selected. There are three radio button options: 'Last day of the month', 'First day of the month', and 'Specific Date'. The 'Specific Date' option is selected, and it includes a date input field showing '--' and a range '(1-28)'.

Figure 13-21 Report Setting

Mail Setting: Mail setting is required when the sending mode is Mailbox Delivery Method.

Parameters	Description
Receiver Setting	You can select the recipient by person, department, or area.
Set by Personnel-Email Address	Enter the valid Email Address of the recipient. If there are multiple recipients, then the Email address can be separated by a semicolon.
Set by Department	Select a department in the department tree diagram and the report will be sent to all the persons whose Email Addresses are configured under the department.
Set by area-Attendance area	Select an area in the area tree, and the report will be sent to all the persons whose Email Addresses are configured under the area.
Title Setting	The Maximum length of the report title is 50 characters.
Title Setting	The Maximum length of the message content is 200 characters

Table 13-6 Mail Setting

13.4.9 Parameters

It allows the user to set the body temperature threshold which determines the category to which the recorded temperature falls-in i.e., Abnormal Temperature or Normal Temperature. For example, assume that the threshold temperature is set to 37.3^oC. If the recorded temperature is 37^oC, it will be saved as “Normal Temperature” and if the recorded temperature is 38^oC, it will be saved as “Abnormal Temperature”. The temperature unit can also be chosen between ^oC and ^oF.

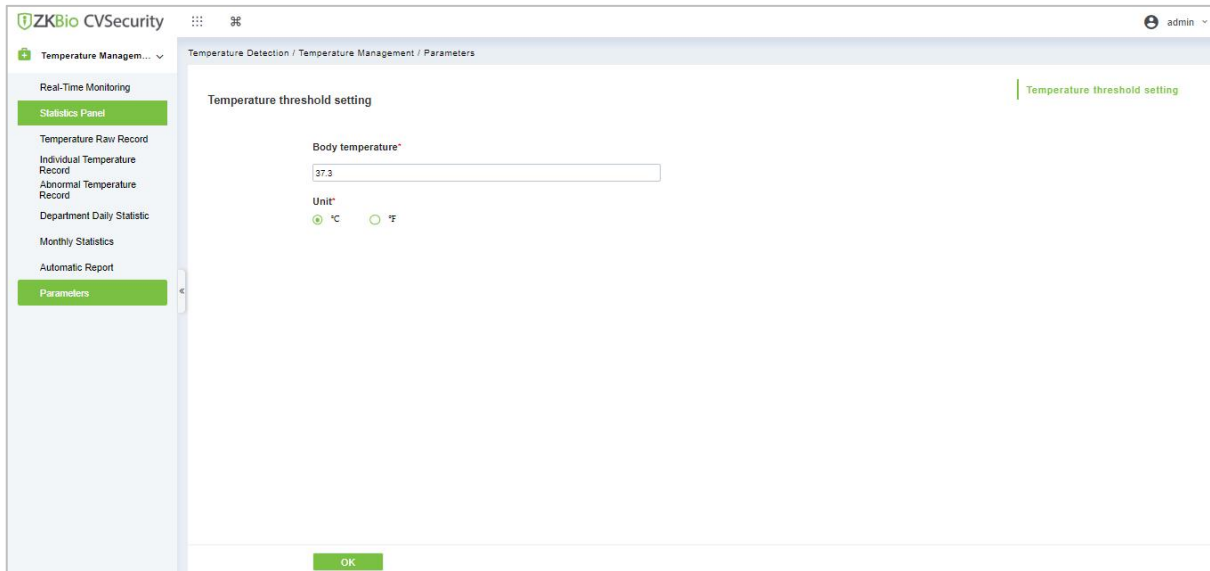

Figure 13-22 Parameters

Note:

After setting the body temperature threshold, the Real-Time Monitoring Page will refresh, and the persons will be categorized according to the new threshold temperature.

The value is rounded off to one decimal place.

14 Service Center

This module integrates the device and event logging of the system module. Users can import a map to the map center to view the distribution of monitoring points and alarm sources. When an alarm occurs, users can view the location and surrounding conditions of the alarm source, select a suitable monitoring point, and view video live, playback, and human movement functions.

14.1 Device Center

14.1.1 Device

Devices added to the access control and video module are displayed on the screen, and basic device information is displayed, as shown in Figure 14-1.



Service Center / Device Center / Device

Device Name 🔍 ↻

🔄 Refresh 🔄 Device synchronization

Serial Number	Device Name	Device Model	Firmware V...	IP Address	Belong Areas	Source Mo...	Status	Operator
CN3M212460001	ProfaceX	TDB08M-TI/M	ZAM170-NF-Vi	192.168.134.168	Area Name	Access	🔴	🔄
21024127099SL8000137	192.168.134.59	DBL522-01		192.168.134.59	Area Name	Intelligent Vid	🔴	🔄
f673eae8ab854805b3874535b6b56	AS1700	IVS1800		192.168.134.101		Intelligent Vid	🟢	🔄

Figure 14- 1 Device Display Page

Device Synchronization:

Synchronize data of the system to the device. Select device, click Synchronize Data to Devices and click OK to complete synchronization.

Note: Synchronize Data to Devices will delete all data in the device first (except transactions), and thus download all settings again. Please keep the internet connection stable and avoid power down situations. If the device is working normally, please use this function with caution. Execute it in rare user situations to avoid impact on normal use of the device.

14.2 Event Center

Through the definition of the event level and type, it makes the level prompt for the record generated under real-time monitoring.

14.2.1 The Event Type

The software contains event types by default. You cannot add new event types. You can customize the level of the event type.

This section describes how to modify Step.

● Modify Event Type

Operation Step:

Step 1: In the **Service Center** module, choose **Event Center > Event Type**.

Step 2: On the **Event Type** page, select the event type to be modified and click **Event Level**. The Event Level dialog box is displayed.

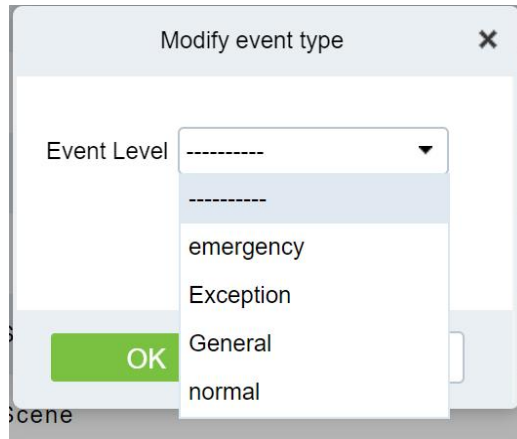

Figure 14- 2 Modify Event Level Page

Step 3: After selecting the desired level, Click **OK** to complete changing the event type level.

14.2.2 The Event Record

This screen records all events generated on the platform, as shown in Figure 14-4.

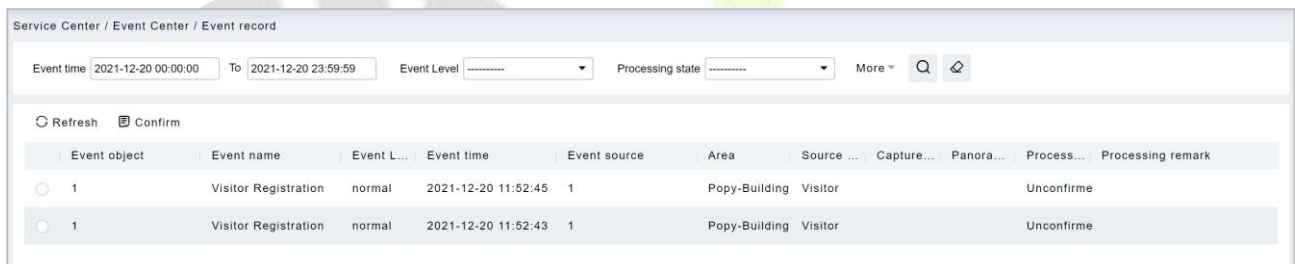

Figure 14- 3 Event Recording Page

14.3 Notification Center

Notification Record

This interface records the notification reminding events generated by the attendance and visitor module.

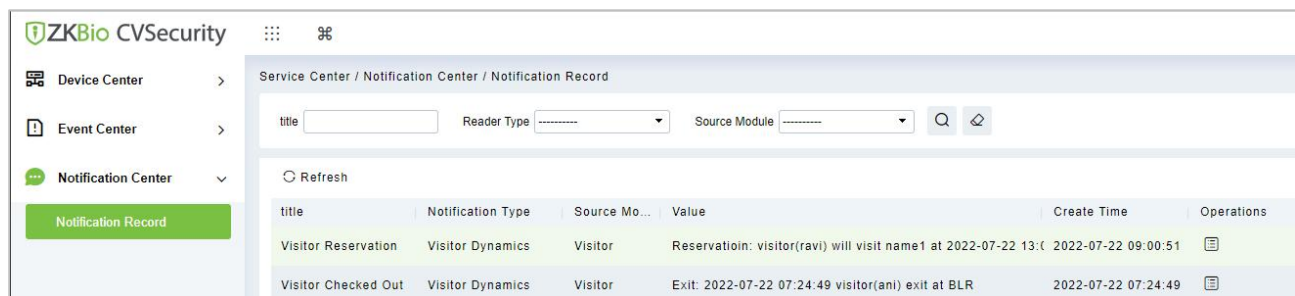

Figure 14- 4 Notification Record Page

14.4 The Map Center

You can import a map to set monitoring points. When an alarm occurs, you can immediately view the location of the alarm source and surrounding conditions, select an appropriate monitoring point, and view live videos, playback, and personnel movements.

14.4.1 Real-Time Monitoring

Alarms generated in the access control and video modules are displayed on the real-time monitoring interface. You can query access control and video events by category. When an alarm is generated, you can view the location of the alarm source and surrounding conditions, select a suitable monitoring point, and view the live video, playback, and personnel movement. Operation that can handle doors in batches.

14.4.1.1 Personnel Movement

This paper introduces the configuration Step for real-time monitoring of personnel movement in the service center module.

Operation Step

Step 1: In the **Service Center** module, choose "**Map Center > Real-time Monitoring**".

Step 2: On the real-time monitoring screen, click the icon on the right  in the personnel Trend window that is displayed, set related parameters.

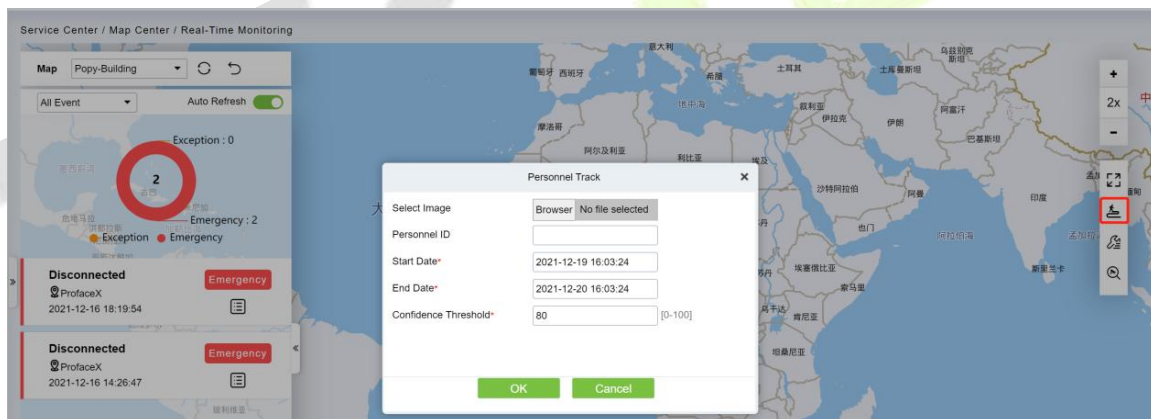

Figure 14- 5 Page for Querying Personnel Trends

Step 3: Click **OK** to display the movement chart on the map.

14.4.1.2 Batch operation

This paper introduces the configuration Step for real-time monitoring of batch operation in the service center module.

Operation Step:

Step 1: In the **Service Center** module, choose "**Map Center > Real-time Monitoring**".

Step 2: On the real-time monitoring screen, click the icon on the right  In the personnel Trend window that is displayed, set related parameters,

Remote Opening / Remote Closing:

It can control one door or all doors.

To control a single door, right click over it, and click **Remote Opening/ Closing** in the pop-up dialog

box. To control all doors, directly click **Remote Opening/ Closing** behind Current All.

In remote opening, user can define the door opening duration (The default is 15s). You can select **Enable Intraday Passage Mode Time Zone** to enable the intraday door passage mode time zones, or set the door to Normal Open, then the door will not be limited to any time zones (open for 24 hours).

To close a door, select **Disable Intraday Passage Mode Time Zone** first, to avoid enabling other normal open time zones to open the door, and then select **Remote Closing**.

⚡➤ **Note:** If **Remote Opening /Closing** fails, check whether the devices are disconnected or not. If disconnected, check the network.

Activate Lockdown:

It will remotely set the door status to locked status. After this, the door wouldn't receive any operations, such as card reading and remote operations. This function is supported only by certain devices.

Deactivate Lockdown:

It will unlock a locked door. This function is supported only by certain devices.

Cancel Alarm:

Once an alarming door is displayed on the interface, the alarm sound will be played. Alarm cancellation can be done for single door and all doors. To control a single door, move the cursor over the door icon, a menu will pop-up, then click **Remote Opening/Closing** in the menu. To control all doors, directly click **Remote Opening/Closing** behind Current All.

⚡➤ **Note:** If cancel the alarm fails, check if any devices are disconnected. If found disconnected, check the network.

Remote Normally Open:

It will set the device as normal open by remote

14.4.1.3 Search Device

This paper introduces the configuration Step for real-time monitoring of search device in the service center module.

● Add a Door

This paper introduces the configuration Step of map configuration and door addition in the service center module.

Operation Step:

Step 1: In the service Center module, choose "**Map Center > Map Configuration**".

Step 2: On the map configuration screen, select the map of the desired area and click on the right of the screen  To add the gate.

Step 3: In the Add Door list on the left of the page, drag the required **Access Control** device to place it on the map,

Step 4: Click **Submit** under the left door bar to complete the operation of adding a door on the map.

● Adding a Camera

This section describes how to add camera Step for map configuration in the Service Center module.

Operation Step:

Step 1: In the Service Center module, choose "**Map Center > Map Configuration**".

Step 2: On the map configuration screen, select the map of the desired area and click on the right of the screen to add a camera.

Step 3: In the Add Camera list on the left of the screen drag the required camera device to place it on the map,

- **Others**

This section describes how to add others Step for map configuration in the Service Center module.

Operation Step:

Step 1: In the Service Center module, choose "**Map Center > Real Time Monitoring**".

Step 2: On the map configuration screen, select the map of the desired area and click on the right of the screen to add a Others

Step 3: In the Add Other list on the left of the screen drag the required other device to place it on the map,

- **Map**

Click the Map: It will show the area of the map

- **Defense Area**

It will show the defence area in the map

14.4.1.4 Handle Video Alarm Details

This section describes the Step configuration for handling video alarm event details in the Service Center module.

Operation Step

Step 1: In the **Service Center** module, choose "**Map Center > Real-time Monitoring**".

Step 2: On the real-time monitoring screen, select a video alarm in the left pane and click  To display detailed information. As shown in Figure 14-6.

Instructions:

Function description of the detailed information interface:

1. Preview: Displays the live view of the current video device.
2. Playback: Plays back the records generated by alarm events.
3. Trend: record the corresponding trend record of personnel.
4. Report: You can note the event status.

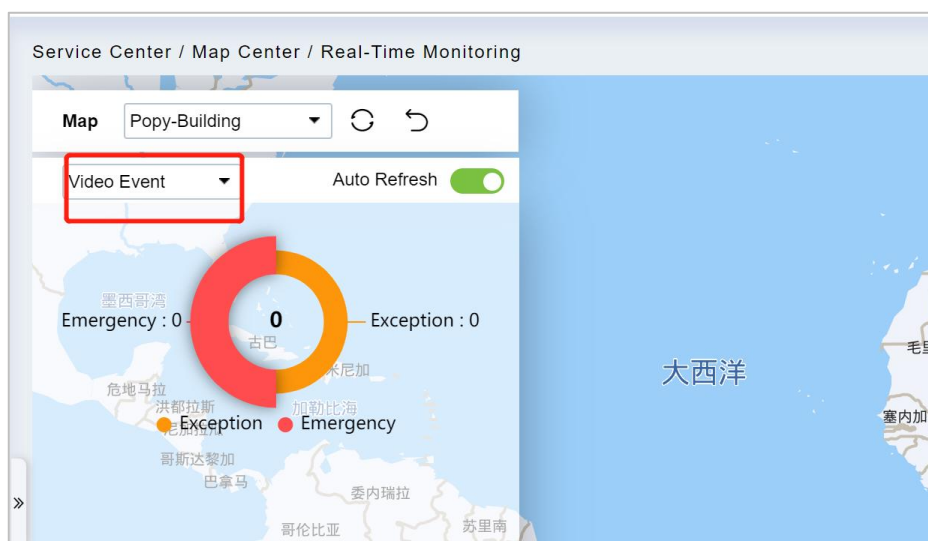

Figure 14- 6 Video Alarm Details Screen

Step 3: After viewing the detailed information and remarks, click **Submit**.

14.4.1.5 Handle Door Alarms in Details

This section describes the Step configuration for handling gate alarm event details in the Service Center module.

Operation Step:

Step 1: In the **Service Center** module, choose "**Map Center > Real-time Monitoring**".

Step 2: On the real-time monitoring page, select the event for which the access control alarm is generated in the left pane and click . The detailed information is displayed.

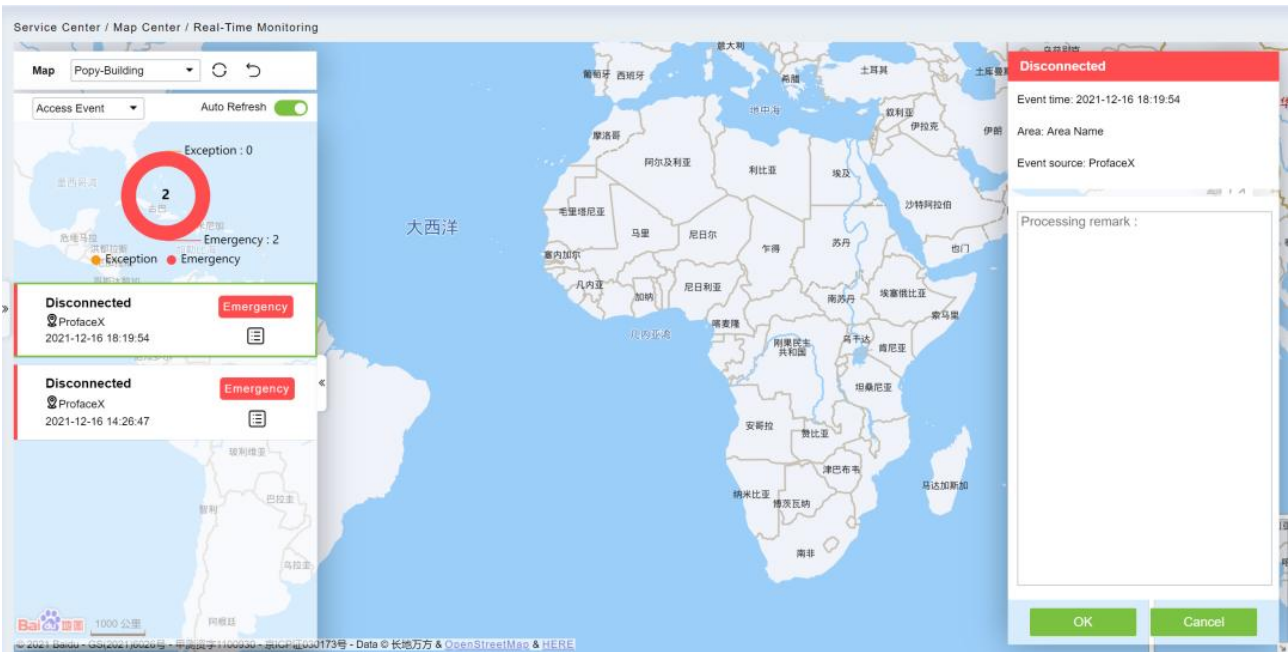

Figure 14- 7 Access Alarm Details Page







Step 3: After filling in the report remarks, click **Submit**.

14.4.2 Map Configuration

By importing the map and configuring the corresponding monitoring points, the distribution of the current monitoring points can be intuitively displayed.

Instructions:

Table 14-1 describes the ICONS on the map configuration page.

Icon	Instructions
	Full screen.
	The refresh.
	Return to the previous level.
	Drag ICONS of Access Control and camera and move coordinates; After Operation is finished, click  , can be saved.
	Add the icon of the Access Control device.

Icon	Instructions
	Add a camera icon.
	Add submaps.
	Operation to zoom in and out of the map.
	Move the mouse over the "door or Video" device on the map and right click it out.
	Add a map.
	The editor.

Table 14-1 Map Configuration Icons

The Premise Conditions:

1. The access control device is added to the **Access Control** module.
2. Add the camera device under the video module.

14.4.2.1 Add a Map

This section describes how to add Step of map configuration in the Service Center module.

Operation Step:

Step 1: In the **Service Center** module, choose "**Map Center > Map Configuration**".

Step 2: In the map configuration screen, click on the left bar . The page for adding a map is displayed, as shown in Figure 14-8. For details about the parameters, see Table 14-2.

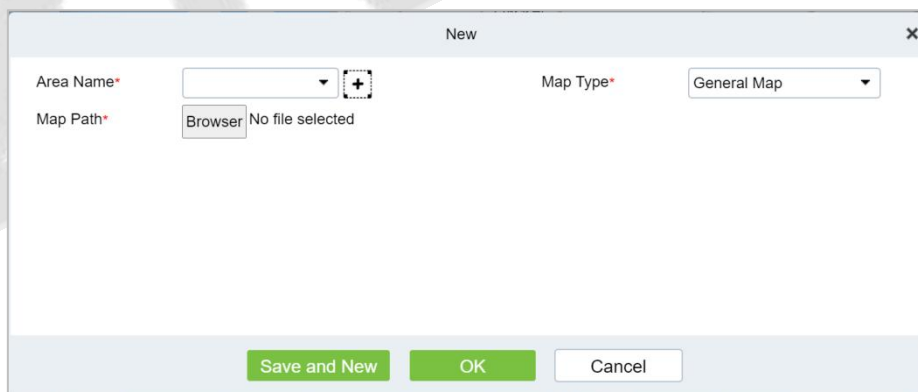

Figure 14- 8 Add Map Page

The Map Type	Parameter	Instructions
Normal Mapping (Using the map drawn by the user, as the background loading,)	Name	Select the area to which you want to add the map. For details about how to configure regions, see 18.2 Region Settings.
	Map Path	Select the map you want to add, that is, the map image file that exists on the local server in advance. Instructions <ul style="list-style-type: none"> • Map is supported formats. Jpe \. JPG \. Jpeg \. GIF \. PNG \. BMP \. Ico \. SVG \. SVGZ \. Tif \. Tiff \. Ai \. DRW \. PCT \. PSP \. XCF \. PSD \. Raw \. Webp image file.

The Map Type	Parameter	Instructions
		<ul style="list-style-type: none"> Map image file size should not exceed 1120 × 380px.
Hypergraph	Name	Select the area to which you want to add the map. For details about how to configure regions, see 18.2 Region Settings.
	Map Path	To set up a GIS server, set parameters on the server, and then set these parameters.
	Route Analysis Path	
	Projection	
	The Center X/Y Coordinate	Fill in the latitude and longitude.
	Initialize The Scaling Level	The general choice for initial scaling is around 13.
	Maximum Zoom Level/Minimum Zoom Level	Custom map zoom size.
Google Maps	Area	Select the area to which you want to add the map. For details about how to configure regions, see 18.2 Region Settings.
	The Map Key	Log on to the platform for https://cloud.google.com/maps-platform for registration for the key. Instructions: You need to turn on the Directions API on Google's platform to map people's movements.
	Initialize The Scaling Level	The general choice for initial scaling is around 13.
	The Center X/Y Coordinate	Fill in the latitude and longitude.
Baidu Map	Area	Select the area to which you want to add the map. For details about how to configure regions, see 18.2 Region Settings.
	The Map Key	Log in to http://lbsyun.baidu.com/ to register and obtain the key.
	Initialize The Scaling Level	The general choice for initial scaling is around 13.
	The Center X/Y Coordinate	Fill in the latitude and longitude.

Table 14-2 Parameters for Adding a Map

Step 3: Set parameters based on the type of the map to be added and Click **OK** to finish adding the map.

14.4.2.2 Add Submap (Optional)

This section describes how to add sub-map configuration Step on the map in the **Service Center** module.

Operation Step:

Step 1: In the **Service Center** module, choose "**Map Center > Map Configuration**".

Step 2: On the map configuration screen, select a region map and click on the right  To add submaps.

Step 3: In the Add Map list on the left of the page, drag a submap to place it on the map.

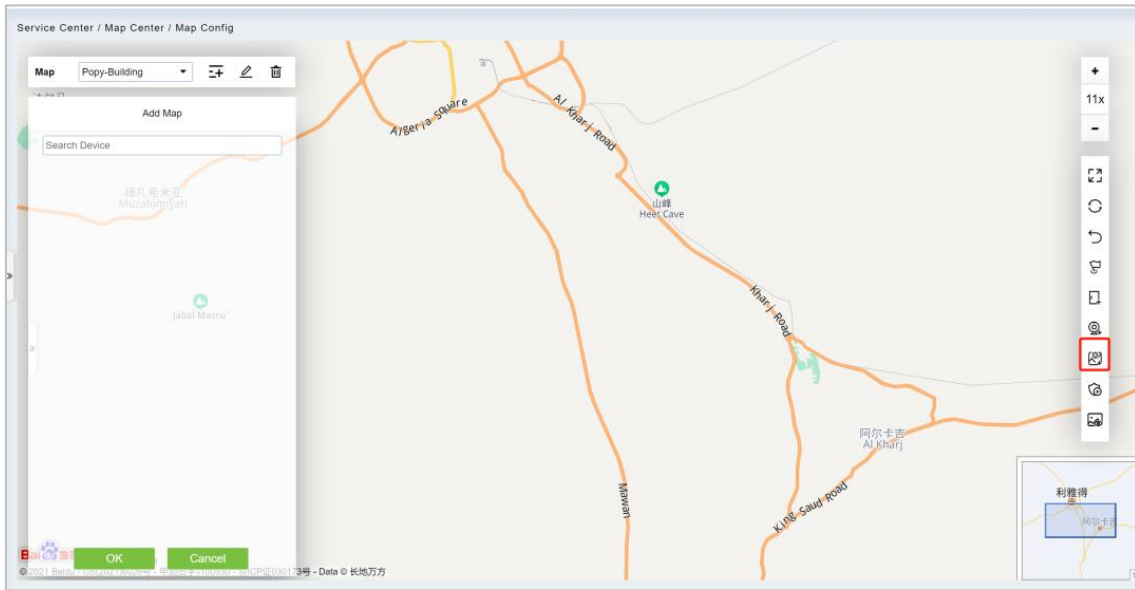

Figure 14- 9 Add Submap Page

Step 3: Click **submit** under add map on the left to complete the configuration of the sub-map.

14.4.2.3 Add a Door

This paper introduces the configuration Step of map configuration and door addition in the service center module.

Operation Step

Step 1: In the service Center module, choose "**Map Center > Map Configuration**".

Step 2: On the map configuration screen, select the map of the desired area and click on the right of the screen  to add the gate.

Step 3: In the Add Door list on the left of the page, drag the required **Access Control** device to place it on the map, as shown in Figure 14-10.

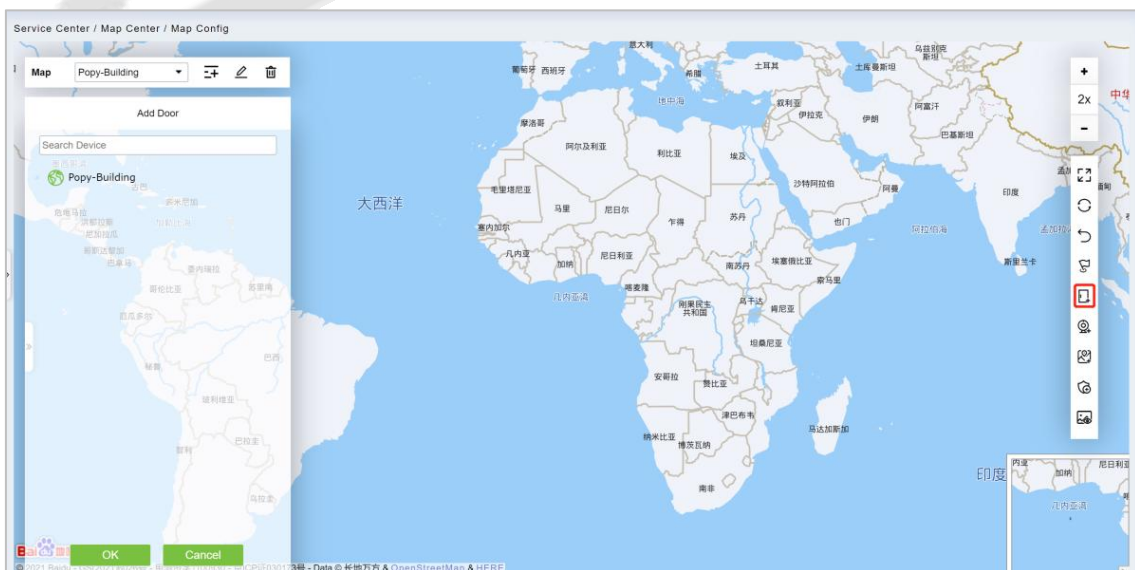

Figure 14- 10 Add Door Page

Step 4: Click **Submit** under the left door bar to complete the operation of adding a door on the map.

14.4.2.4 Adding a Camera

This section describes how to add camera Step for map configuration in the Service Center module.

Operation Step

Step 1: In the **Service Center** module, choose "**Map Center > Map Configuration**".

Step 2: On the map configuration screen, select the map of the desired area and click on the right of the screen  to add a camera.

Step 3: In the Add Camera list on the left of the screen, drag the required camera device to place it on the map, as shown in Figure 14-11.

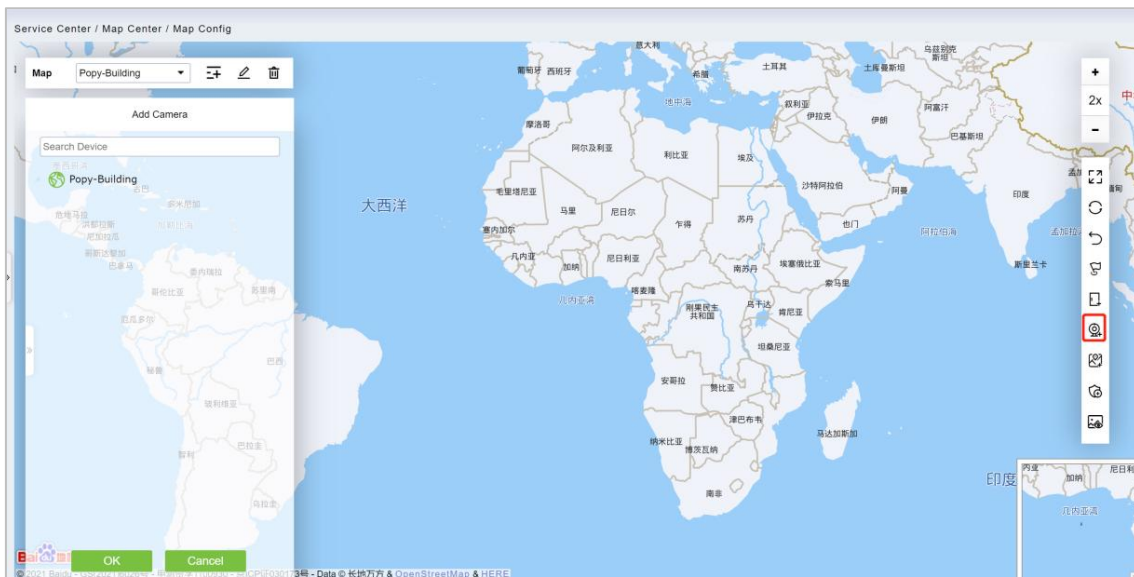

Figure 14- 11 Add Camera Screen

Step 4 Click **Submit** in the left column of Adding a camera to complete the configuration of adding a camera to the map.

14.4.2.5 Add Defence Area

We can view the Intrusion Alarm states in real time through the map center.

Step 1: Go to **Service Center > Map Center > Map Config**. Click , start adding defence area.



Figure 14- 12 Adding Defense Interface

Step 2: Click the **Adding Defence Area** on the left of the screen, drag the required partition or zone to place it on the map.

Step 3: Click **OK** the left column of **Adding Defence Area** to complete the configuration of adding a partition.

14.4.2.6 Map

Click the Map: It will show the area of the map.

14.5 Push Center

14.5.1 Push Configuration

- **Add New**

Operation Step:

Step 1: In the **Service Center** module, choose "**Push Center > Push Configuration**".

Step 2: In the **Push Configuration** interface, click **Add New** and fill in the relevant parameters, as shown in Figure 14-13. Please refer to Table 14-3 for parameter description.

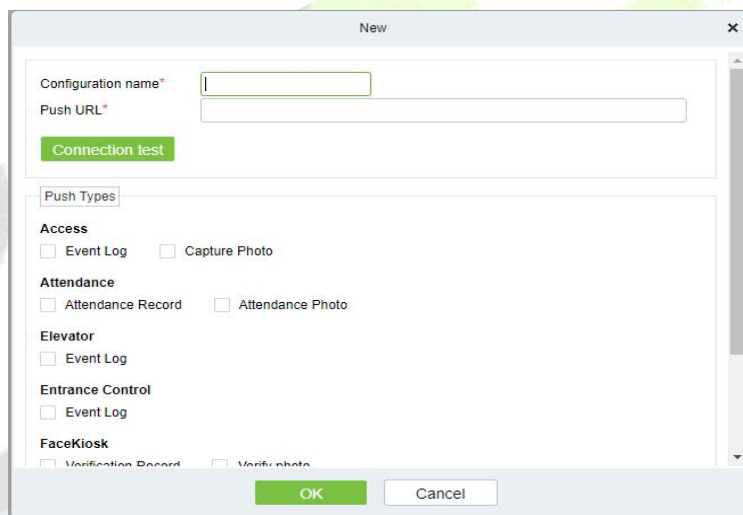

Figure 14- 13 Add Push Configuration

Parameter	Description
Configuration Name	Enter the configuration name
Push URL	Enter the push URL

Table 14-3 Parameters for New

- **Delete**

Select one or more push configuration and click **Delete** at the upper part of the list and click **OK** to delete the selected. push configuration Click **Cancel** to cancel the operation or click **Delete** in the operation column to delete a single push configuration.

- **Docking Example**

It will show the example of data format as a code.

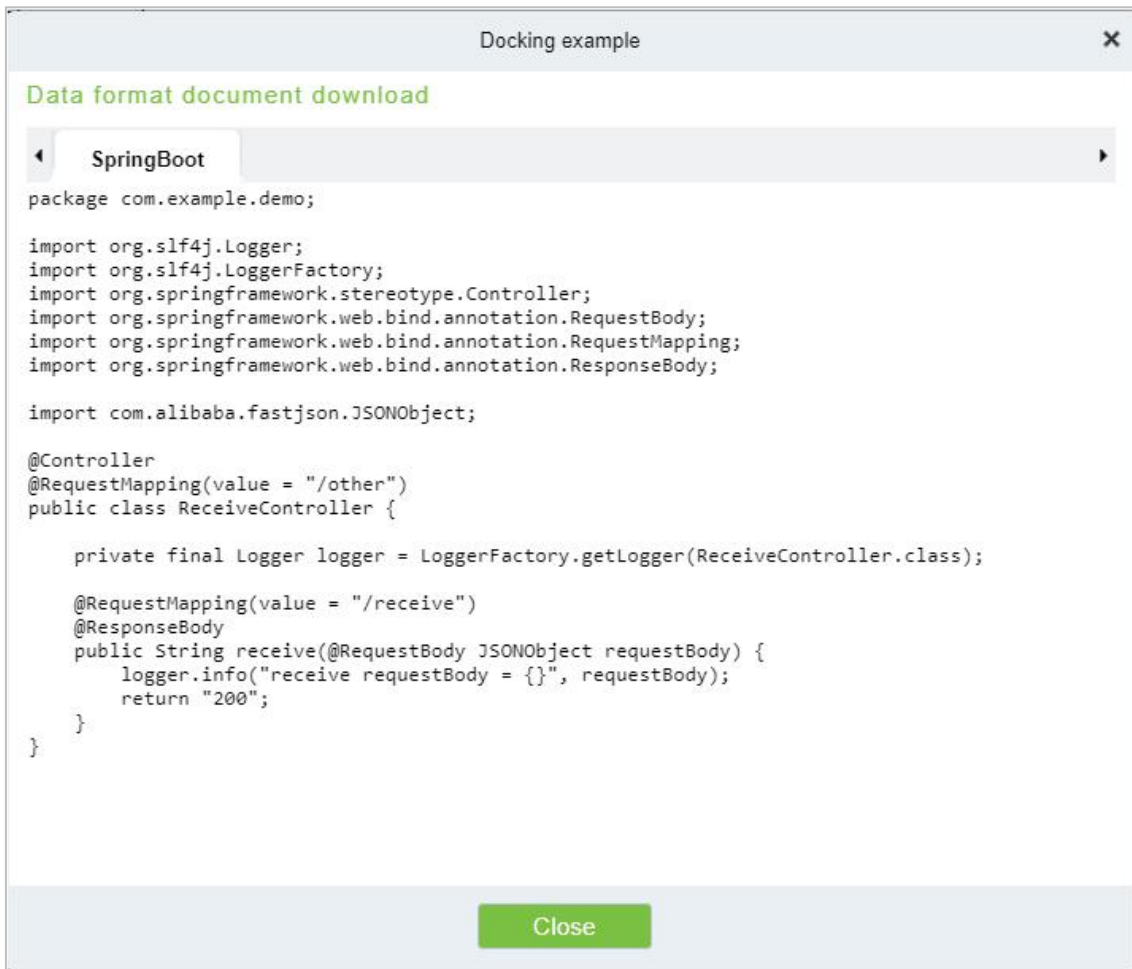

Figure 14- 14 Docking Example

14.5.2 Push Exception Record

- **Delete**

Select one or more push exception record and click **Delete** at the upper part of the list and click **OK** to delete the selected. push exception record Click **Cancel** to cancel the operation or click **Delete** in the operation column to delete a single push exception record.

- **Re-push**

If the data sync failed one time it will re-sync the data automatically to the software and device.

- **Manual Push**

Manual push is we need to sync the data from device to the software.

15 System management

15.1 System Management

System settings primarily include assigning system users (such as company management user, registrar, access control administrator) and configuring the roles of corresponding modules, managing database, setting system parameters and view operation logs, etc

15.1.1 Operation Log

Operation Step

Step 1: Click **System > System Management > Operation Log**.

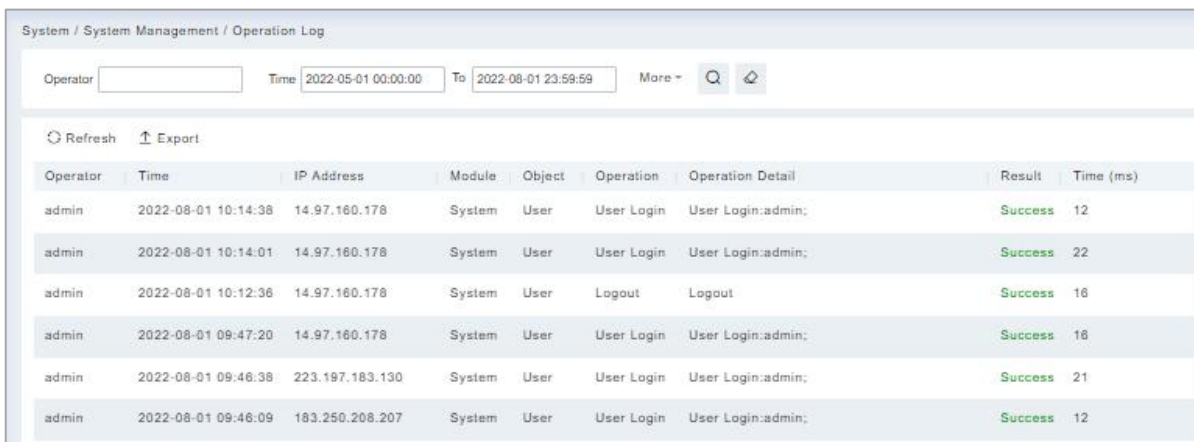

Figure 15-1 Operation Log Interface

All operation logs are displayed in this page. You can query specific logs by conditions.

15.1.1.1 Refresh

Click **Refresh** at the upper part of the list to get the most updated version of the operation log.

15.1.1.2 Export

Export the operation log records, save to local. You can export to an Excel, PDF, TXT or CSV file. See the following figure.

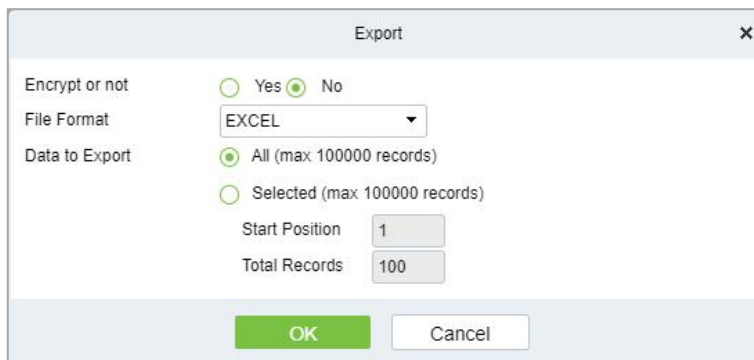

Figure 15-2 Export Option

15.1.2 Database Management

Operation Step

Step 1: Click **System > System Management > Database Management**.

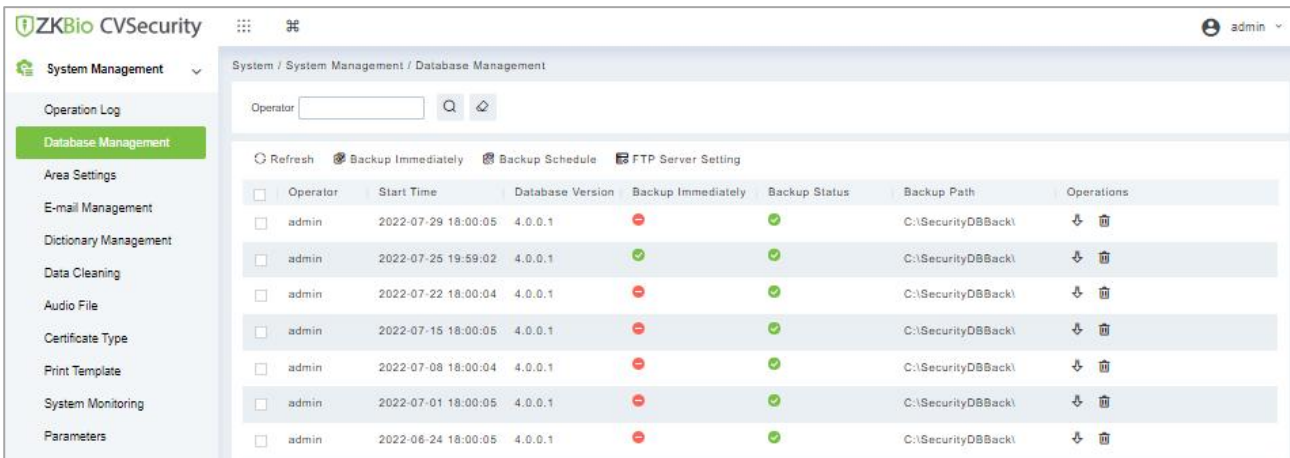

Figure 15-3 Database Management Interface

All history operation logs about database backup are displayed in this page. You can refresh, backup and schedule backup database as required.

15.1.2.1 Refresh

Click **Refresh** at the upper part of the list to get the most updated version of the operation log.

15.1.2.2 Backup Immediately

Step 1: Click **Backup Immediately**.

Backup database to the path set in installation right now.

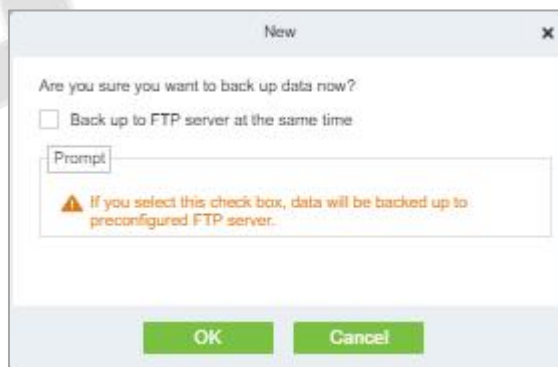

Figure 15-4 Back up Immediately Option

⚠️ **Note:** The default backup path for the system is the path selected during the software installation. For details, refer to 'Software Installation Guide'.

15.1.2.3 Backup Schedule

Step 1: Click Backup Schedule:

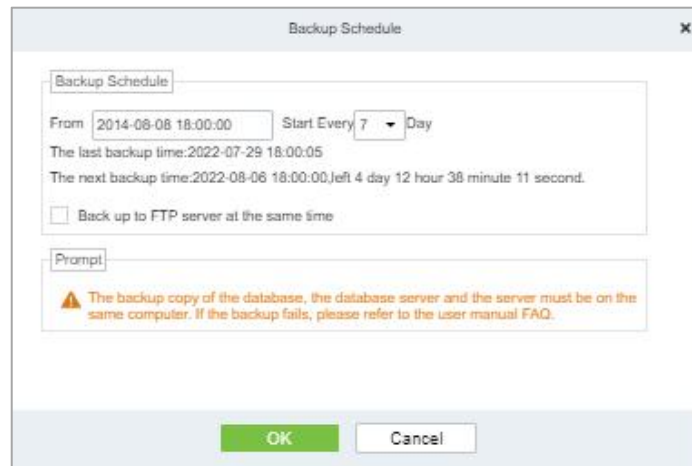

Figure 15-5 Back up Schedule Option

Step 2: Set the start time, set interval between two automatic backups, click **OK**.

15.1.2.4 FTP Server Setting

When send mode is FTP Send Method, FTP parameters should be set. The parameters are FTP Server Address, Server Port, Folder Location, Username, and Password.



Figure 15-6 FTP Server Setting

Parameter	Description
FTP Server Address	Enter the address FTP Server Address E.g.: such as 192.168.1.10.
Port	Enter the port number.
Folder Location	Enter the Folder location.
Username	Enter the Username of the FTP server.
Password	Enter the password for the FTP server.
Test Connection	After configuring the FTP parameters, click Test Connection to test whether the FTP server is communicating normally.

Table 15-1 Description of FTP Server Setting Parameters

After the setup is completed, click the **OK** button, save and return to the Database Management interface.

15.1.3 Area Settings

Area is a spatial concept which enables the user to manage devices in a specific area. After area setting, devices (doors) can be filtered by area upon real-time monitoring.

The system, by default, has an area named **Headquarters** and numbered **1**.

15.1.3.1 Refresh

Click **Refresh** at the upper part of the list to get the most updated version of the Area setting page.

15.1.3.2 New

Step 1: Click **System > System Management > Area Setting > New**.

Step 2: Click **OK** to finish adding.

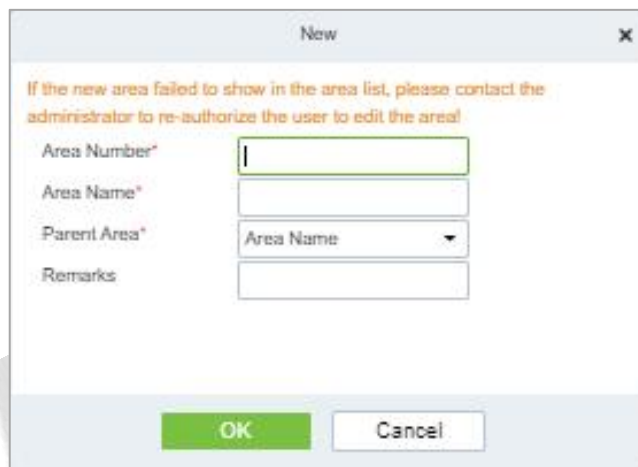

Figure 15-7 Area Setting

Parameter	Description
Area Number	Enter the Area number. It must be unique.
Area Name	Enter the area name. Any characters with a length less than 30.
Parent Area	Determine the area structure of system.

Table 15-2 Description of Area Setting Parameters

15.1.3.3 Export

Export the operation log records, save to local. You can export to an Excel, PDF, TXT or CSV file. Click Export See the following figure.

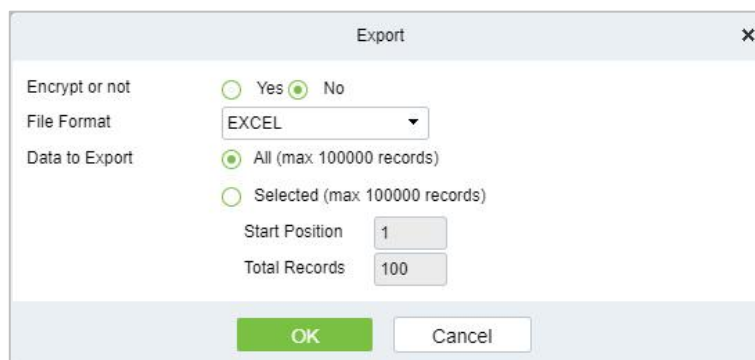

Figure 15-8 Export Option

15.1.3.4 Edit/Delete an Area

Click **Edit** or **Delete** as required under **Operation** to go to the edit or delete page. Then click **OK** to save the setting.

15.1.3.5 Import

If there is a personnel file in your computer, you can Import it into the system.

Step 1: Click Import

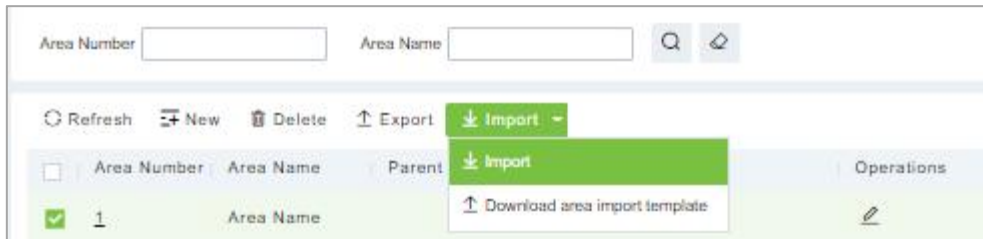

Figure 15-9 Import Interface

Step 2: Select the file format to be imported (default is Excel) and choose the file to be imported.

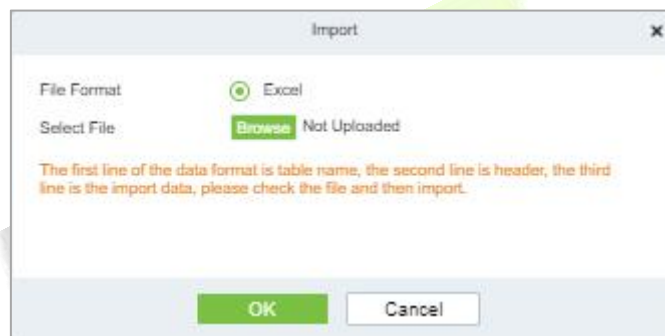

Figure 15-10 Import Option

Step 3: If you want to download the sample template excel file for importing, click the **Download Area Import Template.**

area import template				
Area Number	Area Name	Parent Area Number	Parent Area Name	Remarks

Figure 15-11 Aera Import Template

Step 4: Once the sample excel is downloaded, you can fill your data into it and save it. Then upload the saved file.

15.1.4 E-mail Management

Set the email sending server information. The recipient e mail should be set in Linkage Settings.

Step 1: Click **System > System Management > Email Management**

15.1.4.1 Refresh

Click **Refresh** at the upper part of the list to get the most updated version of the Email management page.

15.1.4.2 Delete

Click **Delete** as required under operation to go to the edit or delete page. Then click **OK** to save the setting.

15.1.4.3 Outgoing Mail Server Settings

Click **System > System Management > Email Management > Outgoing Mail Server Settings**.

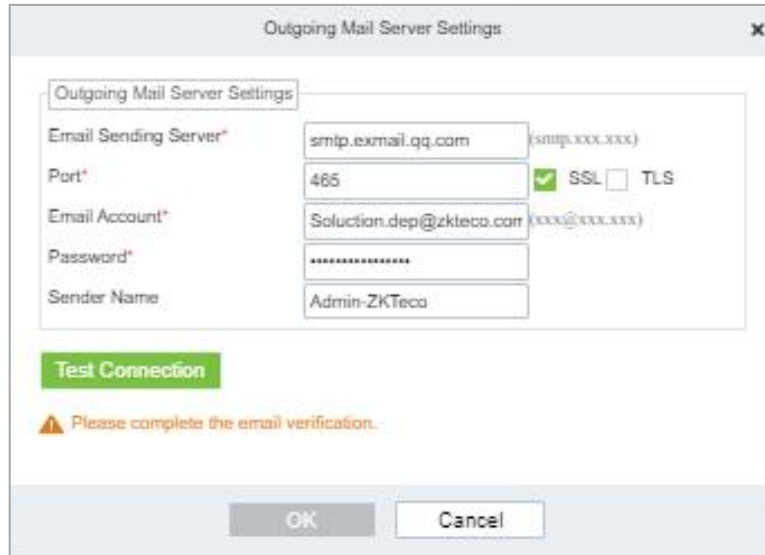

Figure 15-12 Outgoing Mail Server Setting

Note: The domain name of E-mail address and E-mail sending server must be identical. For example, the Email address is test@gmail.com, and the E-mail sending server must be smtp.gmail.com.

15.1.4.4 Export

Export the operation log records, save to local. You can export to an Excel, PDF, TXT or CSV file. Click Export See the following figure.

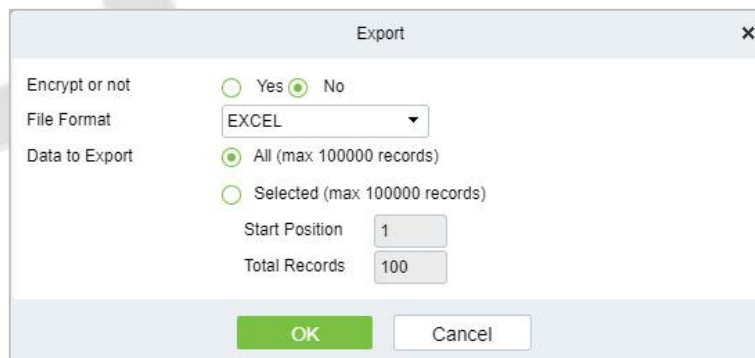

Figure 15-13 Export Option

15.1.5 Dictionary Management

Data dictionary management function, users can find the meaning of error code and self-check software errors.

Module	Dictionary classification	Key name	Value
System	Gender	M	Male
System	Gender	F	Female

Figure 15-14 Dictionary Management Interface

15.1.6 Data Cleaning

To save disk storage space, the expired data generated by the system must be cleaned up regularly

Click **System > System Management > Data Cleaning**. The data cleaning frequency can be set to Day/Week/Month.

15.1.6.1 Record

This option helps you to set the frequency of retain the recent data of the access transaction, attendance transaction, elevator transactions and visitor transactions etc.

Record

Access Transactions *
Retains the recent: 15, Month
Execution Time: 01:00:00
(Carefully clean up)

Attendance Transactions *
Retains the recent: 15, Month
Execution Time: 03:00:00
(Carefully clean up)

Elevator Transactions *
Retains the recent: 15, Month
Execution Time: 01:00:00
(Carefully clean up)

Visitor Transaction *
Retains the recent: 15, Month
Execution Time: 01:00:00
(Carefully clean up)

Parking Transactions *
Retains the recent: 15, Month
Execution Time: 01:00:00
(Carefully clean up)

Patrol Transactions *

Figure 15-15 Record Interface

15.1.6.2 Disk Space Cleanup

In this option you can set the frequency of the retains the recent and also clean up the selecyted days data.

Disk space cleanup

IVS Alarm Photos*
Retains the recent
7 Day
Execution Time
01:00:00
Immediately Clean Up

Figure 15-16 Disk Space Cleanup Interface

15.1.6.3 System

This option helps you to clean up the system operation log, device commands and database backup file.

System

System Operation Log *
Retains the recent
15 months of data
Execution Time
03:00:00
(Carefully clean up)

Device Commands *
Retains the recent
6 months of data
Execution Time
02:00:00
Immediately Clean Up

Database Backup File *
Retains the recent
8 months of data
Execution Time
04:00:00
Immediately Clean Up

Figure 15-17 System Interface

15.1.7 Audio File

Click **System > Basic Management > Audio File** to open the following interface:



Figure 15-18 Audio File Interface

15.1.7.1 New

Operation Steps

Step 1: Click **System > System Management > Audio File > New**, the following window appears:

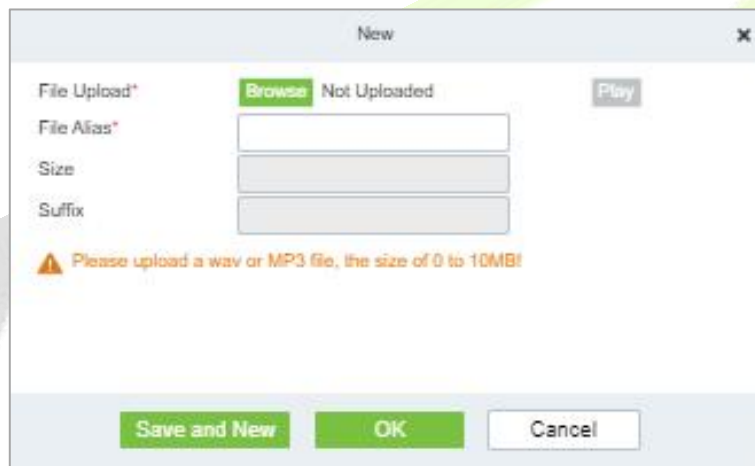

Figure 15-19 New Option

Step 2: **Browse** to upload an audio file locally. The file format must be in WAV or mp3 format and must not exceed 10MB in size.

Parameter	Description
File Alias (Name)	Enter the file name. Any character, up to 30 characters.
Size	After uploading the file, the file size is automatically generated.
Suffix	After uploading the file, the suffix of the file is automatically generated.

Table 15-3 Description New option parameter

15.1.7.2 Refresh

Click **Refresh** at the upper part of the list to get the most updated version of the Audio file page.

15.1.7.3 Edit

Click the file name or **Edit** to edit the audio file details which support replacing the audio files and editing the file name. The "size" and "suffix" automatically change depending on the size and type of audio file being uploaded. After editing, click **OK** and **Exit**.

15.1.7.4 Delete

Select the specified audio file to delete and click Delete. Then click **OK** to save the setting.

15.1.8 Certificate Type

The system initializes 9 certificate types. User can add the required certificate type for personnel and visitor registration.

Step 1: Click **System > Basic Management > Certificate Type**.

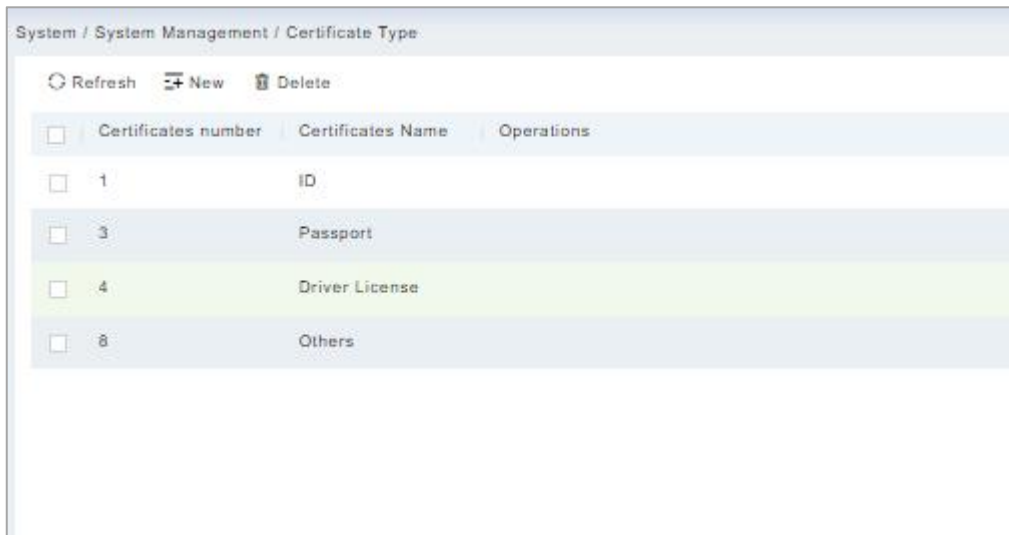

Figure 15-20 Certificate Type Interface

15.1.8.1 Refresh

Click **Refresh** at the upper part of the list to get the most updated version of the certificate type page.

15.1.8.2 New

Operation Step:

To add the certificates, click **System > Basic Management > Certificate Type > New**:

Certificate Name: Enter the certificate name.

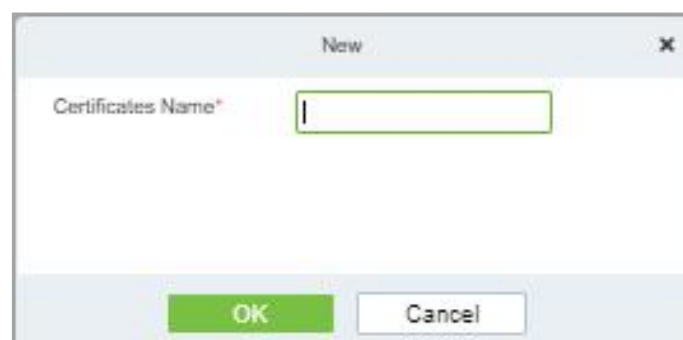

Figure 15-21 New Option

15.1.8.3 Delete

Select the specified certificate to delete and click **Delete**. Then click **OK** to save the setting.

15.1.9 Print Template

You can manage the template for different cards: Personnel card template, Visitor receipt template/Card template are all configured here. The system initializes 5 types of personnel and visitor print templates.

Step 1: Click **System > Basic Management > Print template.**

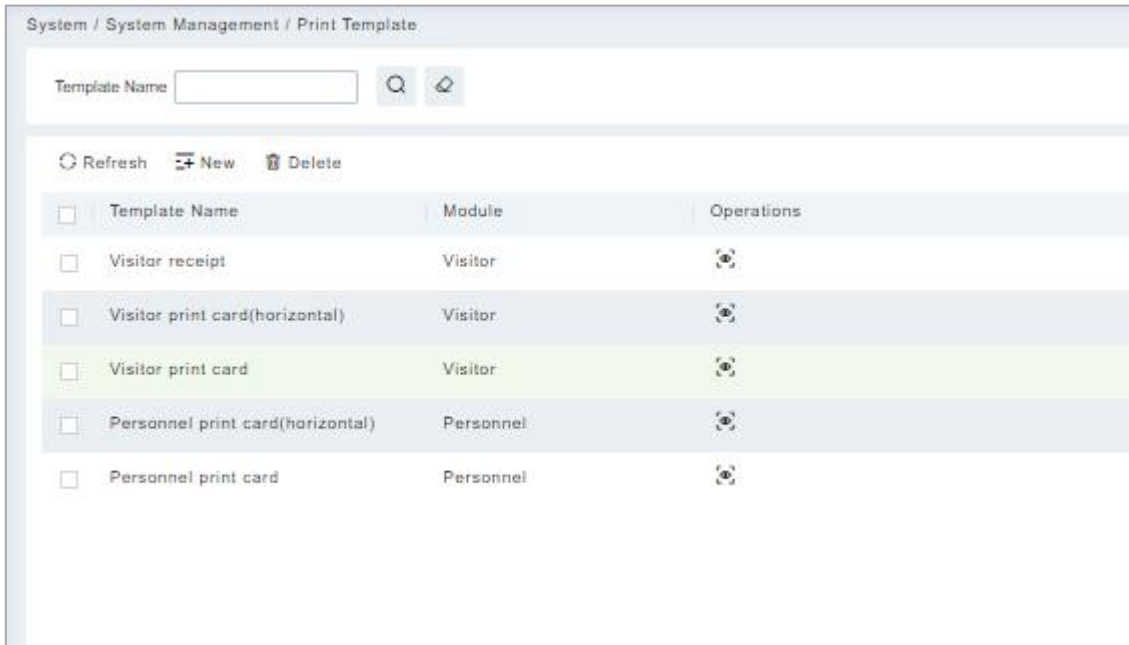

Figure 15-22 Print Template

15.1.9.1 Refresh

Click **Refresh** at the upper part of the list to get the most updated version of the Print Template page

15.1.9.2 Add

Step 1: To add the certificates, click **System > System Management > Print Template > New:**

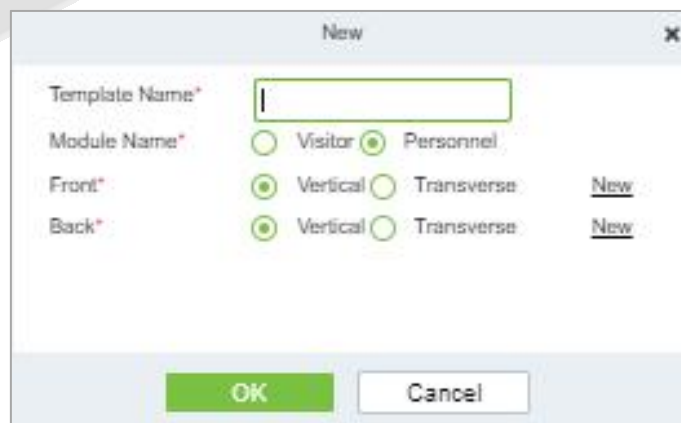

Figure 15-23 New Option

15.1.9.3 Delete

Select the specified template to delete and click **Delete.**

15.1.10 System Monitoring

The system monitoring function displays the server processor usage, host memory usage, processor information, memory information, java virtual machine memory usage and other information.

Step 1: Click System > System Management > System Monitoring.

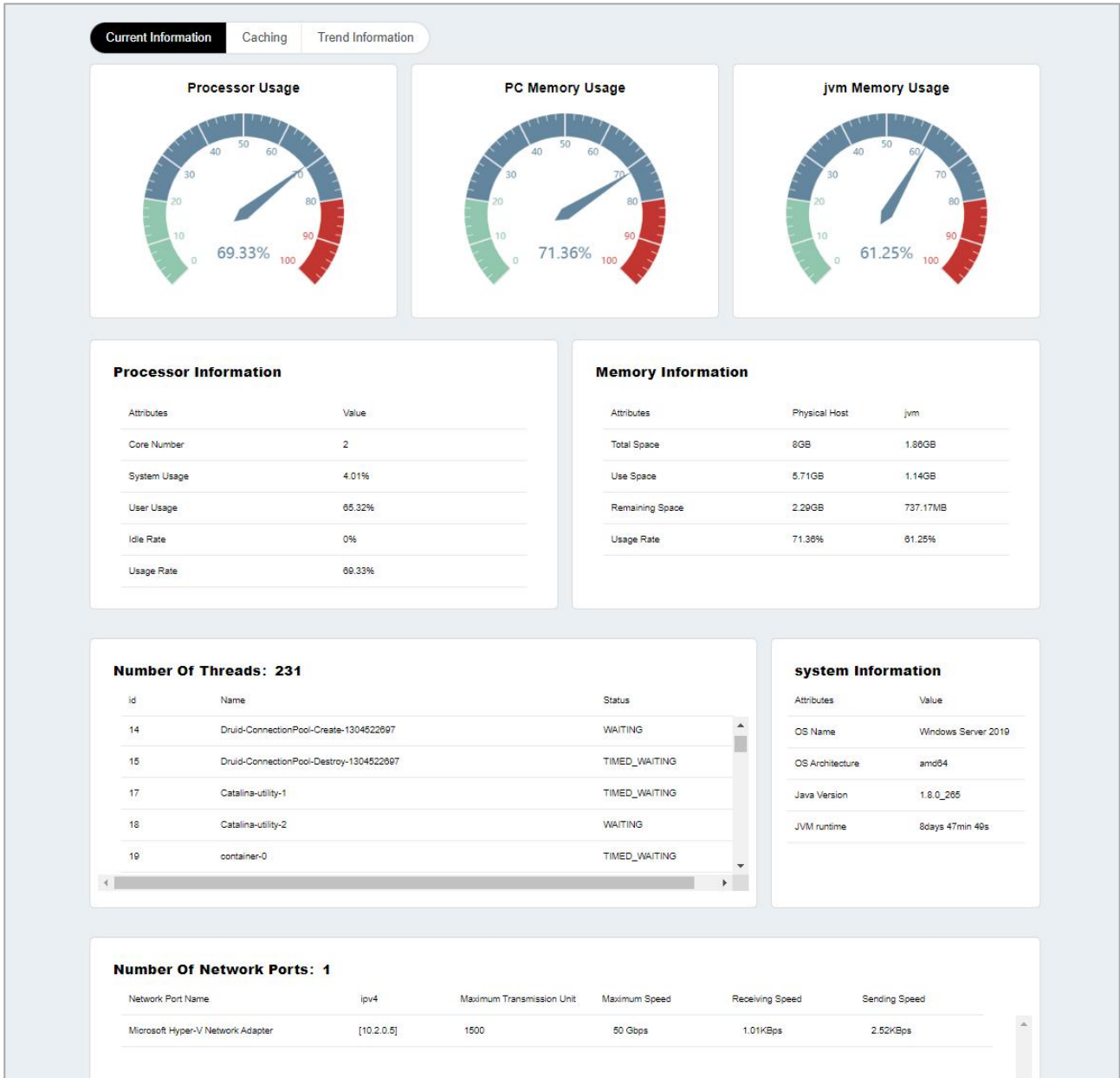

Figure 15-24 System Monitoring Interface

15.1.10.1 Caching

This option helps you to know about memory information, Redis information, client information and also current data base.

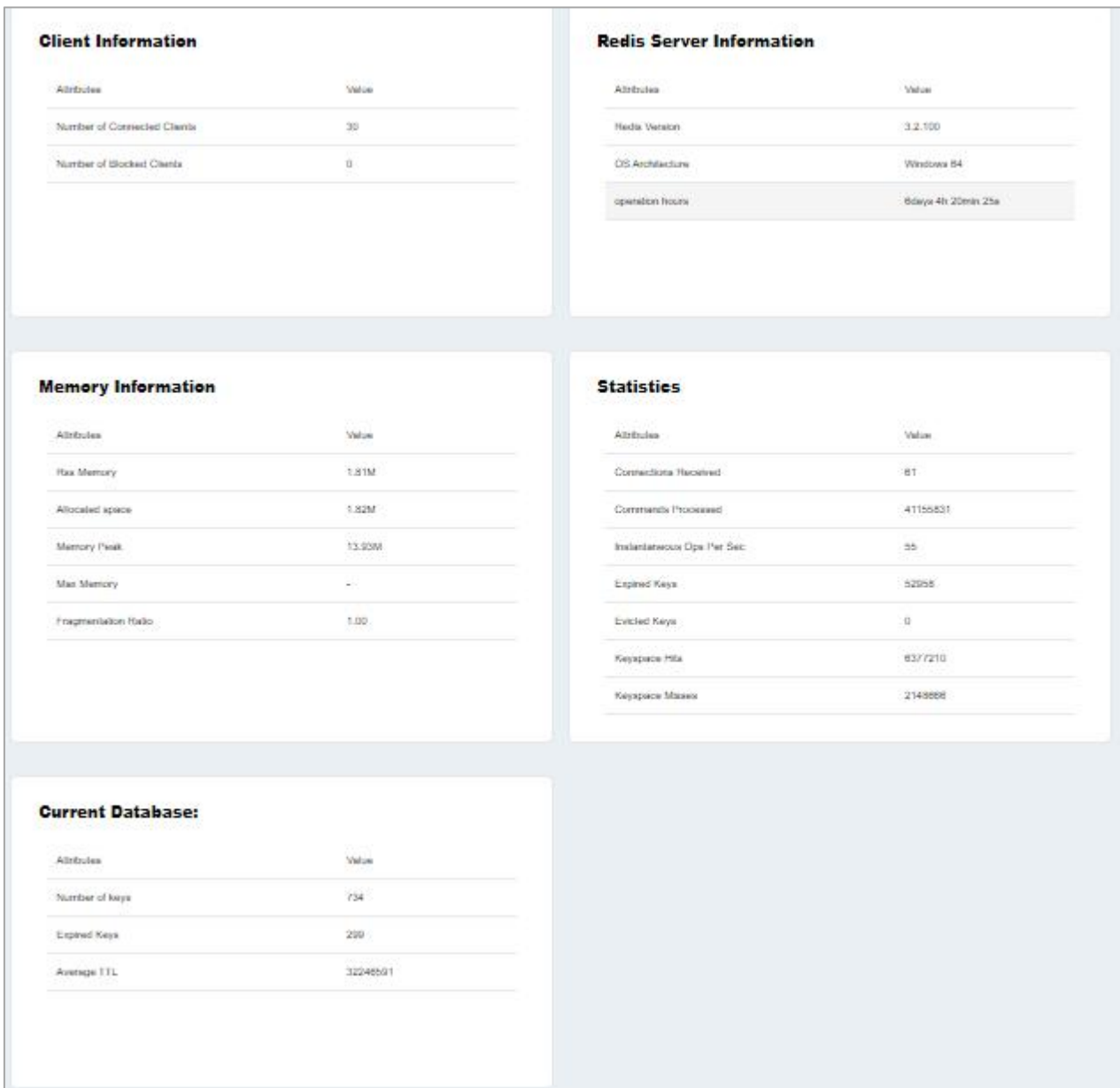

Figure 15-25 Caching Interface

15.1.10.2 Trend Information

This option shows the graphical representation of processor usage , Pc memory usage and jvm memory usage.

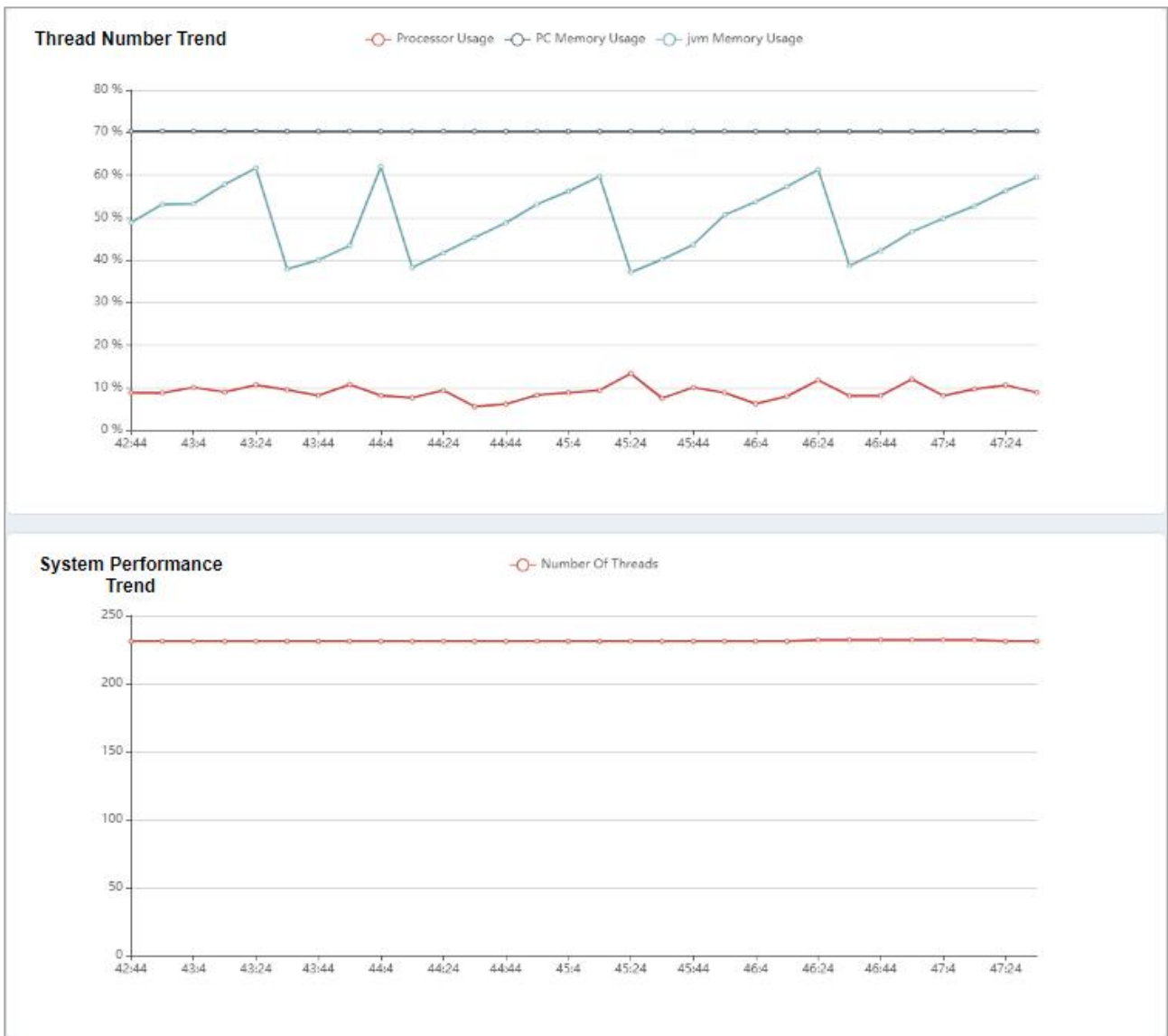

Figure 15-26 Trend Information Interface

15.1.11 Parameters

15.1.11.1 QR Code Setting

Step 1: Click **System > System Management > Parameter > QR Code Setting.**



Figure 15-27 QR Code Setting interface

Step 2: Enable QR code Click **System > System Management > Parameter > YES** or **NO** for Enable the QR code

Step 3: Enable QR code If YES click **YES > Static**. It will be fixed the QR information same manner for the rest of time.

Step 4: Enable QR code If YES click **YES > Dynamic > Valid Time**. It will generate new QR code every 30 seconds.

15.1.11.2 Date Time Format Setting

Here you can set the date and time format.



Figure 15-28 Date and Time Format Setting Interface

15.1.11.3 Video Watermark

This option helps you to add watermark and tile to your videos.



Figure 15-29 Video WaterMark Setting

15.2 Authority Management

15.2.1 User

15.2.1.1 New

This section describes how to configure Step to add an administrator user in ZKBio CVSecurity.

Operation Step

Step 1: In the **System** module, choose **Authority Management > User**.

Step 2: Click **Add** to pop up the new user interface.

Step 3: On the Add role page, set role rights as required, as shown in the below Figure and the below Table describes parameters to be set.

The screenshot shows a 'New' user interface window with the following fields and options:

- Username***: Text input field. Note: Username should be composed between 1-30 characters and in letters, numbers, or symbols (@/./-/+/_).
- Password***: Password input field. Note: Password is a composition of 4 to 18 characters, default is 111111.
- Confirm Password***: Password input field.
- State**: Dropdown menu with 'Enable' selected.
- Multiple Login**: Checkbox (unchecked).
- Maximum Number**: Input field. Note: Limit multiple login for the same account.
- Superuser State**: Checkbox (unchecked).
- Role**: Dropdown menu.
- Auth Department**: Dropdown menu. Note: If you don't select department you will not have full departmental permission.
- Authorize Area**: Dropdown menu. Note: If you don't select zone you will not have full zone permission.
- Email**: Text input field.
- First Name**: Text input field.

Buttons at the bottom: Save and New (green), OK (green), Cancel (white).

Figure 15-30 Adding User Interface

Parameter	How to set up
User Name/Password	You can customize the user's name and password used for login.
State	Set whether the user can log in and operate the system.
Connection Limit/Maximum Logins	If this parameter is not selected, the number of simultaneous logins is not limited.
Superuser Status	This parameter specifies whether the user has all rights by default. If you click this parameter, the user is a super user, and no role is required.
Role	Set a role for the user. The user has all Operation permissions configured for the role.
Authorize Department	Authorization Sets the department permissions of the user.

Parameter	How to set up
Authorized Permission	Authorization Sets the area rights that the user has.
Email	Customizes this user’s mailbox, which can be used to retrieve the password.
The Name	Custom sets the name of this user.
The Fingerprint Registration	Register this user’s fingerprint.

Table 15-4 Parameters for Adding a User

Step 4: Click **OK** to finish configuring the new user.

15.2.1.2 Edit/Delete

Click **Edit** or **Delete** as required.

15.2.2 Role

When using the system, the super user needs to assign different levels to new users. To avoid setting users one by one, you can set roles with specific levels in role management and assign appropriate roles to users when adding users. A super user has all the levels, can assign rights to new users and set corresponding roles (levels) according to requirements.

15.2.2.1 Refresh

Click **Refresh** at the upper part of the list to get the most updated version of the user page.

15.2.2.2 New

Operation Steps:

Step 1: Click **System > Authority Management > Role > New**.

Step 2: Set the name and assign permissions for the role.

Step 3: Click **OK** to save.

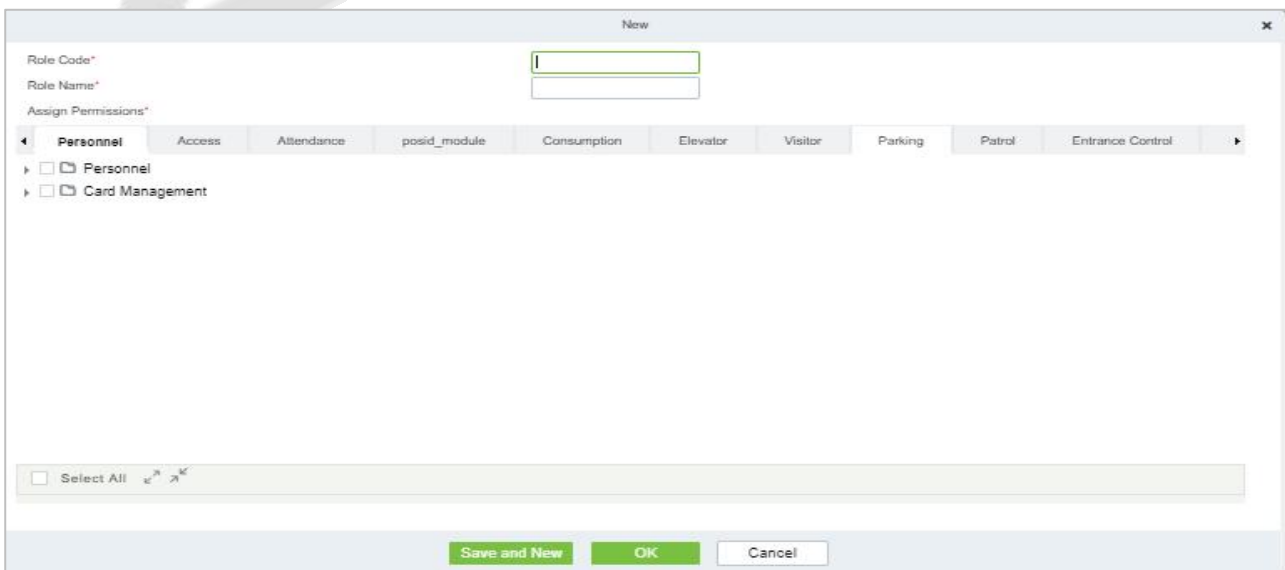

Figure 15-31 Add Role Option

15.2.2.3 Edit/Delete

Click **Edit** or **Delete** as required.

15.2.3 API Authorization

15.2.3.1 Refresh

Click **Refresh** at the upper part of the list to get the most updated version of the API authorization page.

15.2.3.2 New

Operation Steps:

Step 1: Log in to the system (as the super user, for exaportal.min) to enter the software. Click **System > Authority Management > API Authorization >New**, which must be unique, and a client secret, which will be used when the API is invoked.

Step 2: Only when the client ID and secret are added can the next API operation page be displayed normally. Otherwise, the access is abnormal):

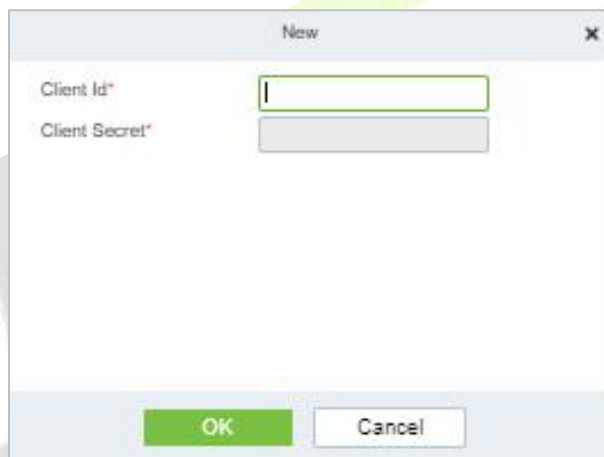

Figure 15-32 API Authorization Option

15.2.3.3 Browse the API

After the client ID and secret are added, click Browse API on the API Authorization page to skip to the API operation page (The page of the ZKBioSecurity system must be open for normal access of the API operation page). This page provides multiple APIs.

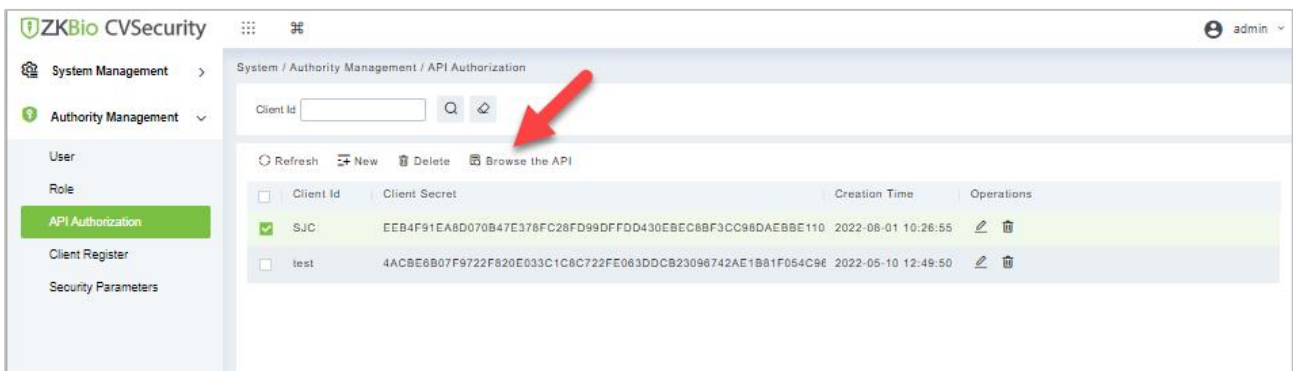

Figure 15-33 Browse the API



Figure 15-34 ZKBIO CV Security API Interface

When APIs are invoked, URLs of all request APIs must contain the access token parameter, whose value is determined by the client key configured on the background (if there are multiple keys, only one is selected), for example:



Figure 15-35 Request URL

The access token parameter must be added when the API is invoked (one request URL can be invoked):
http://localhost:8091/system/swagger/index.html?clientId=1653914953805#!/Person/getByPinUsingGET.

15.2.3.4 Edit

Click the **Edit** icon to edit the API AThorization details Enter the required Details.After editing, click **OK** and exit

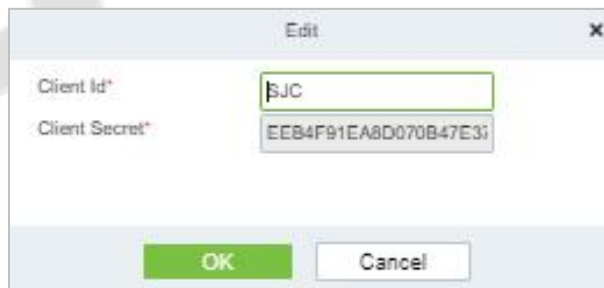

Figure 15-36 Edit Option

15.2.3.5 Delete

Select the specified Client id to delete and click **Delete**.Then Click **OK** to confirm the operation.

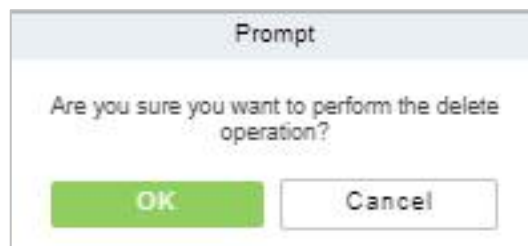

Figure 15-37 Delete Option

15.2.4 Client Register

You can add client types for the system and generate registration codes for client registrations of each module function. The number of allowed clients is controlled by the number of allowed points.

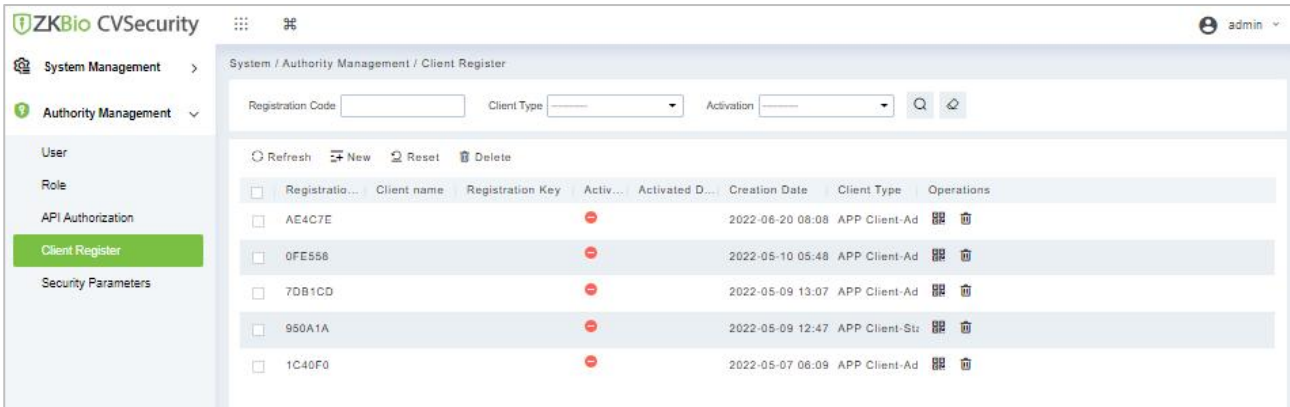

Figure 15-38 Client Register Interface

15.2.4.1 New

Step 1: Click **System Management > Authority Management > Client Authorization > New** to go to the **New** page.

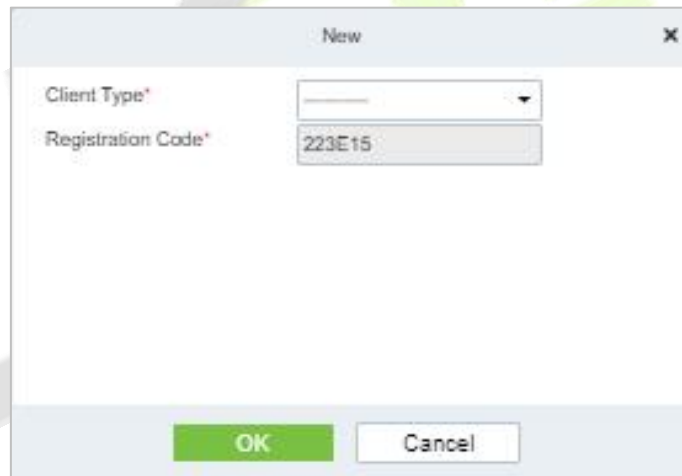

Figure 15-39 Add Client Register

Parameter	Description
Client Type	The value can be APP Client, OCR-Personnel, OCR-Visitor, ID Reader-Personnel, ID Reader-Visitor or Signature- Visitor, Card Printing- Personnel, Card Printing-Visitor.
Registration Code	The registration code for APP Client is used under Network Settings on the APP login page and that for Print Card-Personnel is used under Parameter Settings > Client Registration . Only new registration codes added on the server are authorized and one registration code can be used by only one client.

Table 15-5 Description Add Client Register parameter

15.2.4.2 Reset

To reset a client, select the client and click **Reset**.

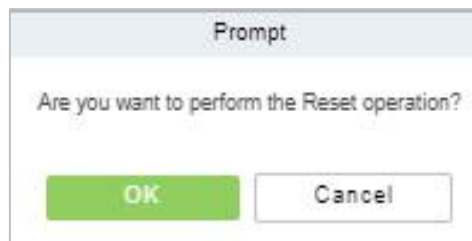

Figure 15-40 Reset Option

15.2.4.3 Delete

To delete a client, select the client and click **Delete**.

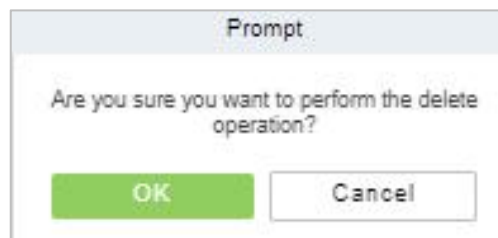

Figure 15-41 Delete Option

Click **OK** to delete the client.

15.2.5 Security Parameters

Click **System Management > Authority Management > Set Security Parameters**.

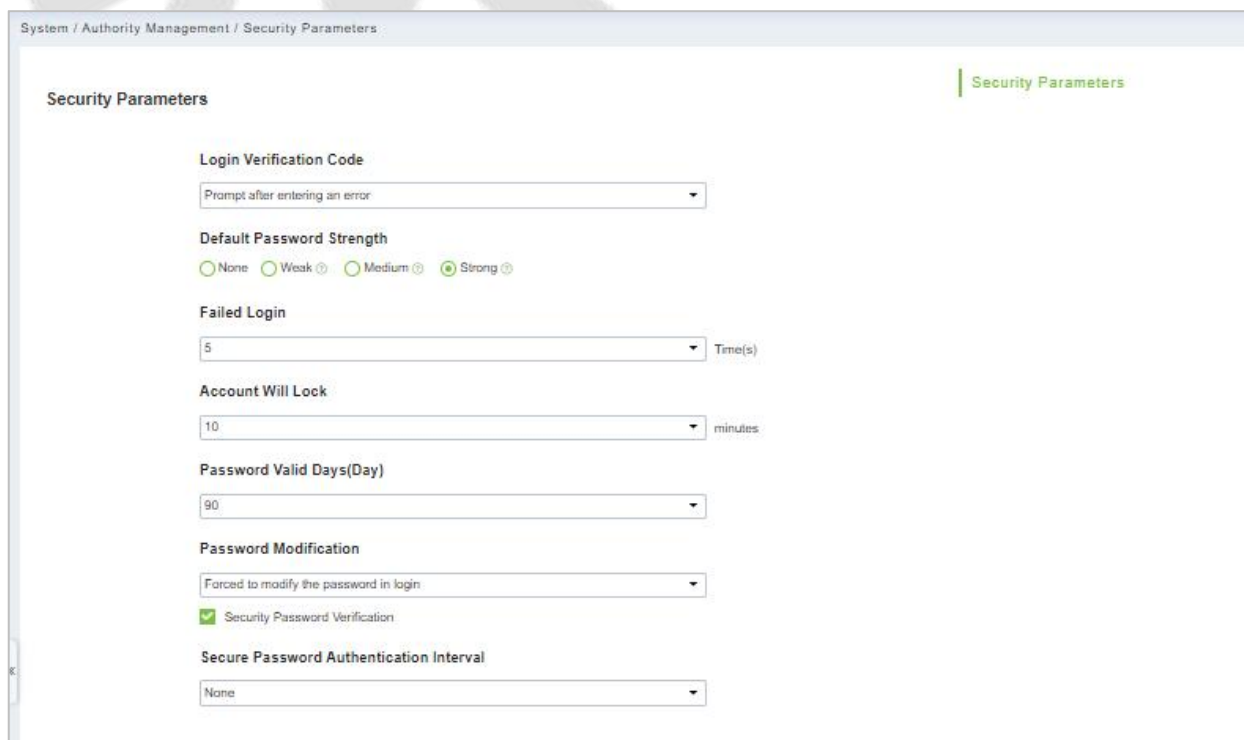

Figure 15-42 Security Parameter Interface

- **Login Verification Code Setting**

It includes None, always prompt verification code, Prompt after entering an error.

Do not open verification code: The system allows no verification code

Open verification code: Users must fill in the verification code when logging in to the software.

Open after input error: The system will pop-up a verification box after filling in the wrong Username and password.

- **Password Strength Setting**

The path is **System -> Authority Management-> Set Security Parameter.**

A screenshot of a configuration window titled "Default Password Strength". It contains four radio button options: "None", "Weak", "Medium", and "Strong". The "Strong" option is selected, indicated by a green dot.

Figure 15-43 Password Strength Option

- **Lock Account**

The account will be locked if user fails to login the system as per the software setting. For example, if the system allows user fill in wrong username and password for 2 times. The system will be locked for 10 minutes after exceeding 2 times of operation.

A screenshot of a configuration window titled "Failed Login". It has two sections. The first section, "Failed Login", has a dropdown menu set to "5" and the label "Time(s)". The second section, "Account Will Lock", has a dropdown menu set to "10" and the label "minutes".

Figure 15-44 Lock Account

- **Password Valid Day (s)**

Users can set the validity as 30days, 60days or permanent. If password gets expired, user cannot login to the system.

A screenshot of a configuration window titled "Password Valid Days(Day)". It features a single dropdown menu set to "90".

Figure 15-45 Password Valid Days

- **Password Modification**

There are 2 options that user can set. Not mandatory and forced to modify the next time you login.

Not mandatory: The system does not need to modify the initial password.

Forced to modify the next time you login: It is compulsory to modify the initial password after the second login.

A screenshot of a configuration window titled "Password Modification". It has a dropdown menu set to "Forced to modify the password in login" and a checked checkbox labeled "Security Password Verification".

Figure 15-46 Password Modification Option

● **Secure Password Authentication Interval**

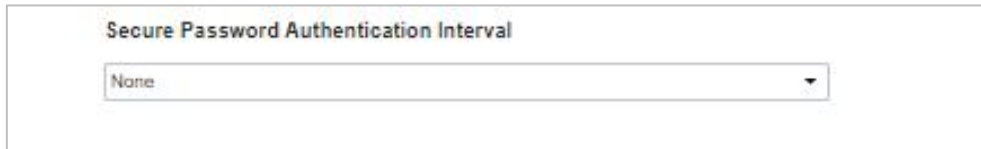

Figure 15-47 Secure Password Authentication Interval

15.3 Communication Management

15.3.1 Device Commands

Step 1: Click **System > Communication Management > Device Commands**, the commands lists will be displayed.

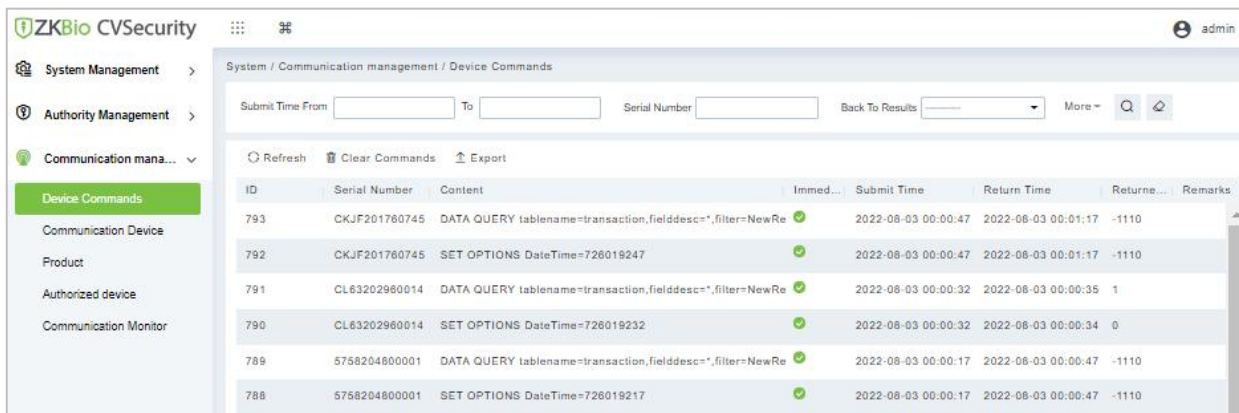

Figure 15-48 Device Comand interface

If the returned value is more than or equal to 0, the command is successfully issued. If the returned value is less than 0, the command is failed to be issued.

15.3.1.1 Export

Export the command lists to the local host. You can export it to an Excel file. See the following figure.

ID	Serial Number	Content	Device Commands		Return Time	Returned Value
			Immediately Cmd	Submit Time		
1504	20100501999	DATA UPDATE userauthorize Pin=2AuthorizeTi mezoneId=1Auth orizeDoorId=1 Pin=1AuthorizeTi mezoneId=1Auth orizeDoorId=1 ...	false	2017-12-18 10:51:15	2017-12-18 10:51:21	0
1502	20100501999	DATA UPDATE mulcarduser Pin=2CardNo=5d ec02LossCardFla g=0CardType=0 Pin=1CardNo=44 12c5LossCardFla g=0CardType=0 ...	false	2017-12-18 10:51:14	2017-12-18 10:51:21	0

Figure 15-49 Export File

15.3.1.2 Refresh

Click **Refresh** at the upper part of the list to load new temporary Device Commands.

15.3.1.3 Clear Commands

Click **Clear Commands** to Clear the command lists.

15.3.2 Communication Device

Step 1: Click **System > Communication Management > Communication**, you can view all equipment information and communication in the system. Detailed information such as accessed module, serial number, firmware version, IP address, communication status, and command execution can be viewed.

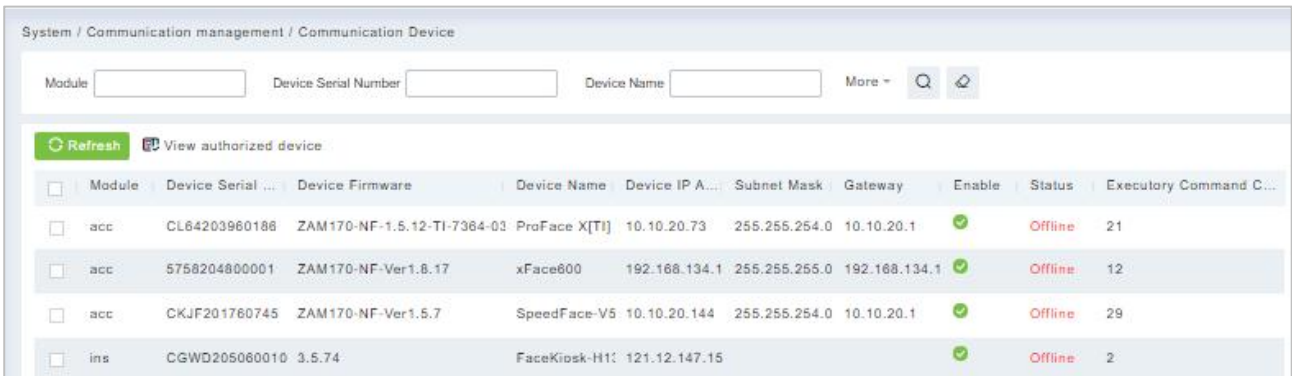

Figure 15-50 Communication Device Interface

15.3.2.1 View Authorized Device

View the authorized device information.

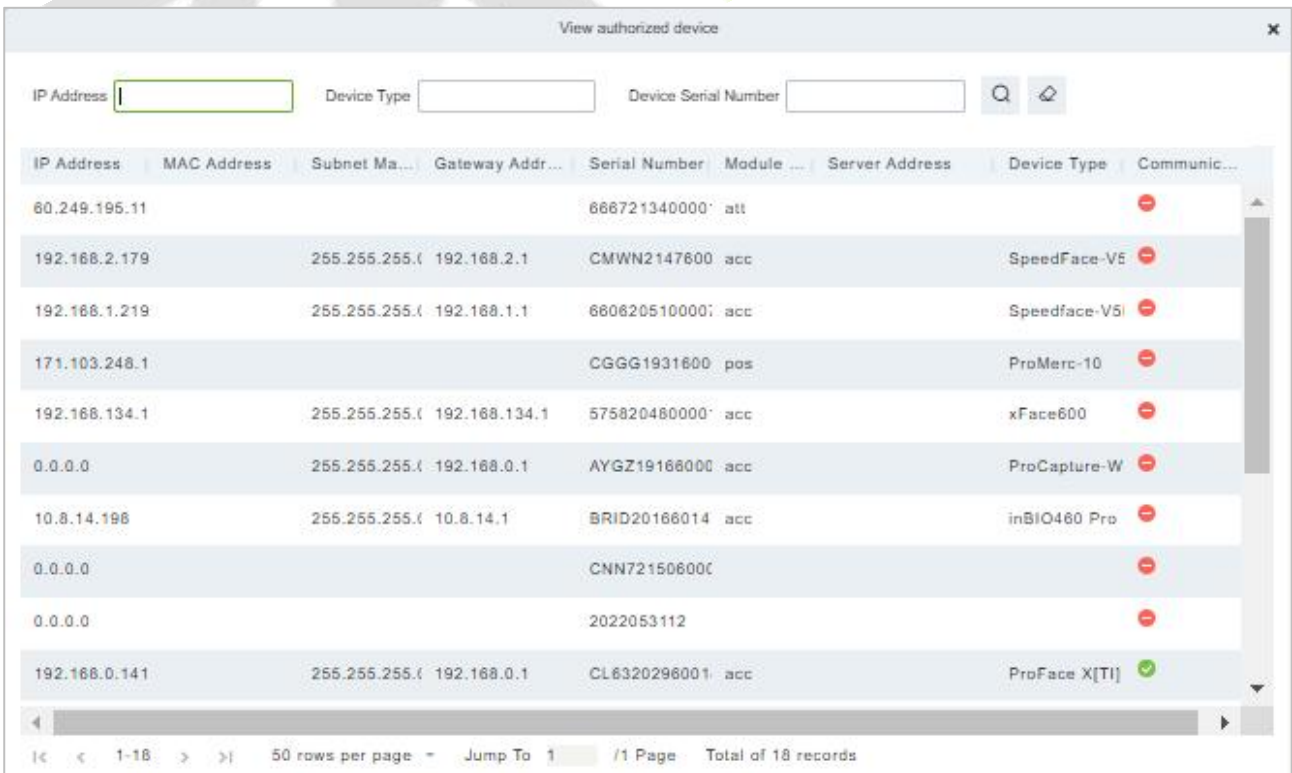

Figure 15-51 View Authorized Device Interface

15.3.2.2 Refresh

Click **Refresh** at the upper part of the list to load the new temporary Communication Device.

15.3.3 Product

Step 1: Click **System > Communication Management > Product**, and the product lists will be displayed.

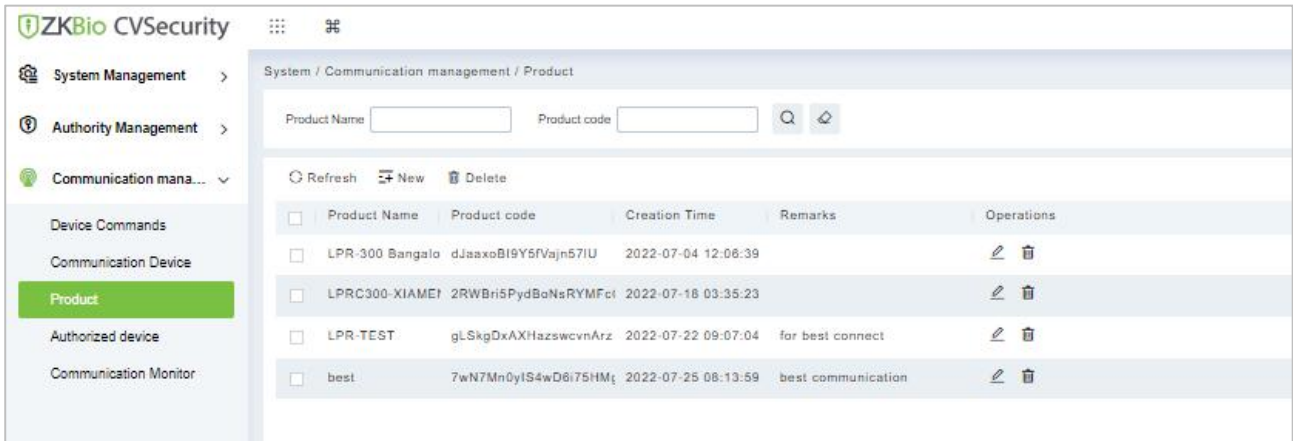

Figure 15-52 Product Interface

15.3.3.1 New

Click **System > Communication Management > Product > New**, to add the new product name.

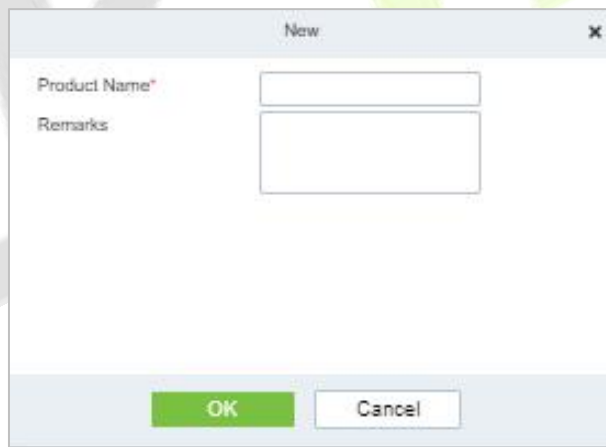

Figure 15-53 Add Product Option

15.3.3.2 Delete

Click **Delete** to delete the Product Operation.

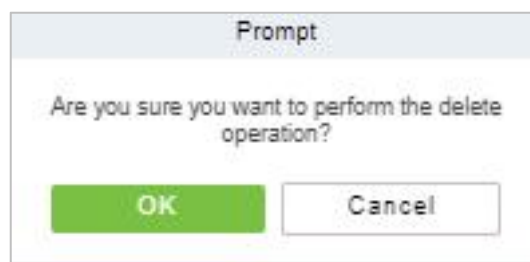
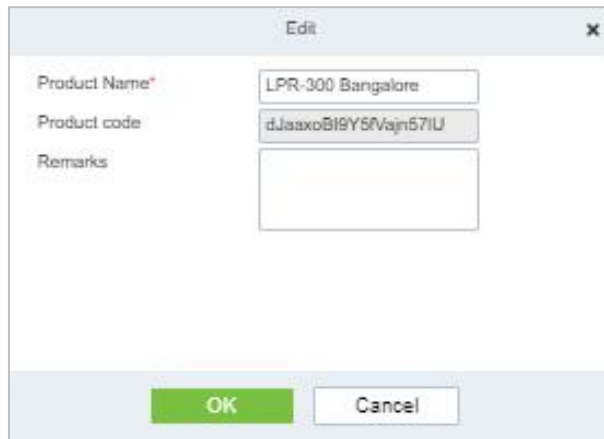

Figure 15-54 Delete Product Option

15.3.3.3 Edit

Click **Edit** to delete the Product information.



The 'Edit' dialog box contains the following fields:

- Product Name*: LPR-300 Bangalore
- Product code: dJaaXoB19Y6Vajjn57IU
- Remarks: (empty text area)

Buttons: OK, Cancel

Figure 15-55 Edit Product Information

15.3.4 Authorized Device

Click **System > Communication Management > Authorized Device**, and the product lists will be displayed.

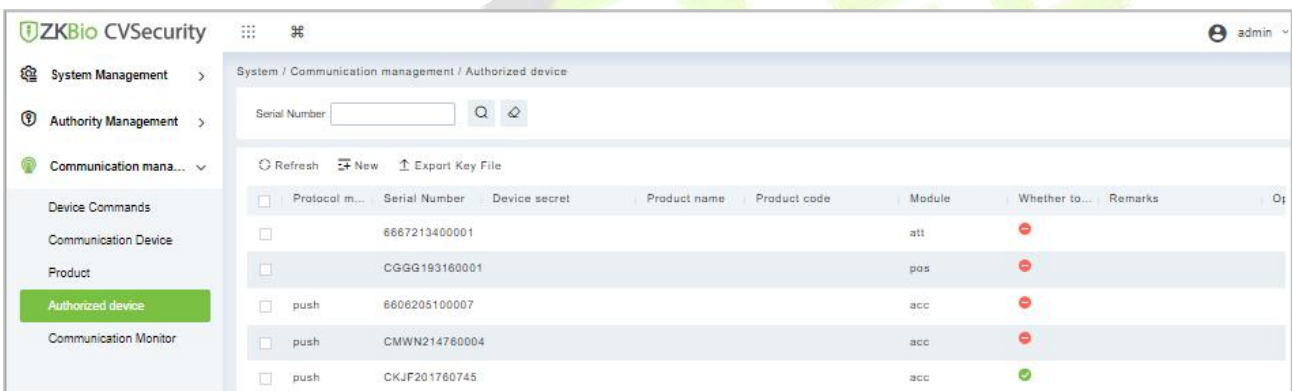

The interface shows a table of authorized devices with the following columns: Protocol mode, Serial Number, Device secret, Product name, Product code, Module, Whether to..., Remarks, and Op.

Protocol mode	Serial Number	Device secret	Product name	Product code	Module	Whether to...	Remarks	Op
<input type="checkbox"/>	6667213400001				att	⊖		
<input type="checkbox"/>	CGGG193160001				pos	⊖		
<input type="checkbox"/>	push	6606205100007			acc	⊖		
<input type="checkbox"/>	push	CMWN214760004			acc	⊖		
<input type="checkbox"/>	push	CKJF201760745			acc	⊕		

Figure 15-56 Authorized Device Interface

15.3.4.1 New

Click **System > Communication > Authorized Device > New**, to add the authorized product device.

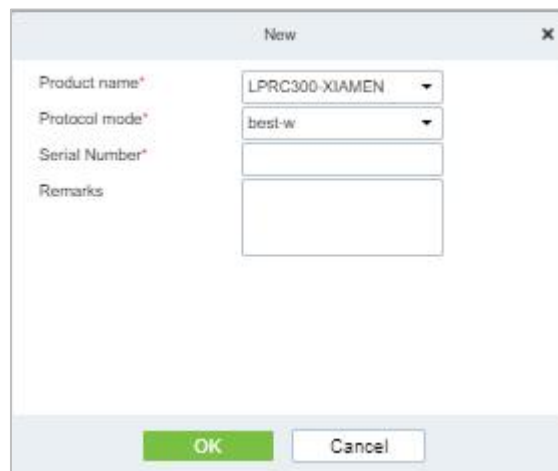

The 'New' dialog box contains the following fields:

- Product name*: LPRC300-XIAMEN
- Protocol mode*: best-w
- Serial Number*: (empty text area)
- Remarks: (empty text area)

Buttons: OK, Cancel

Figure 15-57 Add Authorized Device

15.3.4.2 Export Key File

Click **System > Communication > Authorized Device**, Select the protocols to export and click the **Export Key File**, to export the key file of the authorized product device.

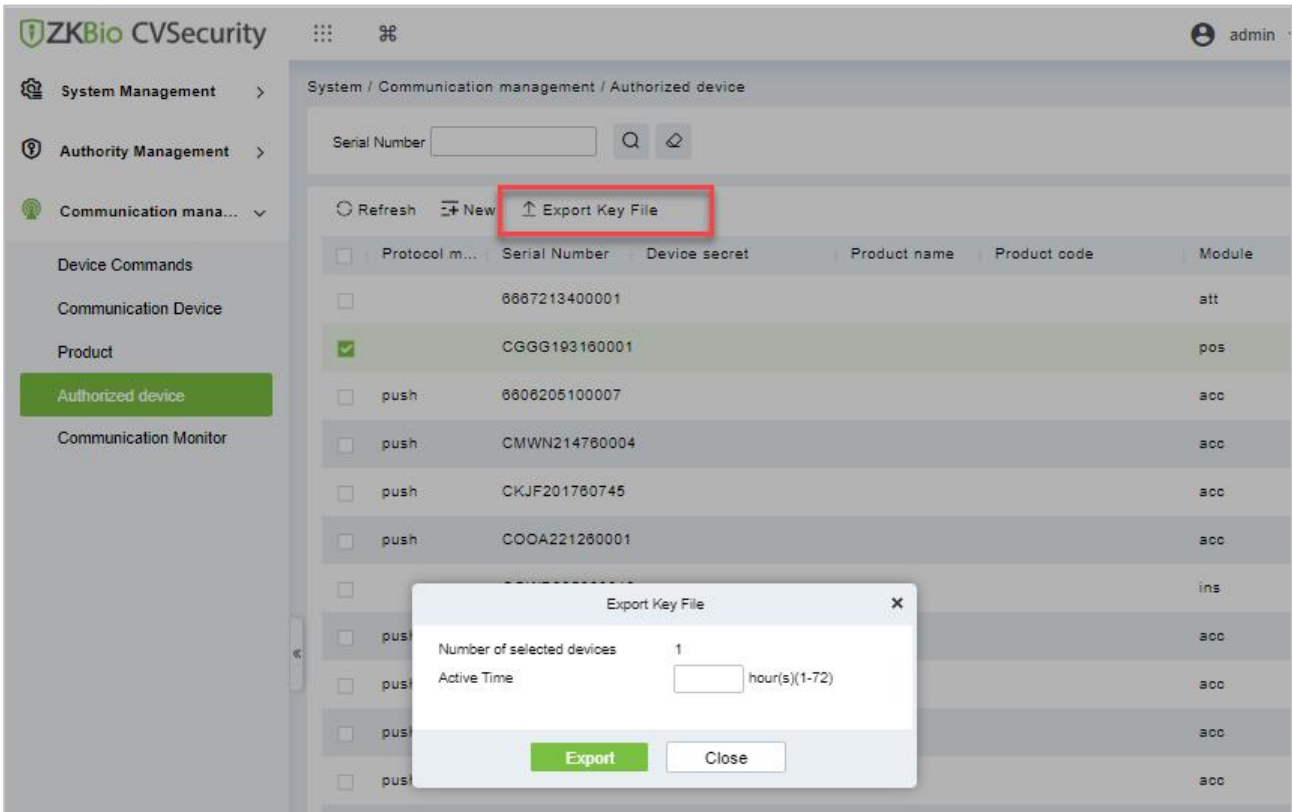

Figure 15-58 Export Key Option

15.3.5 Communication Monitor

Click **System > Communication > Communication Monitor**, and the communication mode will be displayed.

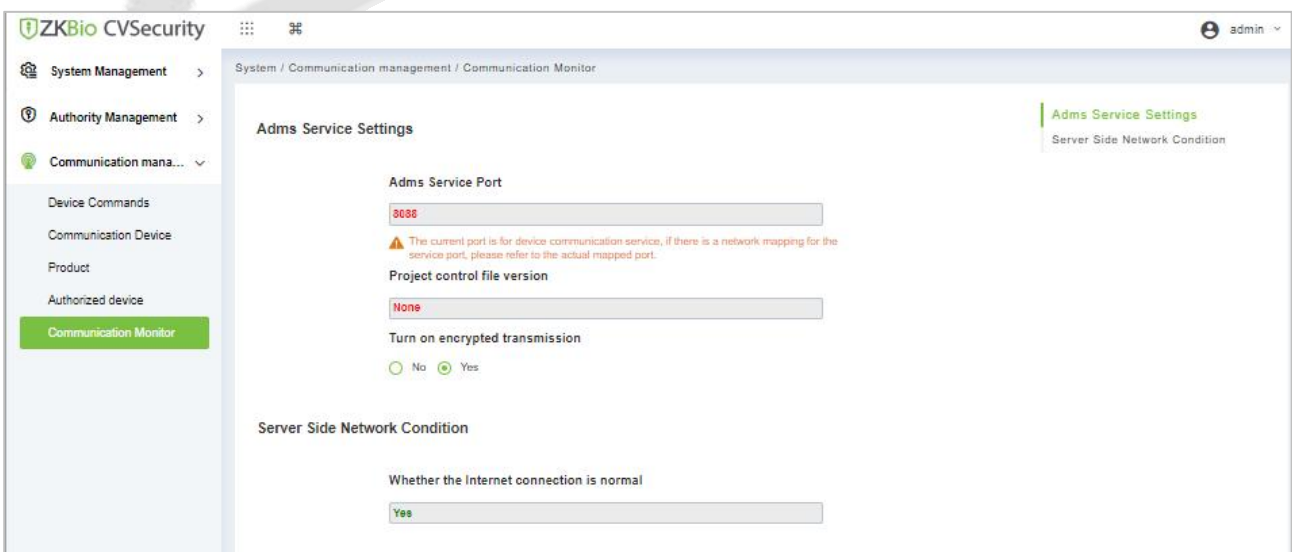

Figure 15-59 Communication Monitor

15.4 Third Party Integration

15.4.1 LED Device

The system integrated outsourcing LED equipment (control card: lumens 3200/4200), provides a window to display data; it can provide customers personnel in the access area quantity statistics, real-time information about personnel going in and out and personnel information in the area, etc.

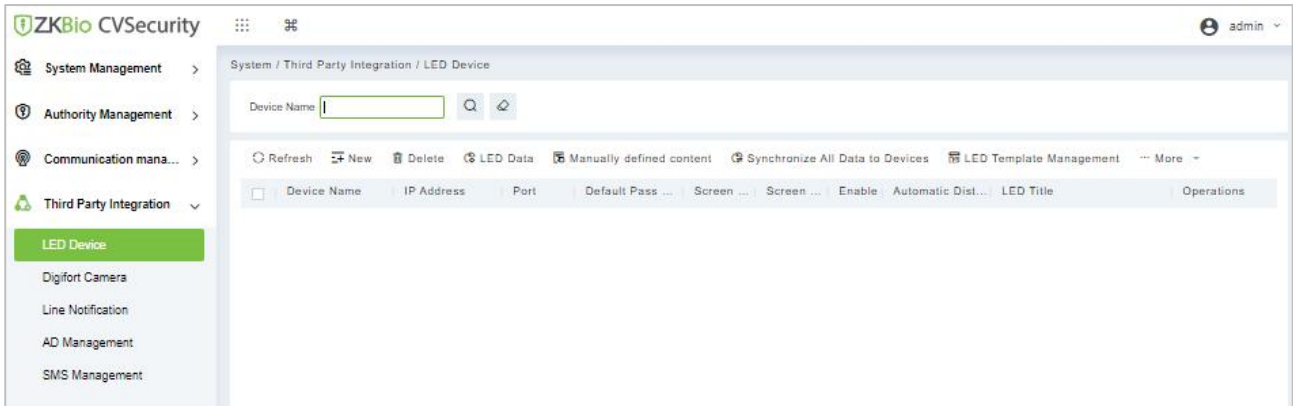

Figure 15-60 LED Device

15.4.1.1 New

Operation Step:

Step 1: Click **System**> **Extended Management**> **LED Device**> **New**. The page is displayed as follows:

Figure 15-61 Add LED Device

Parameter	Description
Device Name	Enter the name of the LED device.
IP Address	Enter the IP address of the LED device.

Port	Enter the port number. The default communication port is 5200.
Default Pass Code	Displays the pass code. The default value is 255.255.255.255.
Screen Width	Width of the dot matrix (resolution).
Screen Height	Height of the dot matrix (resolution).
LED Title	Select whether to display the title. If the parameter is left blank, the title is not displayed.
Block Number	Number of blocks that the LED is divided into (Note that the blocks do not contain the title and system time blocks).
Show Time	It will display time on the LED screen. Once you select it, you will find two options to choose from: Single Line and Multiline Display. Choose according to your choice.
Automatic Distribute Data	By default, this parameter is selected. You send data to the LED in the access control module only when you select this parameter. Otherwise, the content to be sent needs to be manually defined.
Delete Data in the Device When New	Delete the original data in the device when adding an LED device.

Table 15-6 Description Add LED Device Parameter

After you click **Block Layout**, the following box is displayed:

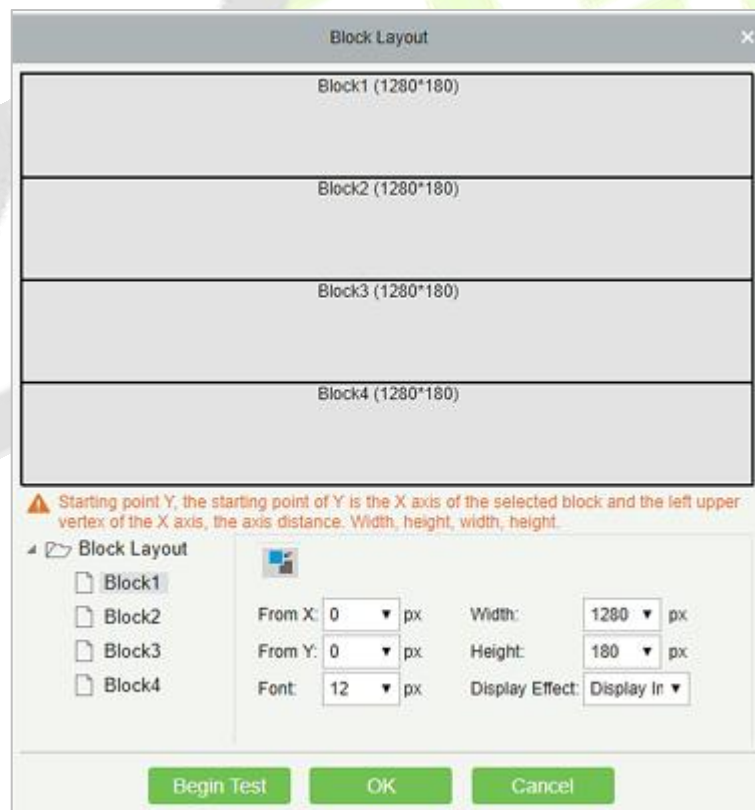

Figure 15-62 Block Layout

Notes:

Parameters must be set for each block.

The height of each block must be equal to or larger than 12. Otherwise, the letters cannot be completely displayed.

The total height of all blocks cannot be larger than the screen height.

15.4.1.2 Delete

Click a device name or **Delete** under Operation in the device list and click **OK** to delete the device or click **Cancel** to cancel the operation. Select one or more devices and click Delete above the list and click **OK** to delete the selected device(s) or click **Cancel** to cancel the operation.

15.4.1.3 LED Data

LED data option let you view the details about outsourcing LED equipment such as zone device block details etc. user can add new LED data in this interface also.

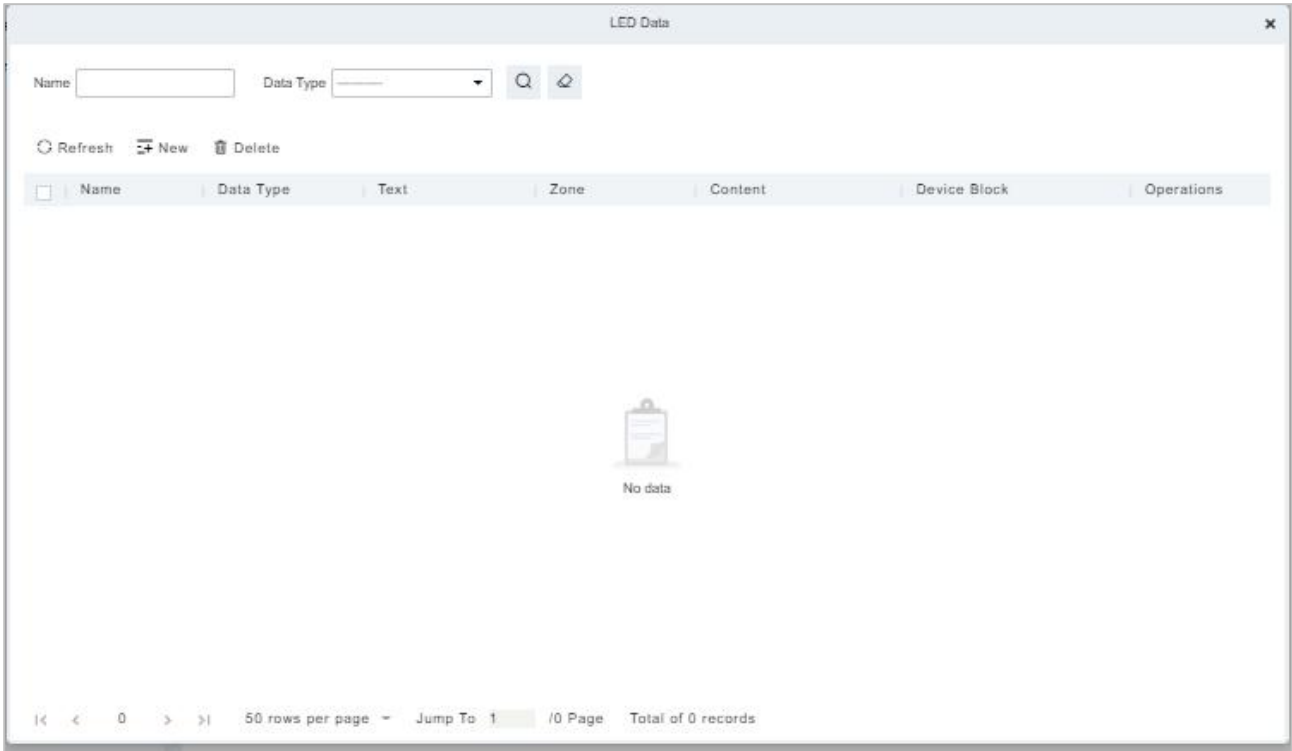

Figure 15-63 LED Data

15.4.1.4 Manually defined content

Select a device and click **Manually Defined Content**. The page is displayed as follows:

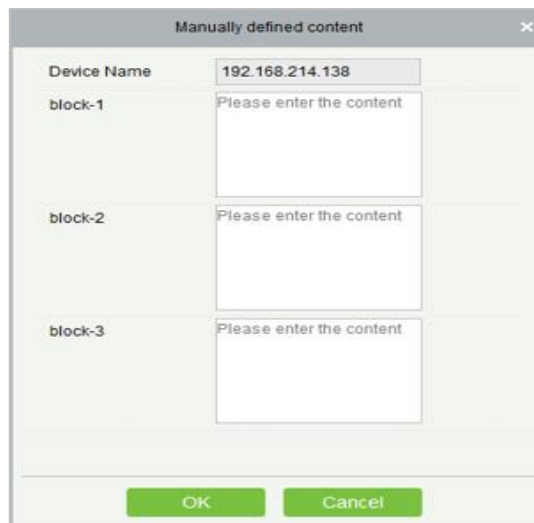

Figure 15-64 Manually Defined Content Option

Notes:

At least one block must be selected for the distribution of manually defined content.

After the manually defined content is selected, the access control module cannot send data to the LED device.

Contact the technical support team for the intermediate table, line notification, active directory page, and other materials.

15.4.1.5 LED Template Management

Through this function, you can create a template for the blocks. This template you can directly use at the time of adding an LED device. When you are adding an LED device, then after defining the dimensions of the block, you will be prompted to save the template as shown below:

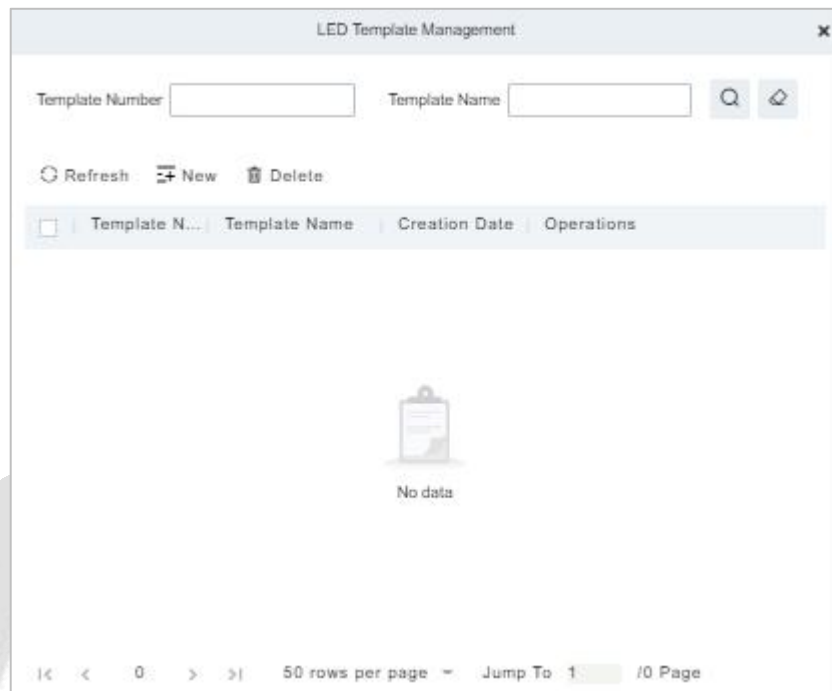

Figure 15-65 LED Template Management

15.4.1.6 Synchronize All Data to Devices

Synchronize the LED block layout and LED data set in the system to the device. Select a device, click **Synchronize All Data to Devices**, and then click **Synchronize** to synchronize the data.

15.4.1.7 Edit

Click a device name or **Edit** under operation to go to the edit page. After editing the device, click **OK** to save the setting.

15.4.1.8 Enable/Disable

Select a device and click **Enable/Disable** to start/stop using the device. If the device is enabled, data is transmitted to the device. Otherwise, no data is transmitted to the device.

15.4.1.9 Restart

After you restart the device, the LED control card system will be restarted, data on the screen is cleared and data saved in the system is restored. After the device is successfully restarted, click **Synchronize All Data to Devices** to display all distributed content on the LED screen.

15.4.1.10 Modify IP Address

Modify the IP address of the device. The default IP address of the control card is 192.168.1.222.

15.4.2 Digifort Camera

It's integrated with third-party camera management system and the client uses "Digifort" to manage the cameras.

15.4.2.1 Sync with Server

It will help you to synchronize device with the server.

15.4.2.2 Delete

Click **Third Party Integration > Digifort Camera**, then select a Device Name, and click **Delete > OK** to delete.

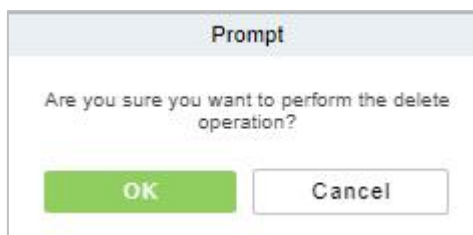

Figure 15-66 Delete Option

15.4.2.3 Parameters

Click **Third Party Integration > Digifort Camera > Parameters >** to update the server details.

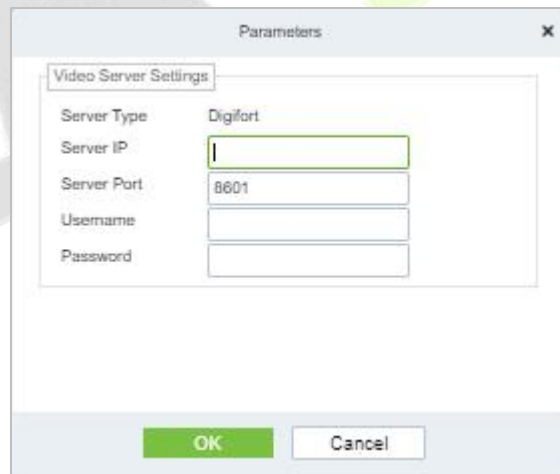

Figure 15-67 Digifort Camera Device Parameters

Parameter	Description
Server Type	By default, the server settings "Digifort".
Server IP	Enter the Arteco Server IP.
Server Port	Enter the Arteco Server Port.Default value is 8601
Username	Enter the Arteco User Username.
Password	Enter the User Password.

Table 15-7 Description Digifort Camera Parameter

15.4.3 Line Notification

Click **System > Third Party integration > Line Notification** to enter the interface:

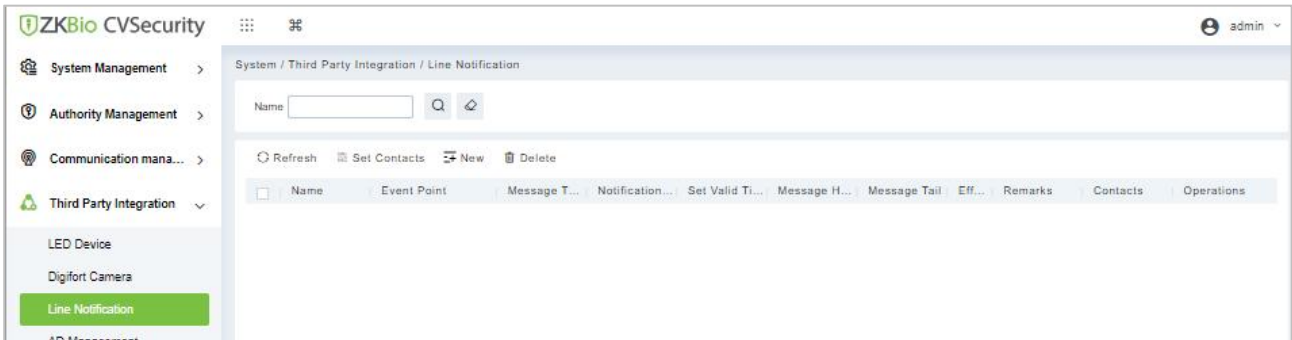

Figure 15-68 Line Notification Interface

15.4.3.1 Refresh

Click **Refresh** at the upper part of the list to load the new temporary line Notification.

15.4.3.2 Set Contacts

Step 1: Add Line Integration. Log in ZKBio CVSecurity and go to **System > Third Part Integration > Line Integration**, then click **Set Contacts**.

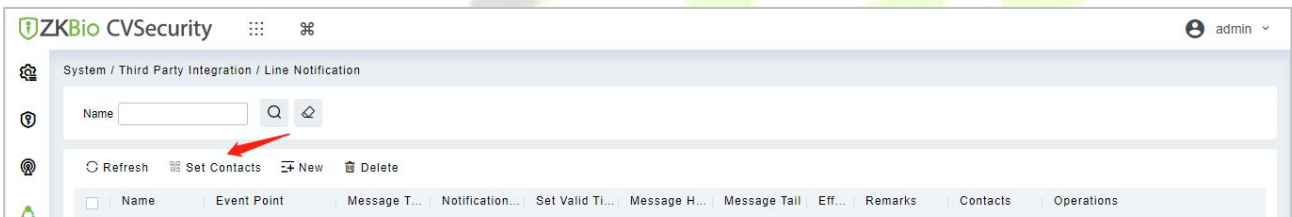

Figure 15-69 Set Contacts Option

Step 2: After the windows is displayed, please click **New**.

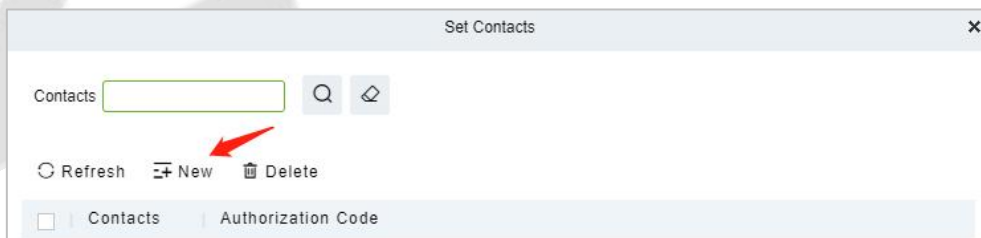

Figure 15-70 Add Contacts Option

Step 3: After the windows is displayed, please click **Click to enter**.

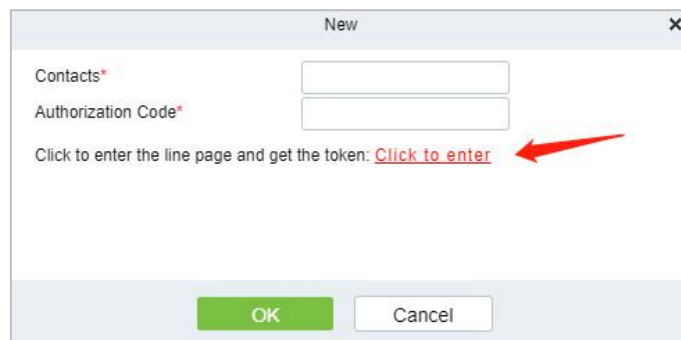

Figure 15-71 New Option

Step 4: Line web page, please use the account and password of line to log in.



Figure 15-72 Line Interface

Step 5: After login, slide down and click **Generate token**.

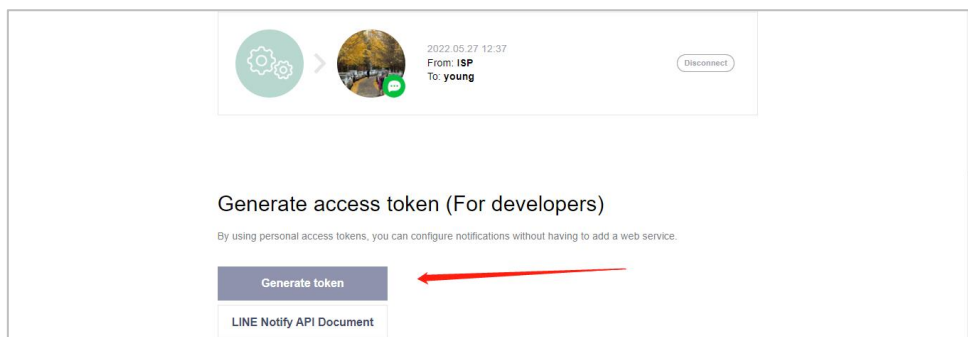

Figure 15-73 Generate Token option

Step 6: Fill in the name of token and select the group you created earlier, then click Generate token

Note: The group you selected is used to receive Line-linked messages, please make sure that the group members do not disclose information security.

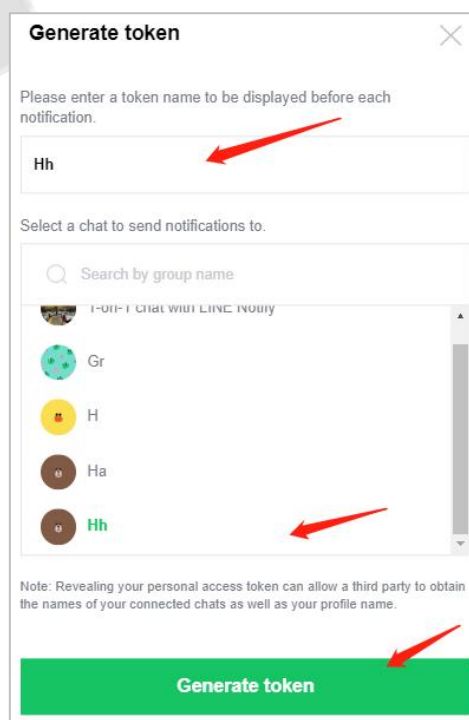

Figure 15-74 Generate Token Option

Step 7: Please click **Copy**.

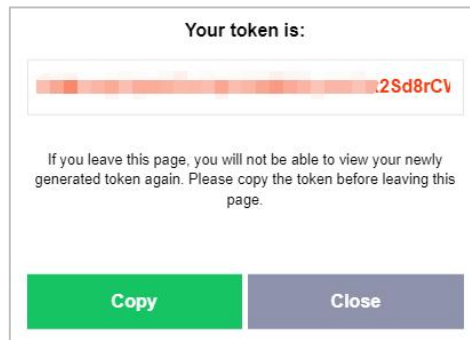

Figure 15-75 Token Interface

Step 8: Back to **ZKBio CVSecurity > System Page**, paste the Authorization Code and fill in Contacts.

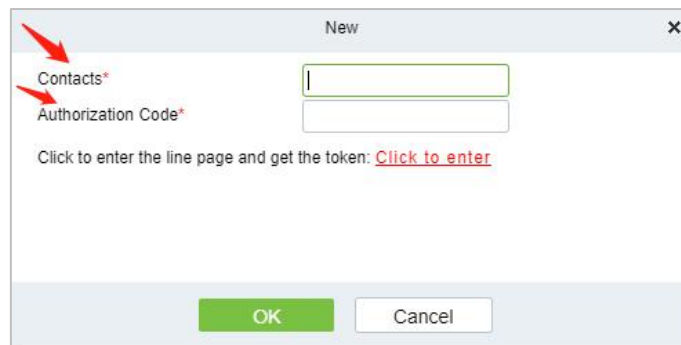

Figure 15-76 Add Contact Option

15.4.3.3 New

Step 1: Click **Third Party > Line Notification > New** to enter the Add Levels editing interface:

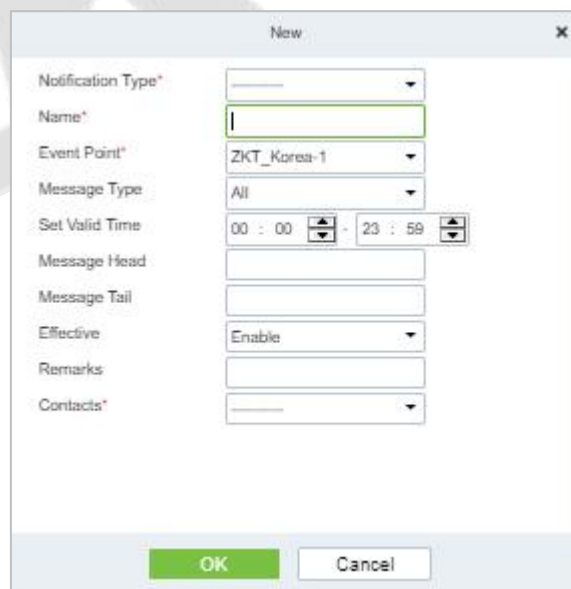

Figure 15-77 Add Line Notification

Step 2: Fill in all the required details and save. Once saved, you will get the template at the Line Notification device adding interface.

15.4.3.4 Delete

Click **Third Party > Line management**, then select a receiver, and click **Delete > OK** to delete.

15.4.4 AD Management

15.4.4.1 Server Configuration

Operation Step:

Step 1: In the **System** module, select **Third Party Integration > AD Management**.

Step 2: In the **AD Management** interface, fill in the **Server Configuration** as required in the details below.

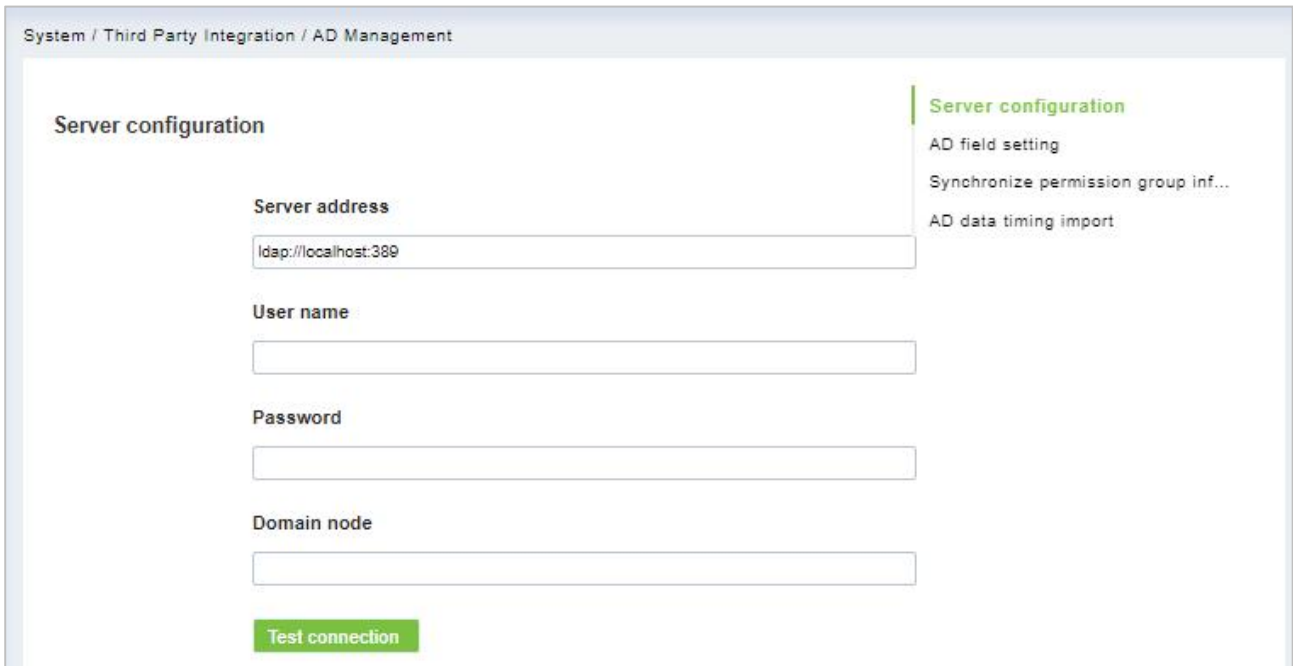

The screenshot shows the 'Server configuration' page within the 'AD Management' interface. The breadcrumb trail at the top reads 'System / Third Party Integration / AD Management'. The main heading is 'Server configuration'. On the right, there is a sidebar menu with 'Server configuration' selected, and other options: 'AD field setting', 'Synchronize permission group inf...', and 'AD data timing import'. The main form contains four input fields: 'Server address' (with the value 'ldap://localhost:389'), 'User name', 'Password', and 'Domain node'. A green 'Test connection' button is located at the bottom of the form.

Figure 15-78 Ad Management Interface

15.4.4.2 AD Field Setting

Operation Step:

Step 1: In the **System** module, select **Third Party Integration > AD Management**.

Step 2: In the **AD Management** interface, fill in the **AD field setting** as required in the details below.

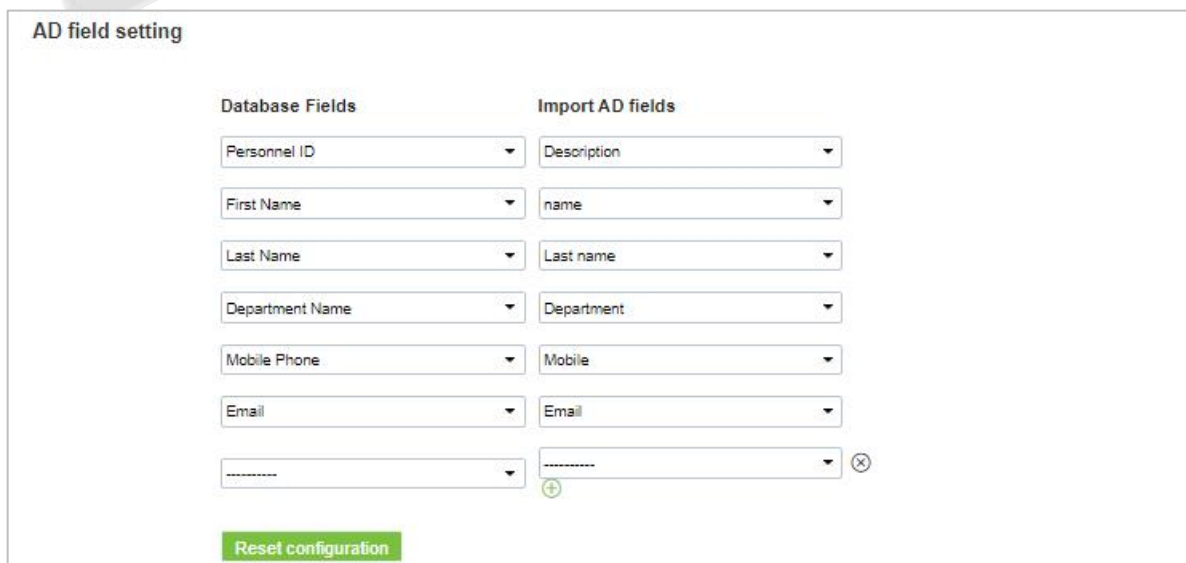

The screenshot shows the 'AD field setting' page. It features two columns of dropdown menus. The left column is titled 'Database Fields' and includes: 'Personnel ID', 'First Name', 'Last Name', 'Department Name', 'Mobile Phone', 'Email', and an empty field with a plus icon. The right column is titled 'Import AD fields' and includes: 'Description', 'name', 'Last name', 'Department', 'Mobile', 'Email', and an empty field with a plus icon and a close icon. A green 'Reset configuration' button is at the bottom.

Figure 15-79 AD Field Setting

15.4.4.3 Synchronize Permission Group Information

Operation Step:

Step 1: In the **System** module, select **Third Party Integration > AD Management**.

Step 2: In the **AD Management** interface, fill in the **Synchronize permission group information** as required in the details below.

Synchronize permission group information

Synchronization permission group

Synchronize members in permission group

Domain Node

⚠ Please perform the synchronization permission group first, otherwise the synchronization may fail.

Test connection

Figure 15-80 Synchronize Permission Group Information

15.4.4.4 AD Data Timing Import

Operation Step

Step 1: In the **System** module, select **Third Party Integration > AD Management**.

Step 2: In the **AD Management** interface, fill in the **AD data timing import** as required in the details below.

AD data timing import

Incremental synchronization (minutes)

Import now

Global synchronization

Every Day Dots

Import now

OK

Figure 15-81 AD Data Timing Import

15.4.5 SMS Management

The SMS Management feature helps in sending text messages to the personnel in case of any access or elevator event. If the checkbox is selected, the message will be sent to the corresponding person.

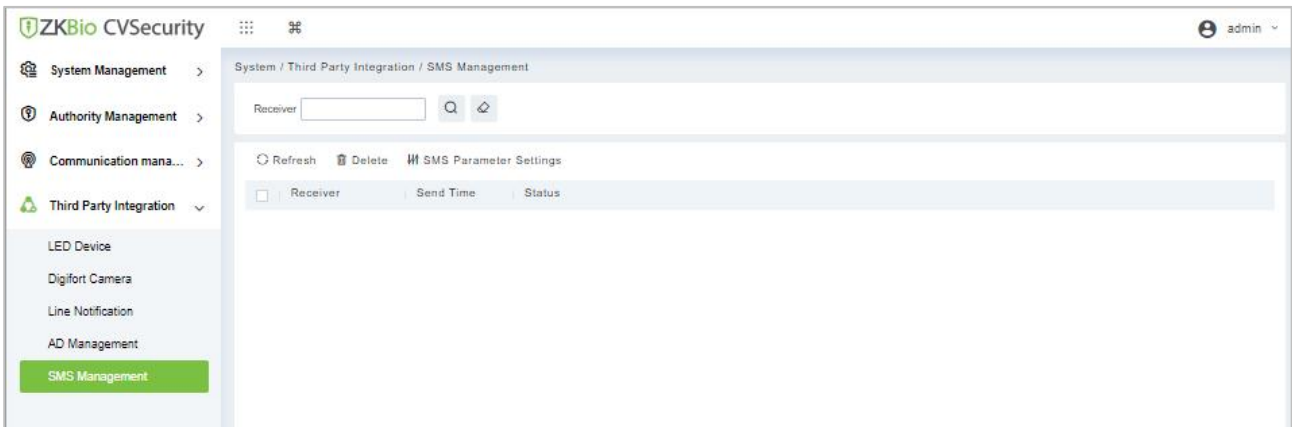

Figure 15-82 SMS Management Interface

15.4.5.1 Refresh

Click **Refresh** at the upper part of the list to load a new temporary SMS Management.

15.4.5.2 Delete

Click **Third Party > SMS Management**, then select a receiver, and click **Delete > OK** to delete.

15.4.5.3 SMS Parameter Settings

Supports sending text message to Personnel once any access or elevator event occurs.

After selecting the checkbox next to the Mobile Number, the system will send an email to the relevant person once access or an elevator event occurs.

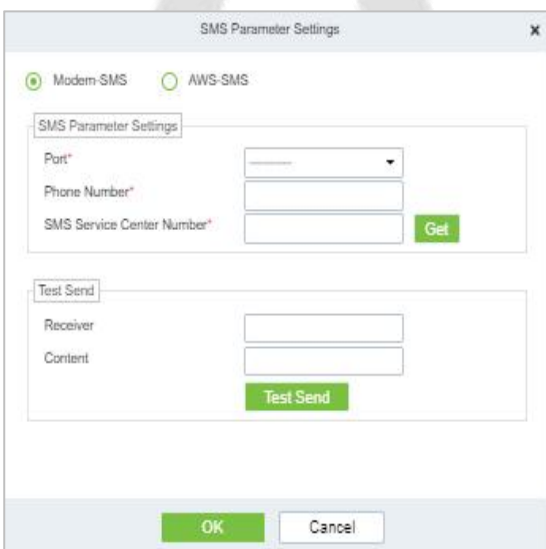

Figure 15-83 Modern SMS Parameter Setting

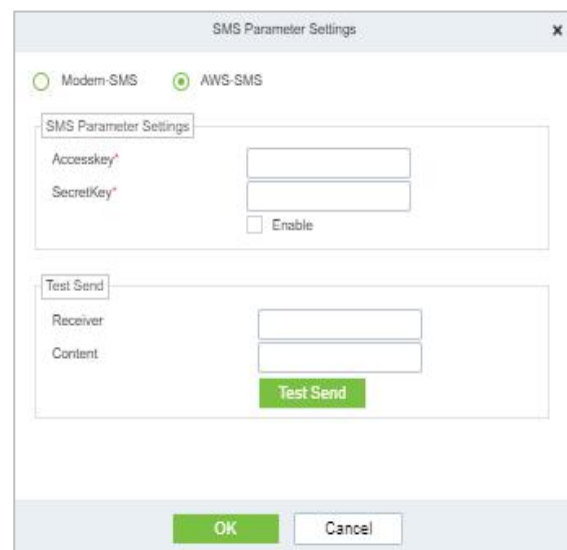

Figure 15-84 AWS-SMS Prameter Settings

16 FaceKiosk

16.1 Facekiosk Device

16.1.1 Device

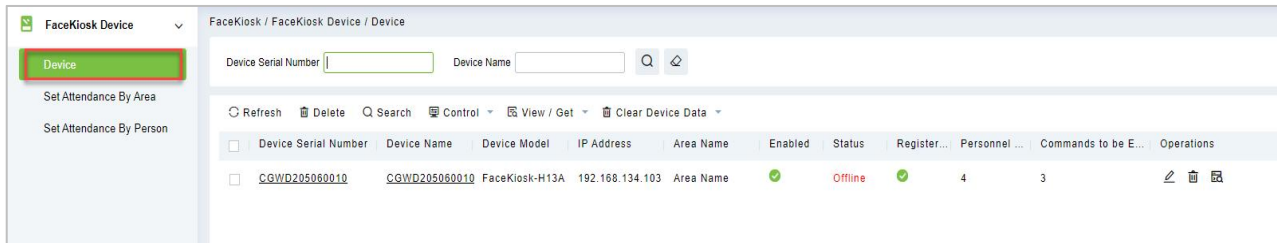

Figure 16-1 Device

16.1.1.1 Delete

Select one or more devices and click **Delete** at the upper part of the list and click **OK** to delete the selected facekiosk device. Click **Cancel** to cancel the operation or click **Delete** in the operation column to delete a single device.

16.1.1.2 Search Device

In the tool bar, select the “**Search device**” menu. Add the device to the software server.

Note: User need to entry the hardware device and setting some paramter which is supported to setting the software server address.

16.1.1.3 Control

Click **FaceKiosk Device > Device**, then select Control to Enable/ Disable, Reboot, synchronize software Data, and Issued QRCode Address of the device.

Function	Description
Enable/ Disable	Select device, click Disable/ Enable to stop/ start using the device. When communication between the device and the system is interrupted or device fails, the device may automatically appear in disabled status. After adjusting local network or device, click Enable to reconnect the device and restore device communication.
Reboot Device	It will reboot the selected device
Synchronize software Data to the Device	Synchronize data of the system to the device. Select device, click Synchronize All Data to Devices and click OK to complete synchronization.
Issued QRCode Address	Select the Issued QRCode Address.

Table 16-1 Device Control

16.1.1.4 View / Get

Click **FaceKiosk Device > Device**, then select View/Get to Get Device Option, View Device Parameters, Reupload Data, and to Gets the Specified Person Data.

Parameters	Description
Get Device Option	It gets the common parameters of the device. For example, get the firmware version after the device is updated.
View Device Parameters	Show the capacity detail.
Reupload Data	Select the device in which you want to upload data. Click to enter the check box to upload the data type: attendance record/personnel information/attendance photo, click the confirmation to get such information again from the device.
Gets the Specified Person Data	It gets the Specified person Data from the device.

Table 16-2 Device View/Get

16.1.1.5 Clear Device Data

Click **FaceKiosk Device > Device**, then select Clear Device Data to clear Device Command, Verification Photo and Validation Record.

Parameters	Instruction
Clear Device Command	Select the device to be cleared. It clears the operation command issued by the software in the setting.
Clear Verification Photo	Select the device. This function will clear all the verificationn photo records from the device.
Clear Validation Record	Select the device. This function will clear all the validation data records from the device.

Table 16-3 Clear Device Data

16.1.1.6 Edit

Click advertisement resources or **Edit** in the operation column to go to the Edit page. Make modifications and click **OK** to save modifications.

16.1.2 Set Attendance by Area

Click **FaceKiosk > FaceKiosk Device**, then Select **Set Attendance by Area**.

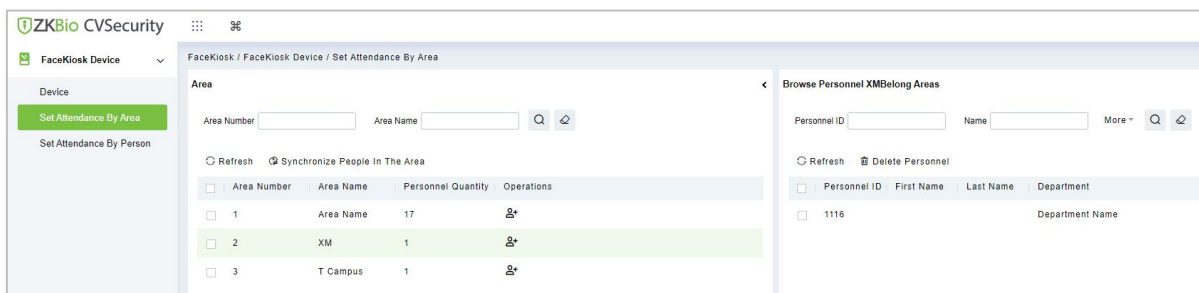

Figure 16-2 Set Attendance by Area

16.1.2.1 Synchronize People in the Area

Click > **FaceKiosk** > **FaceKiosk Device** > **Set Attendance by Area**, then select **Synchronize People in The Area**.

Click **OK** to save and exit.

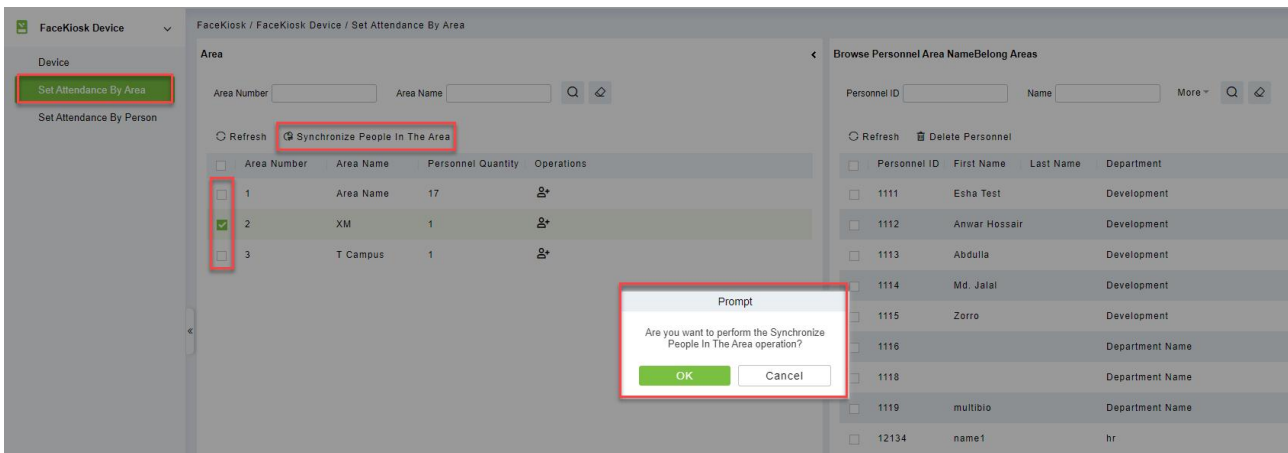

Figure 16-3 Set Attendance by Area

16.1.3 Set Attendance by Person

Click > **FaceKiosk** > **FaceKiosk Device**, then Select **Set Attendance by Person**.

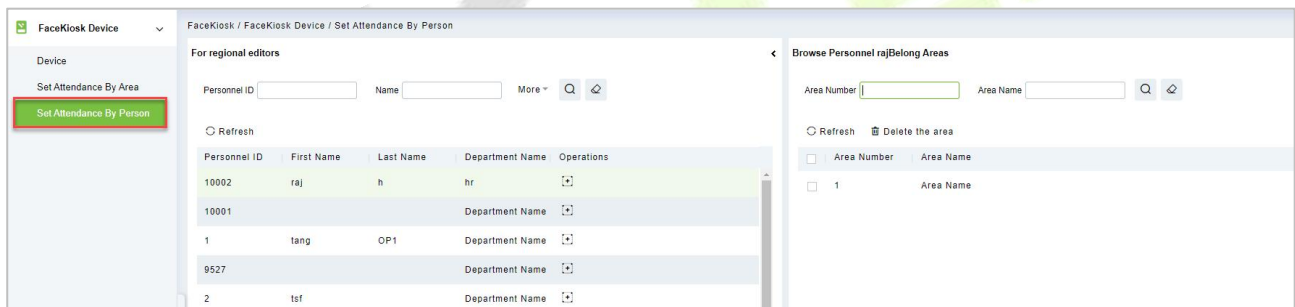

Figure 16-4 Set Attendance by Person

16.2 Media Advertisement Resources

16.2.1 Advertisement Resources

Click > **FaceKiosk** > **Media Advertisement Resources**, then Select **Advertisement Resources**.

In the Advertisement resources module, it can support to create/edit/delete advertisement resources.

16.2.1.1 Add (New)

Support to upload some new advertisement resources to software server.

The 'New' dialog box has the following fields and controls:

- Medium Type***: A dropdown menu with 'Image' selected.
- Media Resource Type***: A dropdown menu with 'Local Resource' selected.
- Media Name***: A text input field.
- File Upload***: A green 'Browse' button and the text 'Not Uploaded'.

At the bottom of the dialog are 'OK' and 'Cancel' buttons.

Figure 16-5 Media advertisement Resources

16.2.1.2 Edit

Click device name or **Edit** in the operation column to go to the Edit page. Make modifications and click **OK** to save modifications.

16.2.1.3 Delete

Select one or more advertisement resources and click **Delete** at the upper part of the list and click **OK** to delete the selected advertisement resources. Click **Cancel** to cancel the operation or click **Delete** in the operation column to delete a single advertisement resource.

16.2.2 Advertisement Settings

Click > **FaceKiosk** > **Media Advertisement Resources**, then Select **Advertisement Settings**.

This module support to create **Edit** and **Delete** the advertising.

The 'Advertisement Settings' page includes:

- Left Sidebar**: 'Advertisement Settings' is highlighted.
- Search Bar**: 'Device Name' with search and refresh icons.
- Table**:

Device Serial Number	Device Name	Operations
CGWD205060010	CGWD205060010	[Edit]
- Right Panel (Ad)**:
 - 'Media Name' search bar.
 - 'Refresh' and 'Delete' buttons.
 - Table:

Media Name	Medium Type
test	Image

Figure 16-6 Advertisement settings

16.3 FaceKiosk Reports

16.3.1 Verification Record

Click > **FaceKiosk** > **FaceKiosk Reports**, then **Verification Record** to view specified events in specified condition.

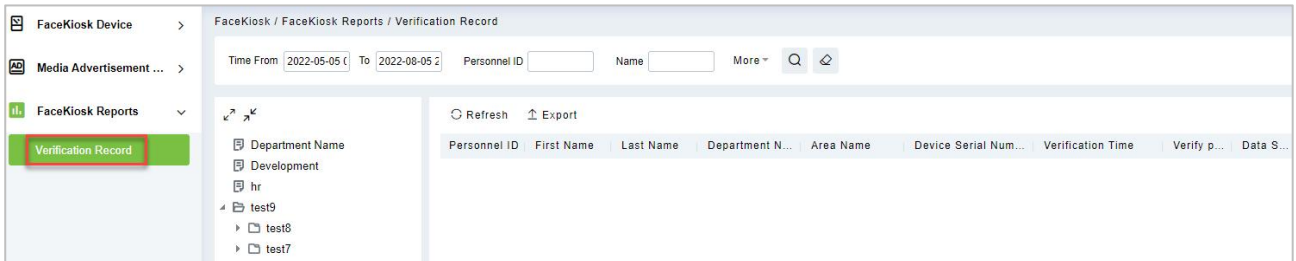

Figure 16-7 Verification Record

16.3.1.1 Export

Export the operation log records, save to local. You can export to an Excel, PDF, TXT or CSV file. Click Export See the following figure.

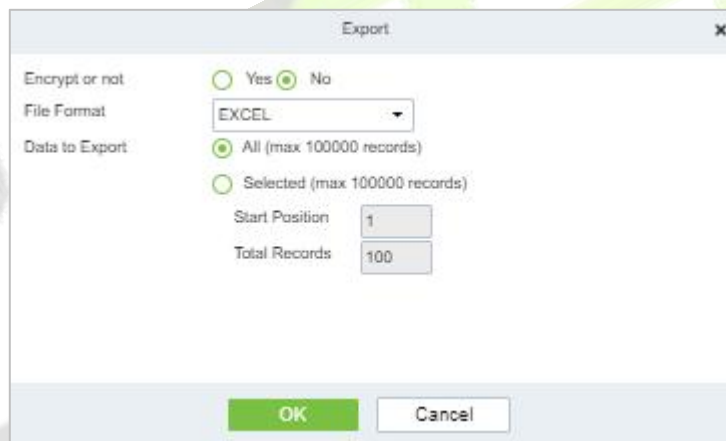

Figure 16-8 Verification Record

17 Hotel System

It provides hotel service management functions covering check-in, overstay, check-out, rate settlement, and lock setup and management.

Operation Guide

It helps you quickly understand how to quickly navigate to specific function pages and configure and use the hotel management software.

17.1 Device Management

For communication between the system and device, data uploading, configuration downloading, device and system parameters shall be set. Users can edit access controllers within relevant levels in the current system; users can only add or delete devices in Device Management if needed.

17.1.1 Device

Operation Steps:

Step 1: In the **Hotel** module, select **Device management > Device**.

Step 2: On the device interface, click the **Search** button to pop up a search box.

Step 3: Click "**Start Search**" in the search box to display the **Access Devices** that can be added, as shown in Figure 17-1.

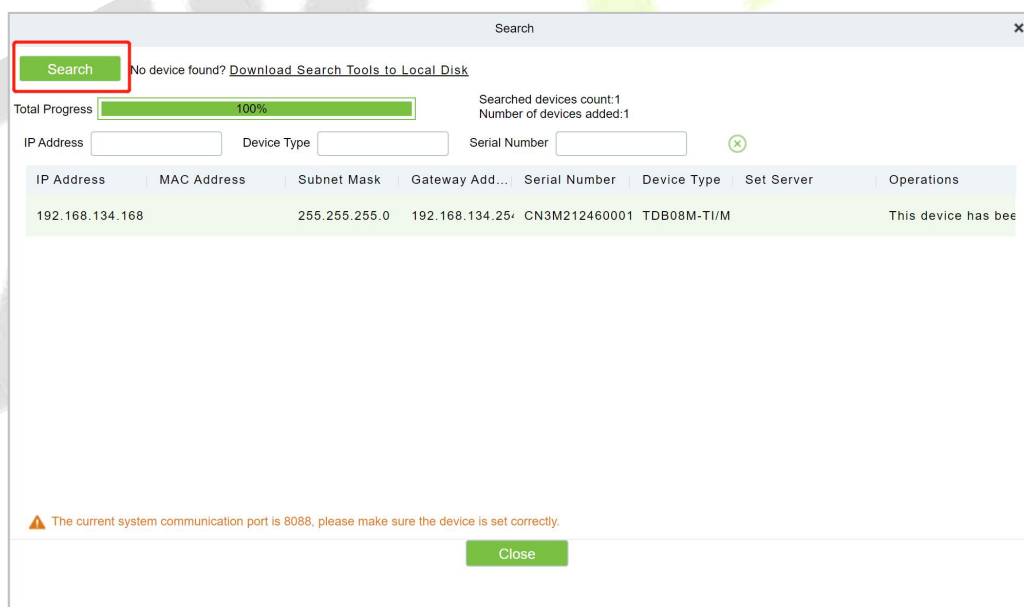

Figure 17-1 Device Search and Add Interface

Step 4: Optional: Modify the IP address of the **Access Control** device, click "**Modify IP Address**", the device will be restarted after modifying the IP address, and the IP address modification will be completed after the restart.

Step 5: For the searched devices, click the **Add** button in the operation bar to add the device.

Step 6: Click **OK** to complete the operation of adding devices. After the operation is completed, the device will restart, and the device will be added after the restart is complete.

Step 7: Click **Close** to close the device search and add interface.

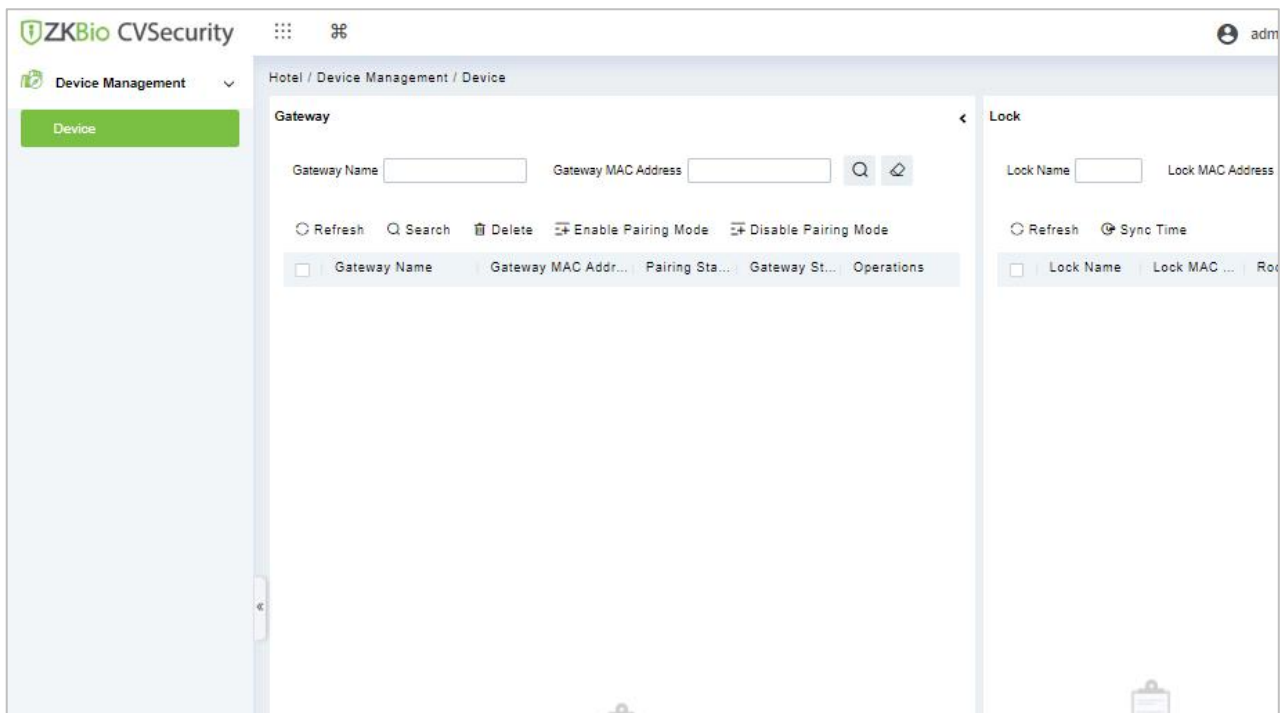

Figure 17-2 Device Interface

- **Enable Paring Mode**

Select device, click **Enable** to start using the device. When communication between the device and the system is interrupted or device fails, the device may automatically appear in disabled status.

- **Disable Paring Mode**

Select device, click **Disable** to stop using the device. When communication between the device and the system is interrupted or device fails, the device may automatically appear in disabled status. After adjusting local network or device, click **Enable** to reconnect the device and restore device communication.

- **Synchronize Time**

It will synchronize device time with server's current time.

- **Emergency Unlock/ Cancel Emergency Unlock**

A master card can be used to unlock all the rooms of the hotel within its validity period. By default, Disable Indoor Locked is selected. You can specify whether to enable the Always Open mode. And you can cancel the by clicking **Cancel Emergency Unlock**.

- **Get Unlock Records**

Select device, click **Get Unlock Records** to start using the device. We can get the unlock doors records.

- **Enable**

Enable the device. Only enabled devices can be normally used. Select the device to be enabled and click **Enable**.

- **Disable**

Disabled devices cannot be normally used. Select the device to be disabled and click **Disable**.

- **Delete**

Select one or more locks to be deleted and click **Delete** to delete lock in batches.

17.2 Room Management

17.2.1 Room Monitor

The function allows users to handle room services and check the hotel room occupancy, such as the total number of rooms, number of available rooms, and number of available rooms of a specific room type.

Operating Steps:

Step 1: In the **Hotel** module, click **Room Management > Room Monitor**.

Step 2: You can view relevant monitoring card and data statistics in the monitoring room interface, as shown in Figure 17-3.

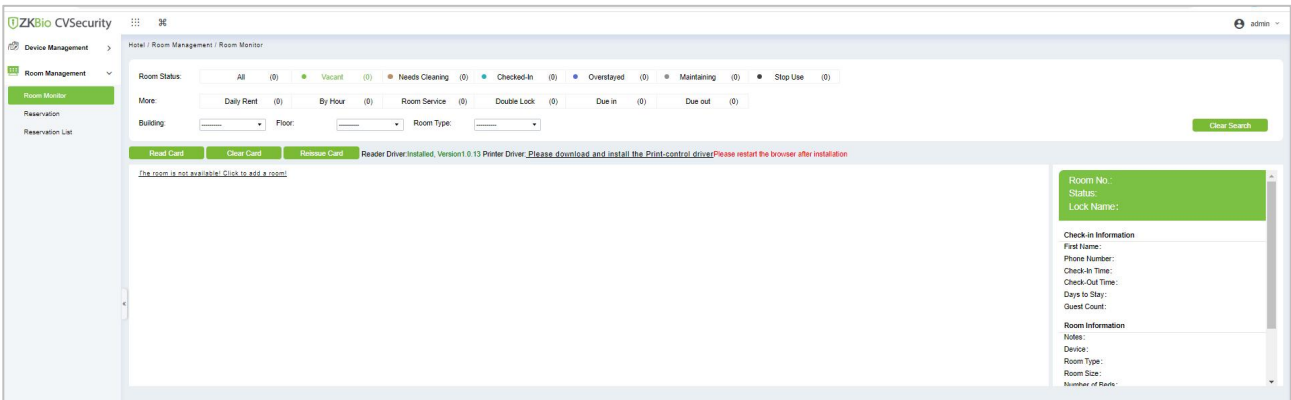

Figure 17-3 Room Monitoring

17.2.2 Reservation

You can check the check-in and reservation status of all rooms in a specified period and process room reservation.

Choose **Hotel Management > Room Management > Reservation**. The page shown in the following figure appears.

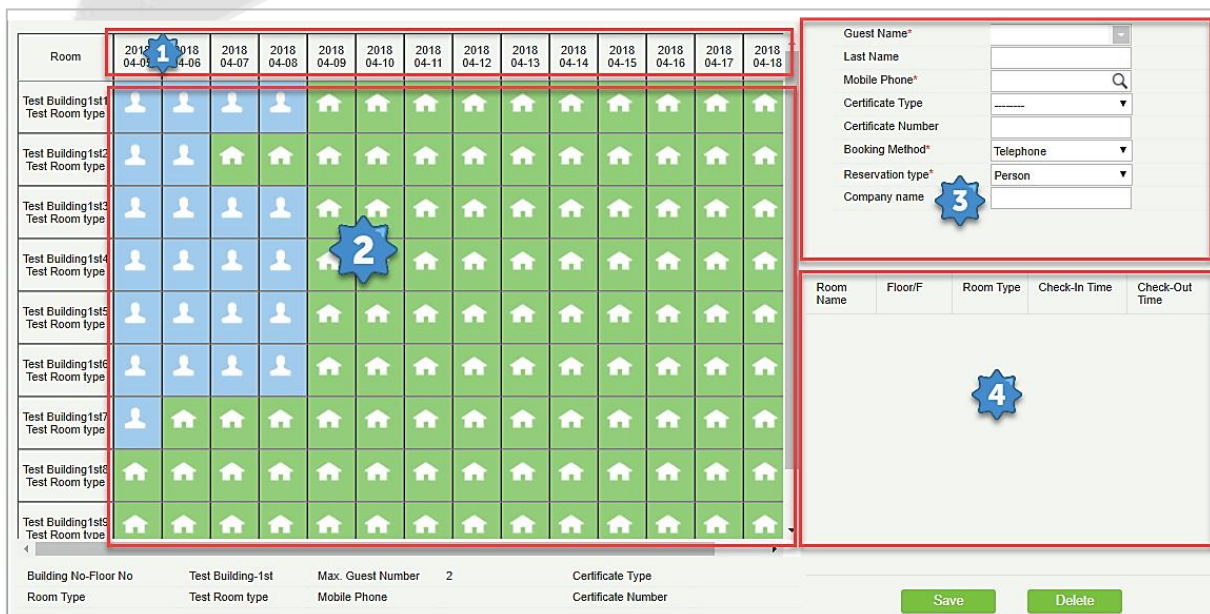



Figure 17-4 Reservation

Page Description:

(Available dates): By default, a 15-day period (starting from the current system date) is displayed. You can change the displayed period with the Reservation Date Range parameter on the Hotel Information page.

The room reservation time ranges from 12:00 on the reservation start date to 12:00 on the reservation due date. You can change the time point with the Default Check-Out Time parameter on the Hotel Information page.

(Available rooms): All rooms in the hotel are displayed. You can specify the start and end time and room type to query for a required room.

Room status  indicates that the room can be reserved for the time period.

Room status  indicates that the room is occupied in the time period and cannot be reserved.

Room status  indicates that the room has been reserved for the time period.

Note: If a room is used by guests, and will be checked out in the reservation period, the room will be displayed among the available rooms, but cannot be reserved before it is checked out.

Guest information of the reservation.

Information about the rooms selected for reservation.

17.2.2.1 Reservation process

Step 1: Click the room and date for reservation. The selected date of a room turns into red as . You can click the room and date again to cancel the selection. You can select multiple rooms of the same date, multiple dates (continuous only) of one room, or multiple dates (continuous only) of multiple rooms. After selection, the information about the selected rooms are listed in 4 in the right part of the Reservation Center page.

Step 2: Fill in the guest information, including the name, mobile phone, certificate number, and the booking method (telephone or reception desk).

Step 3: Click **Save**.

17.2.3 Reservation List

You can query, edit, delete, and handle check-in for a reservation.

Choose **Hotel Management > Room Management > Reservation List**. The page shown in the following figure appears.

You can also enter the guest's name and mobile phone number to query for a required reservation.

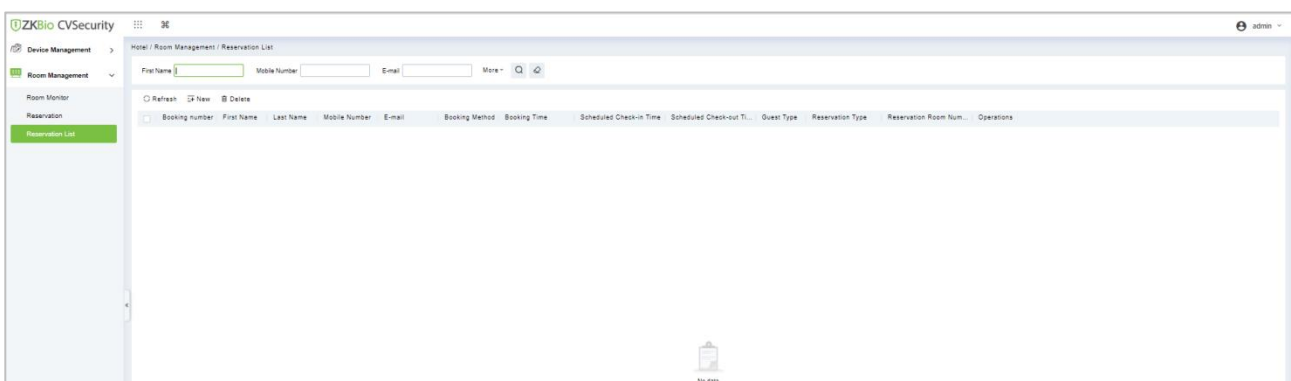

Figure 17-5 Reservation list

17.2.3.1 Managing Check-in

Select the guest's name of a reservation, click **Check-In** under **Operations**. The **Individual Check-In** page appears.

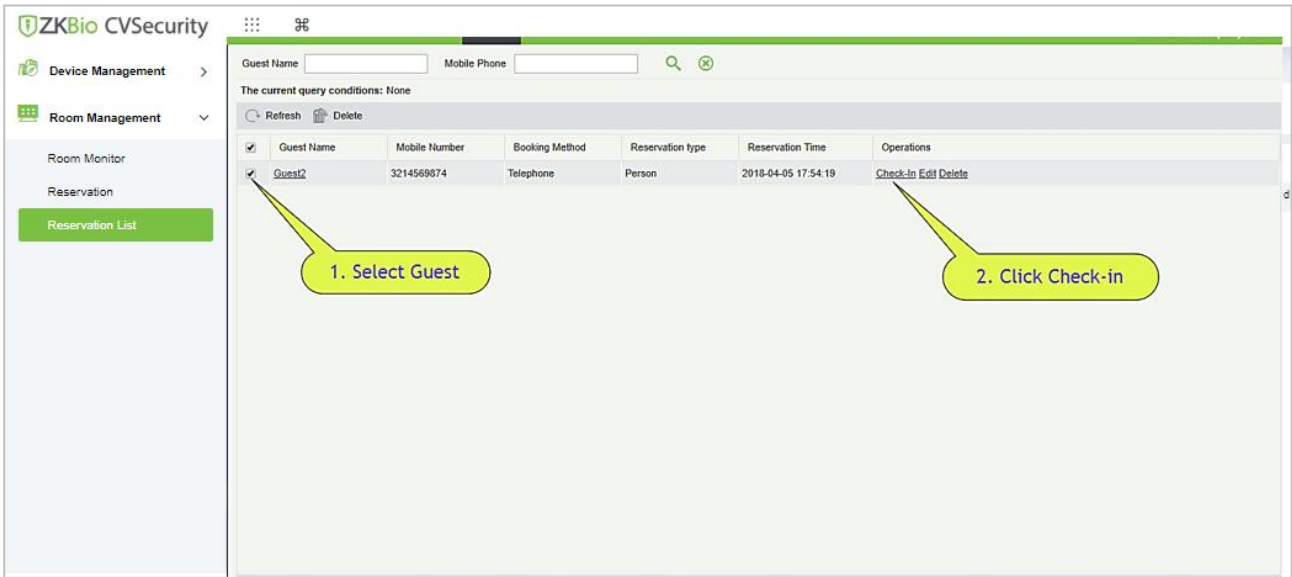

Figure 17-6 Manage check -in

The 'Individual Check-In' form is displayed in a modal window. It contains the following fields and controls:

- Room Name*: Test Building1st2
- Certificate Type*: ID
- Certificate Number*: 54445242
- Guest Name*: Guest2
- Last Name: xyz
- Gender: ----
- Mobile Phone: 3214569874
- Booking: 3214569874
- E-Mail: [Empty]
- Emergency Contact: Please enter mobile phone
- Home Address: [Empty]
- Checkin Type*: Daily Rate Room Hourly Rate Room
- Stay Days*: 1
- Guest Count: 1
- Check-In Time: 2018-04-06 10:08:20
- Check-Out Time: 2018-04-06 12:00:00
- Discount (%): [Empty]
- Daily Rate*: 20.0
- Deposit Amount*: 10.0
- Amount Payable*: 30.0

At the bottom of the form are two buttons: 'Check-In' and 'Cancel'. On the right side, there is a photo capture area with a placeholder image, the text '(Optimal Size 120*140)', and 'Browse' and 'Capture' buttons.

Figure 17-7 Individual check -in

The system automatically loads the reservation information of the room. Modify and complete the guest information and click Check-In. The **Registration or Issuing** page appears as shown below.

Registration or Issuing

Room Name: Test Building1st2
Room Type: Test Room type
Check-In Time: 2018-04-06 10:08:20
Check-Out Time: 2018-04-07 12:00:00
Only registered, no card:
Certificate Type*: ID
Certificate Number*: 54445242
Guest Name*: Guest2
Last Name: xyz
Elevator/Access Control:

Registered Card Quantity: 0 Remaining Guest Quantity: 1

Guest Name	Last Name	Certificate Type	Certificate Number	Card Number
------------	-----------	------------------	--------------------	-------------

Write Card **Complete**

Figure 17-8 Registering or issuing

Place the guest card on the card writer and click **Write Card** and complete to complete check-in.

Notes: You cannot process check-in for an expired reservation. Check-in can only be processed on site. For details, see Individual check-in in section. The guest can check in before the reserved time.

17.2.3.2 Editing/Deleting Reservation

Select the guest’s name of a reservation, click **Edit** under Operations.

ZKBio CVSecurity

Device Management >
Room Management >
Room Monitor
Reservation
Reservation List

Guest Name: Mobile Phone:

The current query conditions: None

Refresh Delete

Guest Name	Mobile Number	Booking Method	Reservation type	Reservation Time	Operations
Guest2	3214569874	Telephone	Person	2018-04-05 17:54:19	Check-in Edit Delete

1. Select Guest

2. Click Edit

Figure 17-9 Editing and Deleting Reservation list

The below reservation page will be displayed. You can change a room or modify the guest information for the reservation. Modify the details accordingly and click **Save**.

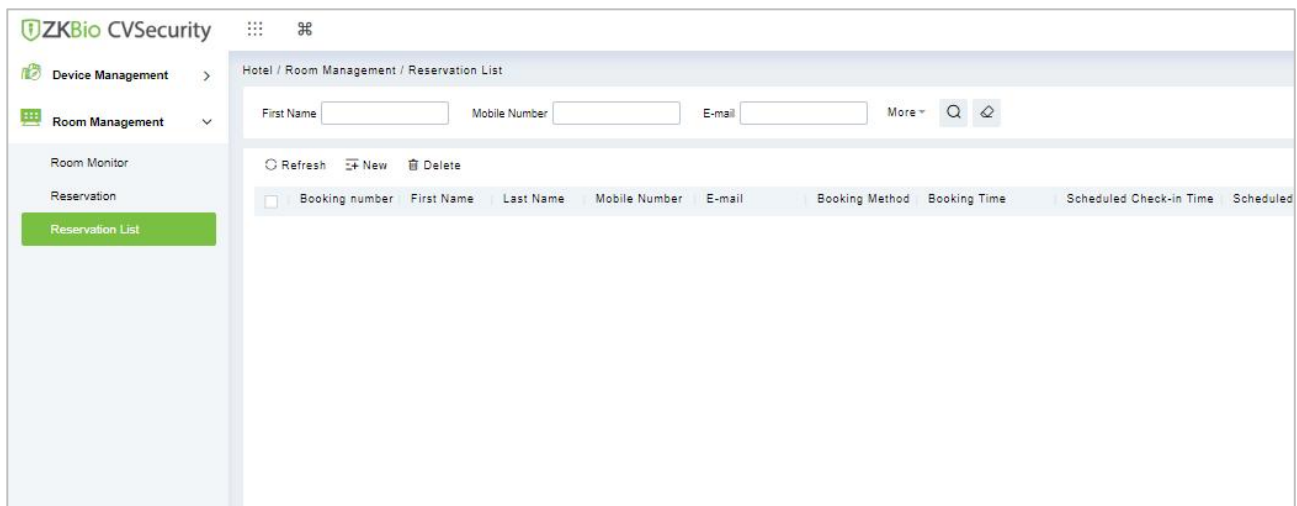

Figure 17-10 Edit Reservation list

17.2.3.3 Delete

Select the guest's name of a reservation, click **Delete** under **Operations** or the **delete** button on the top of the list to delete the reservation. Click **OK** to confirm the delete operation.

17.3 Card Management

You can create different types of cards for setting and managing room locks based on daily hotel business management requirements. Holders of the cards are employees of the hotel. You need to add the holders using the HR module and specify their departments using the hotel module, so that you can select the holders when issuing management cards.

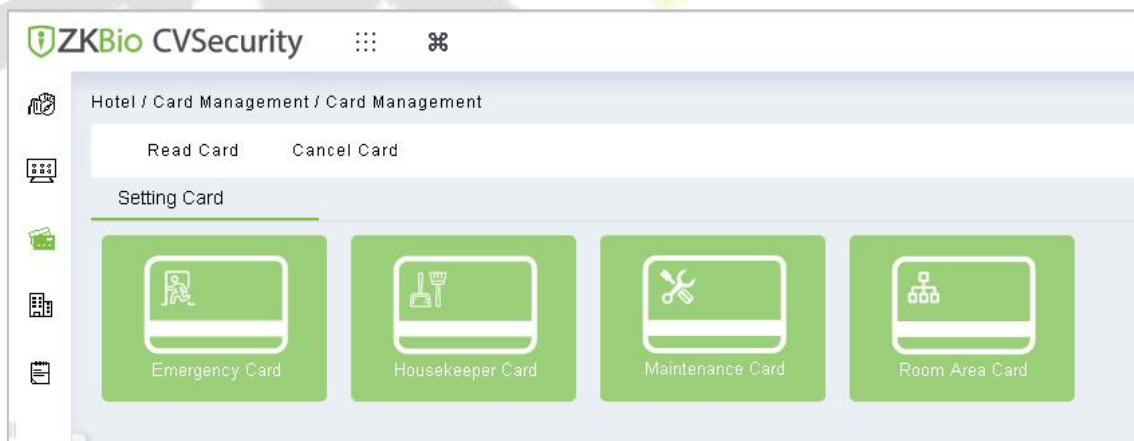

Figure 17-11 Card Management

17.3.1 Read Card

In the **Hotel** module, click **Card Management > Read Card**. After download the reader driver, you can read the card.

17.3.2 Cancel Card

In the **Hotel** module, click **Card Management > Conceal Card**. After download the reader driver, you can cancel the card.

17.3.3 Setting Card

You can set the basic information, including authorization, time, room number, and area information about locks of the hotel.

17.3.3.1 Room Area Card

In the **Hotel** module, click **Card Management > Setting Card > Room Area Card**. A room area card is used to unlock rooms in a specified area. If a room is within the specified area, the card can unlock the room.

Figure 17-12 Room area card

Parameter	Description
Card Holder Name	Enter the Card holder name
Card Expiration Time	Display the card expiration time
Hotel Facility	Display the hotel facilities.

Table 17-1 Parameter Setting Card

17.3.3.2 Emergency card

In the **Hotel** module, click **Card Management > Setting Card > Emergency Card**. A master card can be used to unlock all the rooms of the hotel within its validity period. By default, **Disable Indoor Locked** is selected. You can specify whether to enable the Always Open mode.

Figure 17-13 Emergency Card

Parameter	Description
Card Holder name	Enter the Card holder name
Card Expiration Time	Display the card expiration time

Table 17-2 Parameter emergency card

17.3.3.3 Maintenance Card

In the **Hotel** module, click **Card Management > Setting Card > Maintenance Card**. A maintenance card can be used to maintain and manage room locks of the hotel.

Figure 17-14 Maintenance Card

Parameter	Description
Card Holder name	Enter the Card holder name
Card Expiration Time	Display the card expiration time
Building Name	Display the building Name.
Floor Name	Enter the floor name and number.

Table 17-3 Parameter Maintenance Card

17.3.3.4 House Keeping Card

In the **Hotel** module, click **Card Management > Setting Card > House Keeping Card**. A house keeping card can be used to unlock rooms in a specified area in unlocking mode within its validity period.for house keeping.

Figure 17-15 Housekeeper Card

Parameter	Description
Card Holder name	Enter the Card holder name
Card Expiration Time	Display the card expiration time
Building Name	Display the building Name.
Floor Name	Enter the floor name and number.

Table 17-4 Parameter Housekeeper Card

17.3.3.5 Employee Card

In the **Hotel** module, click **Card Management > Setting Card > Employee Card**. You can create various access/elevator control cards, such as master cards and emergency cards for hotel personnel to manage hotel services.

17.4 Hotel Management

17.4.1 Hotel Settings

You can set the basic information about a hotel, including its name, address, phone number, fax number, zip code, website address, and email address. You can also set the function parameters regarding the check-in time, check-out time, check-out reminder, and access/elevator control permissions.

Click **Hotel Management > Hotel Info Settings**. The page shown in the following figure appears.

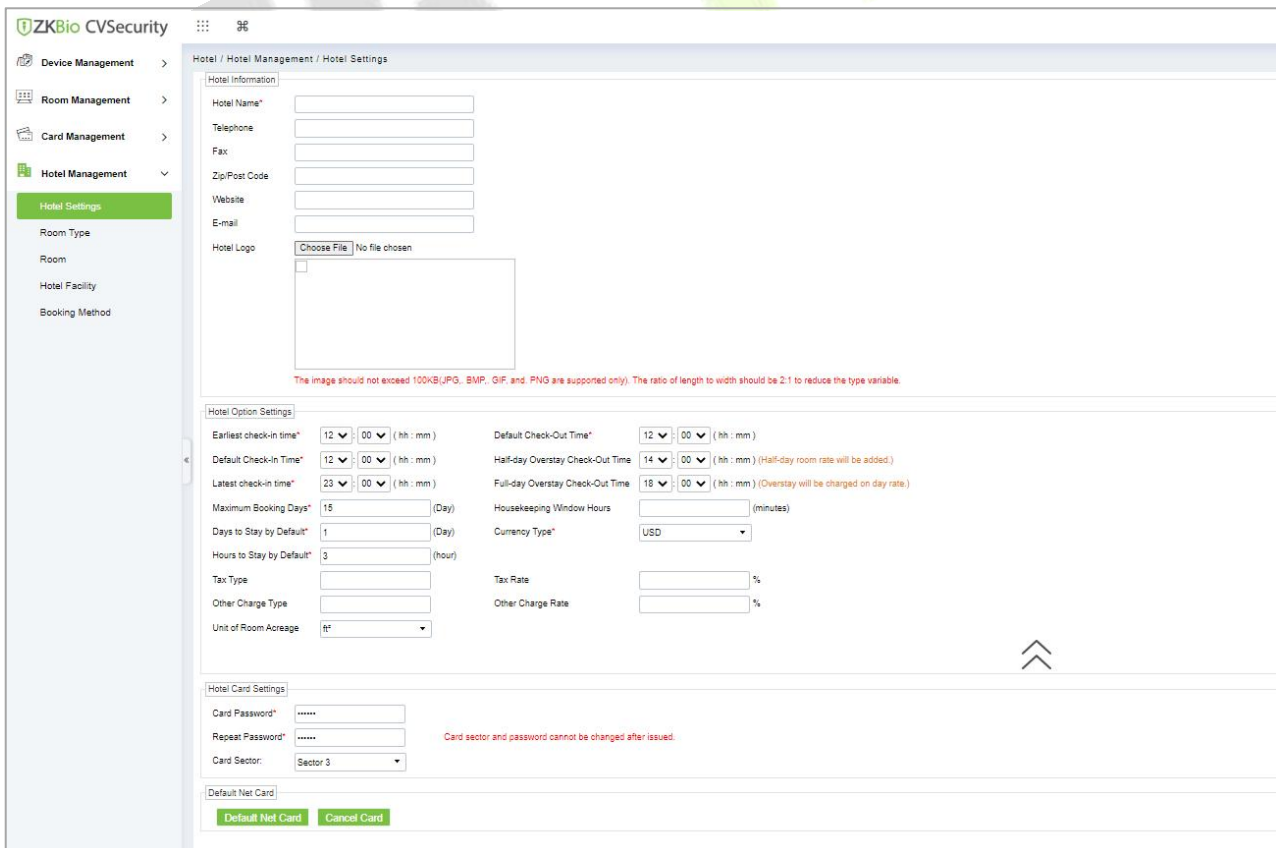

Figure 17-16 Hotel Setting

Parameter	Description
Default Check-In Time	You can set this time yourself. If a guest checks in before this time, the check-out date is the current day if the guest stays for one day. Otherwise, the check-out date is the next day.
Default Check-Out Time	It specifies the end time of a day use room
Overstay Check-Out Time 1/2	You can set this time yourself. If a guest checks out at a time between Overstay Check-Out Time 1 and Overstay Check-Out Time 2, the guest must pay an overstay charge. If a guest checks out at a time after Overstay Check-Out Time 2, the guest must pay for an extra day.
Reservation Date Range	It is the period for which the advance booking can be started.
Default Staying Days	It specifies the default number of days a guest stays. Generally, a guest stays for 1 day.
Default Staying Hours	It specifies the user-defined minimum number of hours a guest may stay. If a guest stays for a period less than this limit, the guest is charged the rate corresponding to this limit.
Elevator/Access Control	After selecting this check box, you can select an access/elevator control level on the card issuing UI, so that an issued card can be used not only as a hotel card, but also used to access the devices corresponding to the selected level. (>>Note: This check box is available on the Hotel Settings page only after you use the access control module and/or elevator control module and obtain and activate a license.)
Tax/Tax Rate:	You can mention the tax name and the percentage below.
Other Charges/Rate	It specifies any other kind of taxes, depending on the region.
Cleaning Time Limit:	It specifies the time available for cleaning a room after a guest checks out.
Checkout Remind:	It specifies whether to display a reminder one hour before checkout.
Currency Type	It specifies the currency.

Table 17-5 Parameter Hotel Setting

Note: The hotel management system can be used to define buildings, floors, and rooms as well as handle check-in requests only after you set these parameters.

17.4.2 Room Types

You can design information about various types of room, such as the number of beds and number of guests allowed. You can also enable and disable the vacant rooms.

Click **Room Management > Room Type > New**. The page shown in the following figure appears.

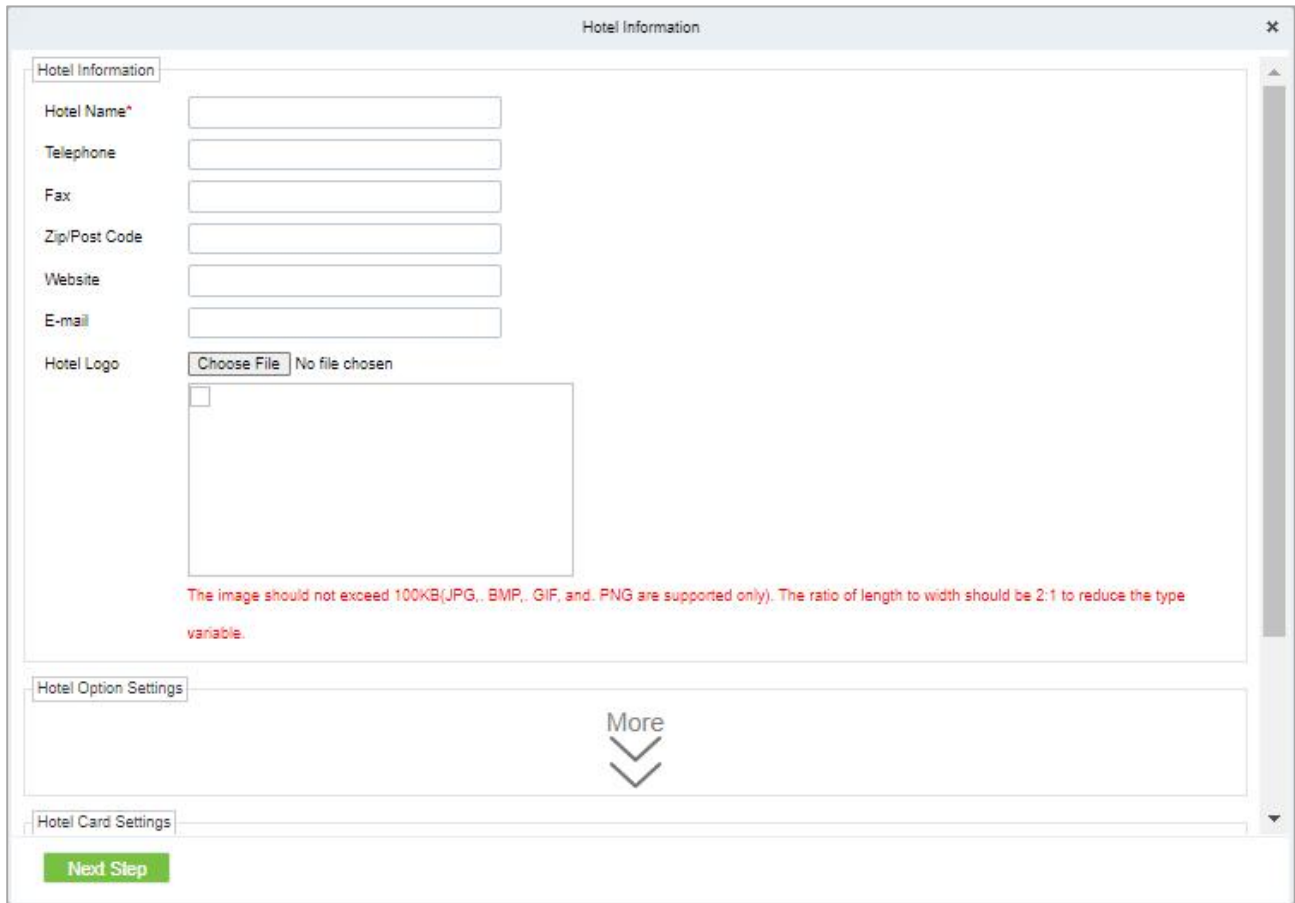

Figure 17-17 Room types

⚠️ Note: When you add a room type, the system checks whether hotel setting is configured. If no, you are redirected to the settings page. All room types must be unique.

17.4.2.1 Delete

Select room type, click **Delete**, and click **OK** to delete the room type.

17.4.2.2 Disable/Enable

Select room type, click **Disable/Enable** to stop/start using the room. The status of the room visible according with the enable or disable option.

17.4.3 Room

17.4.3.1 Adding Guest Rooms

Click **Room Management > Room > New**. The page shown in the following Figure17-18 appears.

Figure 17-18 Add Rooms

Select the desired Building, Floor and Room type.

Parameter	Description
Start Room Number	It specifies the start number of rooms
Room Count	It specifies the number of rooms to add. The value 1 indicates only one room is added. A value greater than 1 indicates that a batch of rooms is added
Remark	It describes about the room

Table 17-6 Parameter Room

Note: All room names must be unique.

17.4.3.2 Editing Guest Room

Select one guest room and edit the guest room. Duplication of guest room names are not allowed. Guest rooms that have been checked in or booked cannot be edited. See the following figure.

Figure 17-19 Edit Room

Editing Guest Rooms in Batches:

Select the check boxes of multiple guest rooms and edit them in batches. Duplication of guest room names is not allowed.

Only the rooms of the same type and belonging to the same building and same floor can be edited in batches. See the following figure.

The 'Edit' dialog box contains the following fields:

- Building No*: BZ
- Floor No*: 20CENG
- Room Type*: BZ
- Start Room Number*: 1
- Room Count*: 8
- Remark: (empty text area)

Room name generation rules: Building No. + Floor No. + Room Number

Buttons: OK, Cancel

Figure 17-20 Editing Guest Rooms in Batches

17.4.3.3 Deleting Building and Floor

Select one or more guest rooms and delete them.

Only the guest rooms that have not been checked in or booked can be deleted.

17.4.3.4 Exporting Guest Room Information

Export the data of the guest rooms that have not been checked in or booked.

17.4.4 Booking Methods

You can define methods for booking hotel rooms. During system installation, the basic booking methods are initialized by default and cannot be edited or deleted.

Booking method	Create Time	Last Updated Time	Operations
<input type="checkbox"/> ani	2022-08-02 08:48:08	2022-08-02 08:48:08	
<input type="checkbox"/> Online Booking	2022-07-27 08:09:34	2022-07-27 08:09:34	
<input type="checkbox"/> Booking by Phone	2022-07-27 08:09:34	2022-07-27 08:09:34	
<input type="checkbox"/> Booking by receptionist	2022-07-27 08:09:34	2022-07-27 08:09:34	

Figure 17-22 Booking Methods

Click **Hotel Management > Booking Method > New**. The page shown in the following figure 17-23 appears.



Figure 17-23 Add Booking Methods

Note: Duplication of booking method names is not allowed. Unused booking methods can be deleted.

17.4.4.1 Delete

In the **Hotel** interface, click **Hotel Management > Booking Method**, Select the booking method, click **Delete** under **Operations** or the **delete** button on the top of the list to delete the reservation. Click **OK** to confirm the delete operation.

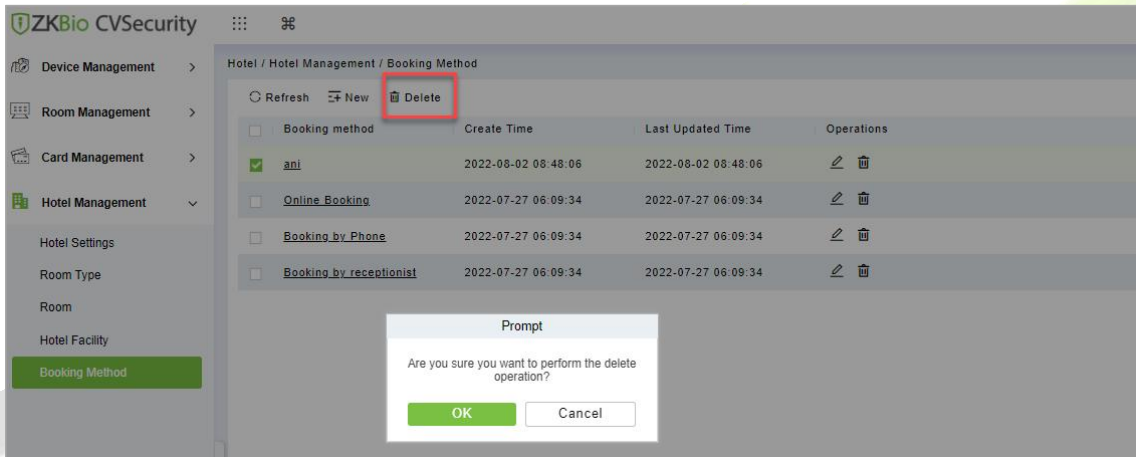

Figure17-24 Delete Booking Methode

17.4.5 Hotel Facility

In Hotel interface, Click **Hotel Management > Hotel Facility**. The page shown in the following figure 17-20 appears. It will show the Facilities of the hotel including the floor number, room name and room type.

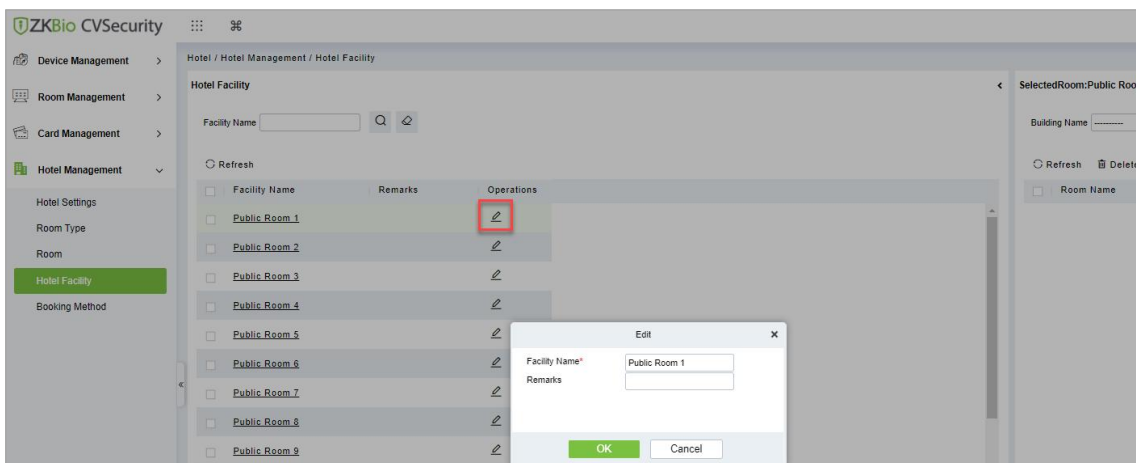

Figure 17-21 Editing Guest Rooms in Batches

17.5 Report Management

17.5.1 Guest Check-In Report

To view the guest check-in details report, enter the search conditions and view the records.

The screenshot shows a web interface for viewing guest check-in details. At the top, there are search filters for Building No., Floor No., and Room Name, along with a 'More' dropdown and search icons. Below the filters, it states 'The current query conditions: None'. There are buttons for 'Refresh', 'Export', and 'Delete'. The main area contains a table with the following columns: Guest Name, Document Type, Document No., Card Number, Check-In Time, Check-Out Time, Checkin Type, and Room Name. The table lists 9 records. At the bottom, there is a pagination bar showing '50 rows per page', 'Jump To 1 /1 Page', and 'Total of 9 records'.

Guest Name	Document Type	Document No.	Card Number	Check-In Time	Check-Out Time	Checkin Type	Room Name
2828	Passport	2131231	509171977	2017-05-11 10:12:18	2017-05-11 10:13:03	Daily Rate Room	SR21 F 13
12	Passport	geini1	1080423694	2017-05-12 09:54:46	2017-05-13 12:00:00	Daily Rate Room	SR21 F 5
13	Passport	geini1	1080423694	2017-05-12 09:49:17	2017-05-12 09:50:43	Daily Rate Room	BZ20CENG18
14	Passport	geini1	1080423694	2017-05-12 09:50:47	2017-05-12 09:53:33	Daily Rate Room	BZ20CENG19
15	Others	12341231	1080423694	2017-05-16 14:22:04	2017-05-16 14:22:23	Daily Rate Room	SR21 F 4
16	Passport	geini1	665212603	2017-05-12 09:59:26	2017-05-13 12:00:00	Daily Rate Room	SR21 F 6
12323	Others	12341231	1080423694	2017-05-16 14:16:33	2017-05-16 14:20:51	Daily Rate Room	SR21 F 4
1	Passport	tuandui	1080423694	2017-05-16 14:24:51	2017-05-18 12:00:00	Daily Rate Room	SR21 F 15
12323	Others	12341231	1080423694	2017-05-16 14:22:23	2017-05-17 12:00:00	Daily Rate Room	SR21 F 6

Figure 17-25 Guest Check-in

You can export the records into an Excel, PDF, or CSV file. See the following figure.

ZKTECO
Guest Checkin Report

First Name	Last Name	Document Type	Document No.	Card Number	Check-In Time	Check-Out Time	Checkin Type	Room Name	Room Type
Maryan	Liu	ID	44443333	4117649102	2017-12-15 14:42:09	2017-12-15 15:18:49	Daily Rate Room	A1101	A
Carian	Xie	Passport	332454	4117858142	2017-12-15 14:51:15	2017-12-15 15:14:20	Daily Rate Room	B1103	A
Lucy	Feng	Passport	232145523	301973533	2017-12-15 14:43:39	2017-12-15 15:13:52	Daily Rate Room	A1102	A
Lucy	Feng	Passport	232145523	301973533	2017-12-15 15:13:52	2017-12-15 15:19:06	Daily Rate Room	B1105	A
Hook		ID	5577556	4117882494	2017-12-15 14:45:37	2017-12-15 14:50:09	Daily Rate Room	B1102	A
Maryan	Liu	ID	44443333	4117649102	2017-12-15 14:42:09	2017-12-15 15:18:49	Daily Rate Room	A1101	A
Bruno	Ke	Driver License	22322123	4117882494	2017-12-15 14:51:15	2017-12-15 15:14:20	Daily Rate Room	B1103	A

Figure 17-26 Export Guest Check-in

17.5.2 Room Occupancy Report

To check the room occupancy information (including the room name, type, check-in type, check-in time, and check-out time), enter the search conditions and view the records. You can export the records into an Excel, PDF, or CSV file. See the following figure.

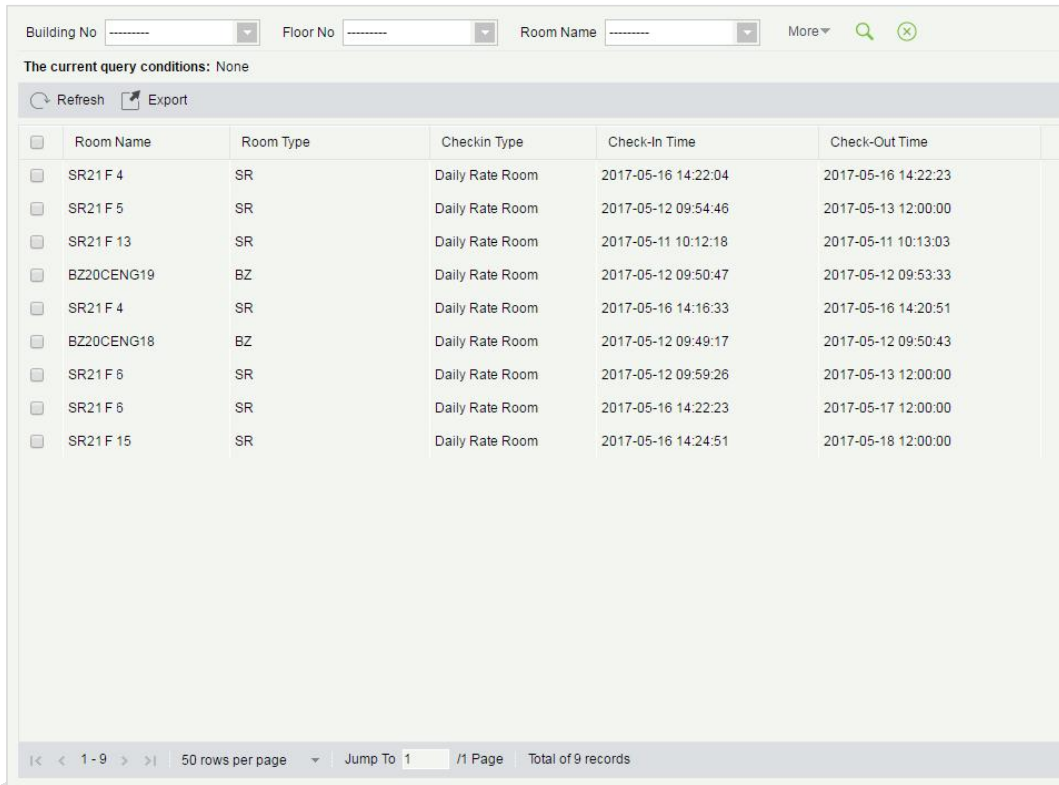

Figure 17-27 Room Occupancy Report

You can export the records into an Excel, PDF, or CSV file. See the following figure 17-26.

ZKTECO Room Checkin Report				
Room Name	Room Type	Checkin Type	Check-In Time	Check-Out Time
A1102	A	Daily Rate Room	2017-12-15 14:43:39	2017-12-15 15:13:52
A1101	A	Daily Rate Room	2017-12-15 14:42:09	2017-12-15 15:18:49
B1102	A	Daily Rate Room	2017-12-15 14:45:37	2017-12-15 14:50:09
B1103	A	Daily Rate Room	2017-12-15 14:51:15	2017-12-15 15:14:20
B1105	A	Daily Rate Room	2017-12-15 15:13:52	2017-12-15 15:19:06

Figure 17-28 Export Room Occupancy report

17.5.3 Room Charges Report

To check the room expenses record, enter the search conditions (including time, guest name, room name, and room type) and view the records. See the following figure 17-29.

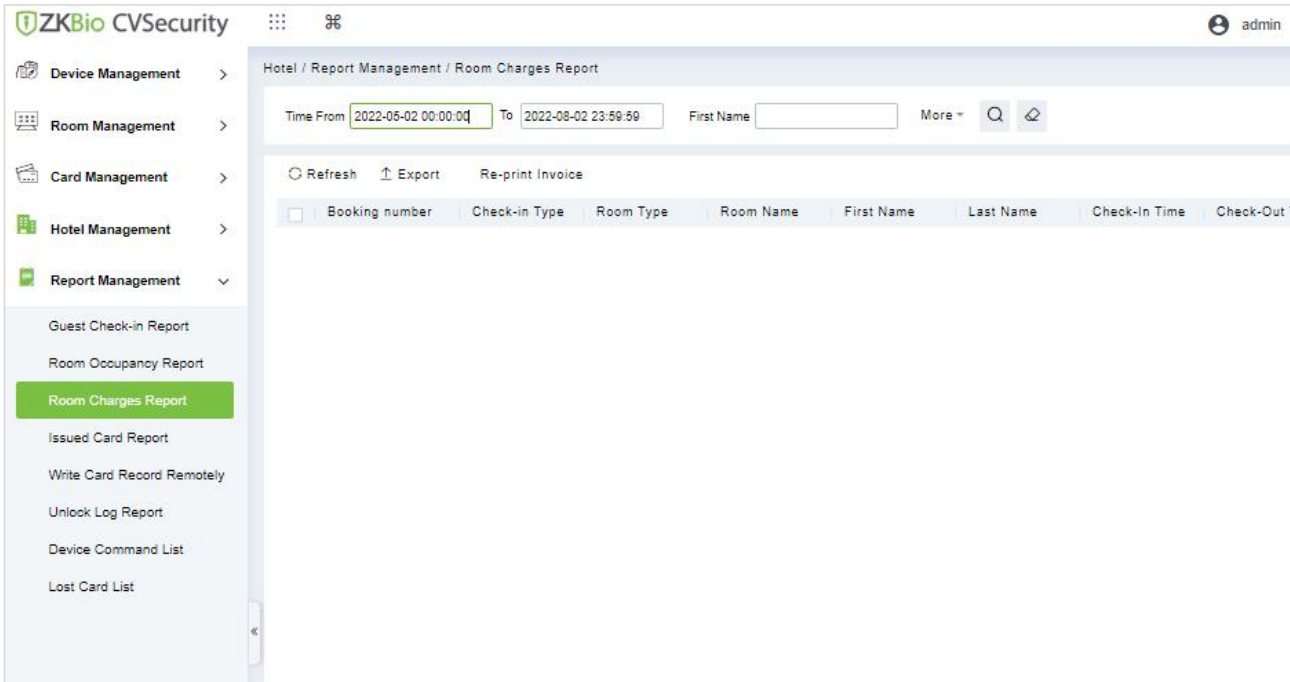

Figure 17-29 Room Charges Report

Re-Print Invoice:

The old receipt number is cancelled, and a new receipt is created with a new receipt number. A customer who lost their receipt has requested a duplicate receipt with their original receipt number.

17.5.4 Issue Card Report

You can also view all card writing records or search required card writing records with multiple search conditions. Enter the search conditions (including time, card type, card No., issuing date, and expiration date) and check the associated card writing records.

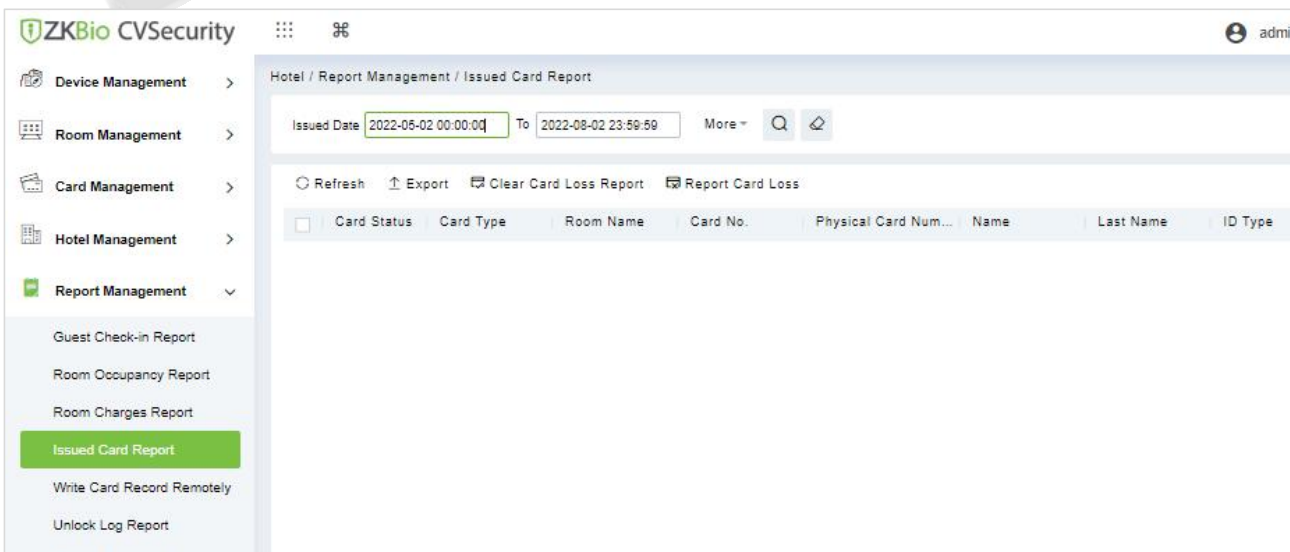

Figure 17-30 Issue Card Report

You can export the records into an Excel, PDF, or CSV file. See the following figure.

ZKTECO Issue Card Report										
First Name	Last Name	Card Type	Card Number	Document Type	Document No.	Issued Date	Expiration Date	Card Status	Issue Time	Operation User
Sherry	Yang	Room Name Card	21			2017-12-15 15:28:51	2017-12-15 15:31:13	Invalid card	2017-12-15 15:28:51	admin
Sherry	Yang	Room Area Card	20			2017-12-15 15:25:57	2017-12-15 15:31:08	Invalid card	2017-12-15 15:25:57	admin
Lucy	Feng	Guest Card	19	Passport	232145523	2017-12-15 15:13:54	2017-12-15 15:19:03	Invalid card	2017-12-15 15:13:54	admin
Maryan	Liu	Guest Card	18	ID	44443333	2017-12-15 15:13:26	2017-12-15 15:18:44	Invalid card	2017-12-15 15:13:26	admin
Sherry	Yang	Authorization Card	17			2017-12-15 15:08:48	2017-12-15 15:25:38	Invalid card	2017-12-15 15:08:48	admin
Sherry	Yang	Room Name Card	16			2017-12-15 15:08:24	2017-12-15 15:31:18	Invalid card	2017-12-15 15:08:24	admin
Sherry	Yang	Room Name Card	15			2017-12-15 15:07:14	2017-12-15 15:31:43	Invalid card	2017-12-15 15:07:14	admin
Sherry	Yang	Room Name Card	14			2017-12-15 15:06:21	2017-12-15 15:06:34	Invalid card	2017-12-15 15:06:21	admin
Sherry	Yang	Floor Card	13			2017-12-15 15:05:35	2017-12-15 15:07:48	Invalid card	2017-12-15 15:05:35	admin
Sherry	Yang	Building Card	12			2017-12-15 15:04:37	2017-12-15 15:08:37	Invalid card	2017-12-15 15:04:37	admin
Carlan	Xie	Guest Card	11	Passport	332454	2017-12-15 14:55:55	2017-12-15 15:02:50	Invalid card	2017-12-15 14:55:55	admin
Bruno	Ke	Guest Card	10	Driver License	22322123	2017-12-15 14:54:17	2017-12-15 15:14:14	Invalid card	2017-12-15 14:54:17	admin
Hook		Guest Card	9	ID	5577556	2017-12-15 14:47:30	2017-12-15 14:50:02	Invalid card	2017-12-15 14:47:30	admin
Lucy	Feng	Guest Card	8	Passport	232145523	2017-12-15 14:44:44	2017-12-15 15:13:54	Invalid card	2017-12-15 14:44:44	admin
Maryan	Liu	Guest Card	7	ID	44443333	2017-12-15 14:42:57	2017-12-15 15:13:26	Invalid card	2017-12-15 14:42:57	admin
Sherry	Yang	Room Name Card	6			2017-12-15 14:41:00	2017-12-15 14:41:50	Invalid card	2017-12-15 14:41:00	admin
Sherry	Yang	Room Name Card	5			2017-12-15 14:40:32	2017-12-15 15:04:13	Invalid card	2017-12-15 14:40:32	admin
Sherry	Yang	Room Name Card	4			2017-12-15 14:39:48	2017-12-15 14:40:18	Invalid card	2017-12-15 14:39:48	admin

Created on: 2017-12-15 18:44:22
Created from ZKBioSecurity software. All rights reserved. 1/2

Figure 17-31 Export Issue Card Report

Clear Card Loss Report:

Clear all the details of the loss card reports.

Report Card Loss:

A report loss card is a card that is invalidated and obsolete (usually due to loss or damage of the card) during its validity period.

17.5.5 Write Card Record Remotly

You can read a record card to check the lock opening record. Place the record card on a write card remotely. You can export the records into an Excel, PDF, or CSV file. See the following figure.

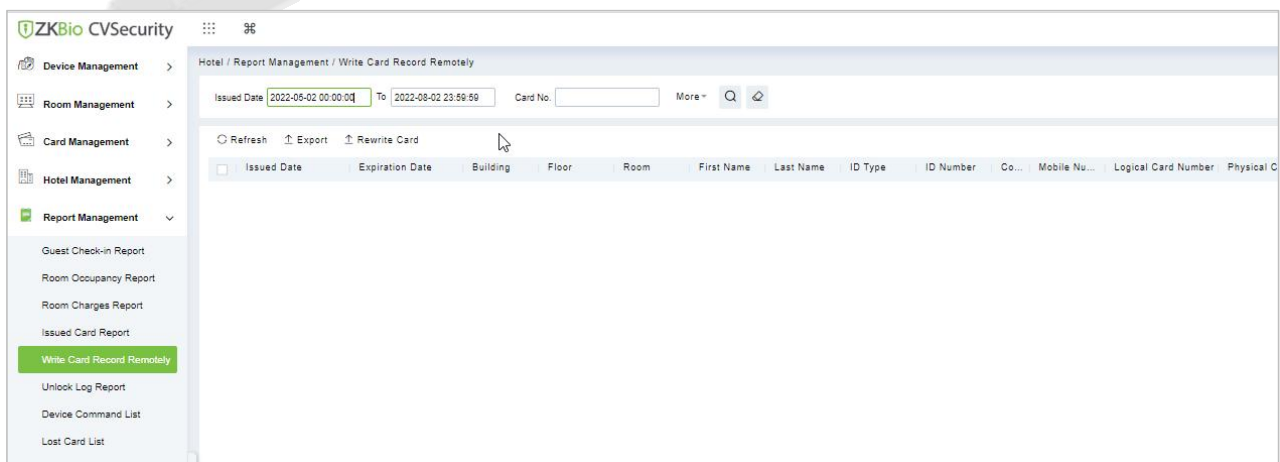

Figure 17-32 Write Card Remotly Export

Rewrite Card:

In **Hotel** interface, click **Report Management > Write Card Record Remotly**. You can rewrite the same card with the correct information if you wrote any incorrect information on it.

17.5.6 Unlock Log Report

You can read a record card to check the lock opening record. Place the record card on a card writer and click Read Lock Opening Record to obtain all lock opening records of the record card. You can enter search conditions (including the building/floor/room name, start time, and end time) and view the associated records. You can export the records into an Excel, PDF, or CSV file.

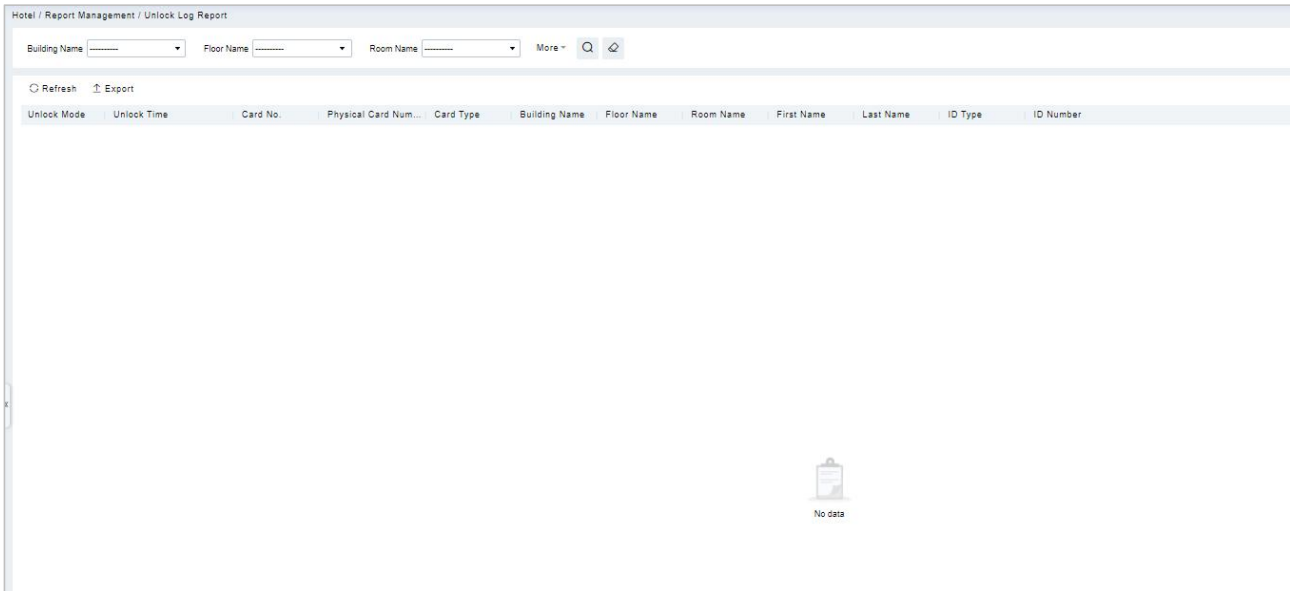

Figure 17-33 Unlock Log report

17.5.7 Device Command List

You can also view all device logs records in the device command list.

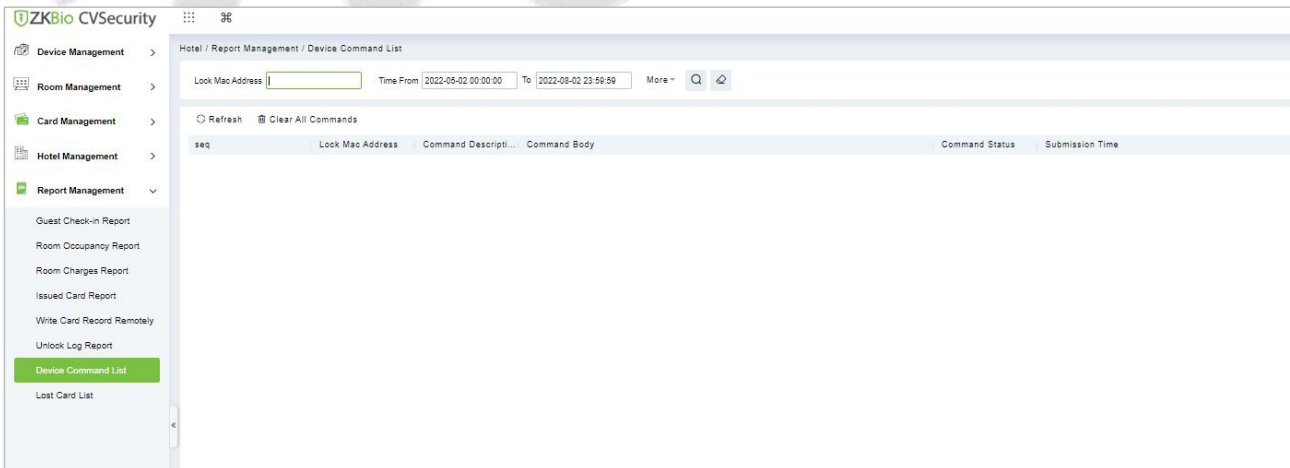

Figure 17-34 Device Commands List

You can clear command as required. Click **Clear Command** behind the corresponding device.

17.5.8 Lost Card List

You can also view all lost card details in the lost card list.

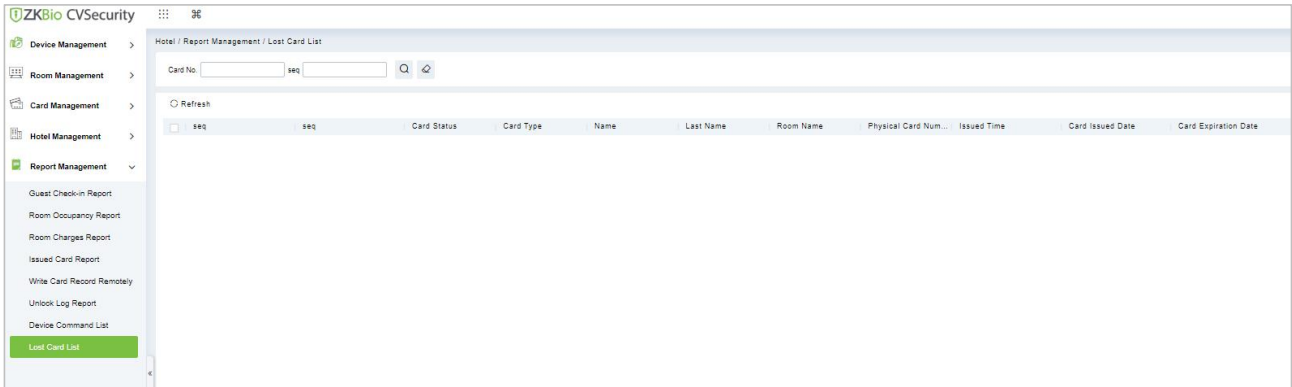

Figure 17-35 Lost Card List



18 Intrusion

Intrusion systems are mainly applied to places where people cannot control in real time such as dangerous areas that require boundary control. For example, if an intruder is found in a restricted area, corresponding alarms will be generated, essentially to ensure the area's safety.

Keywords	Description
Partition	A partition consists of multiple zones.
Zone	To manage and control sensors. The sensors are assigned to zones and when a sensor is triggered, the system informs user which zone a sensor has been triggered.
Bypass	Points that are Service Bypassed cannot produce Extra Point events
Unbypass	Points that are Service Bypassed can produce Extra Point events.

Table 18- 1 Key Words Description

18.1 Intrusion Device

Device mainly includes the Device docking, Device host docking, Synchronize Data and Time, as well as some invasion of some defense areas and partition configuration.

18.1.1 Device

18.1.1.1 Add devices (New)

Step 1: Go to **Intrusion > Intrusion Device > Device**.

Step 2: Click **New**, and the interface for adding a device will pop up.

Step 3: In the interface for adding a device, fill in the corresponding parameters according to the adding requirement, as shown in the Figure 18-1. Please refer to Table 18-2 for the description of parameter.

Figure 18- 1 Adding Device Interface

Parameter	Description
Manufacturer	The brand of the alarm host.
Model	Device model of alarm host.
Device Name	Customize the name of the device.
IP Address	Fill in the IP address of the device.
Port	Divide the area for the device.
RPS Passcode	Password for communication (Please configure in Bosch A-link software in advanced and Risco doesn't need that).
Remarks	Text notes of the alarm host.

Table 18- 2 Adding Device Parameters

18.1.1.2 Delete

Step 1: Go to Intrusion > Intrusion Device > Device.

Step 2: Select device, click Delete, and the interface of Security Verification will pop up.

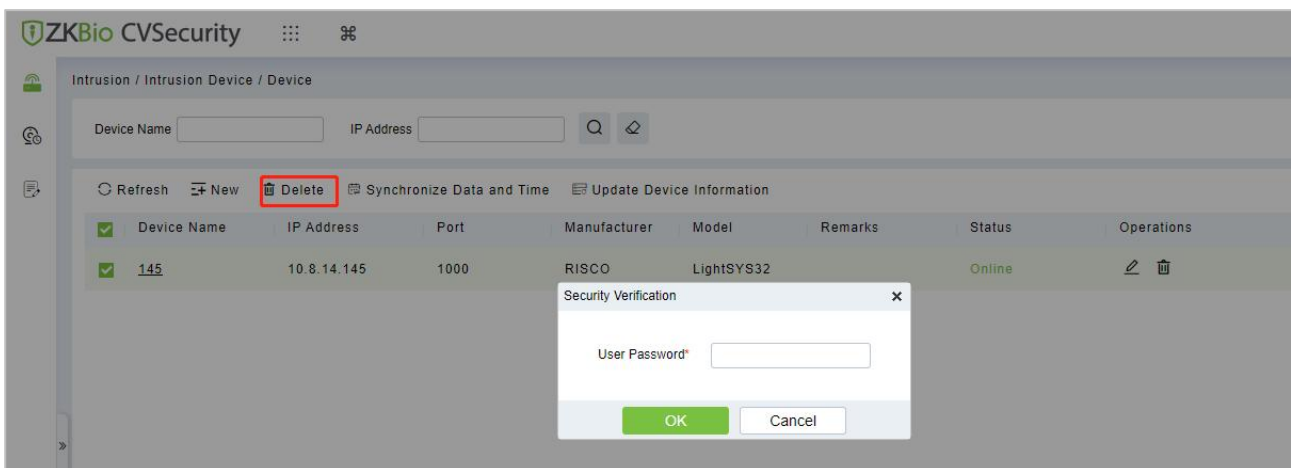

Figure 18- 2 Security Verification

Step 3: Fill the User Password, then click **OK**.

18.1.1.3 Synchronize Data and Time

Step 1: Go to **Intrusion > Intrusion Device > Device**.

Step 2: Select device, click **Synchronize Date and Time** and **Synchronize** to complete synchronization.

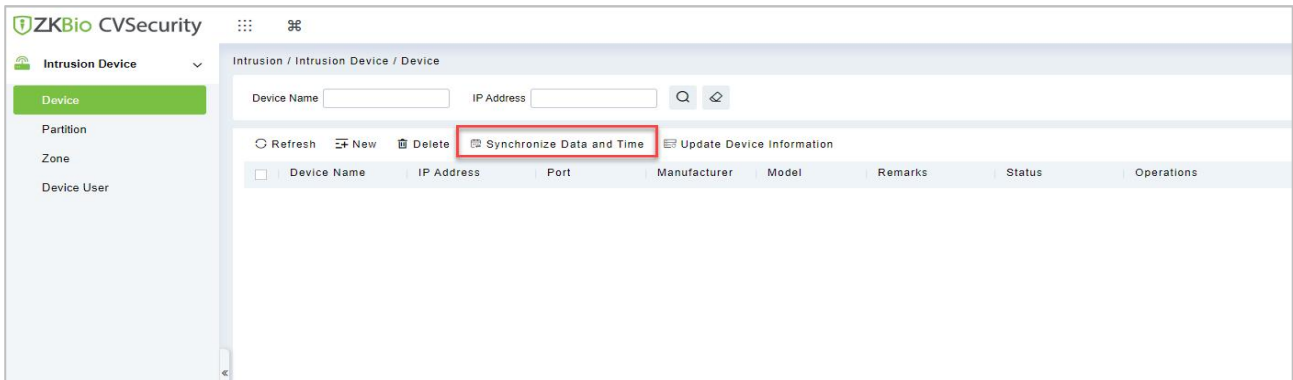

Figure 18- 3 Update Device Information

18.1.1.4 Update Device Information

Step 1: Go to **Intrusion > Intrusion Device > Device**.

Step 2: Select device, click **Update Device Information**, and the interface for Update Device Information will pop up. As shown in the Figure 18-4.

Step 3: Select the device information you want to get, and then click **Start**.

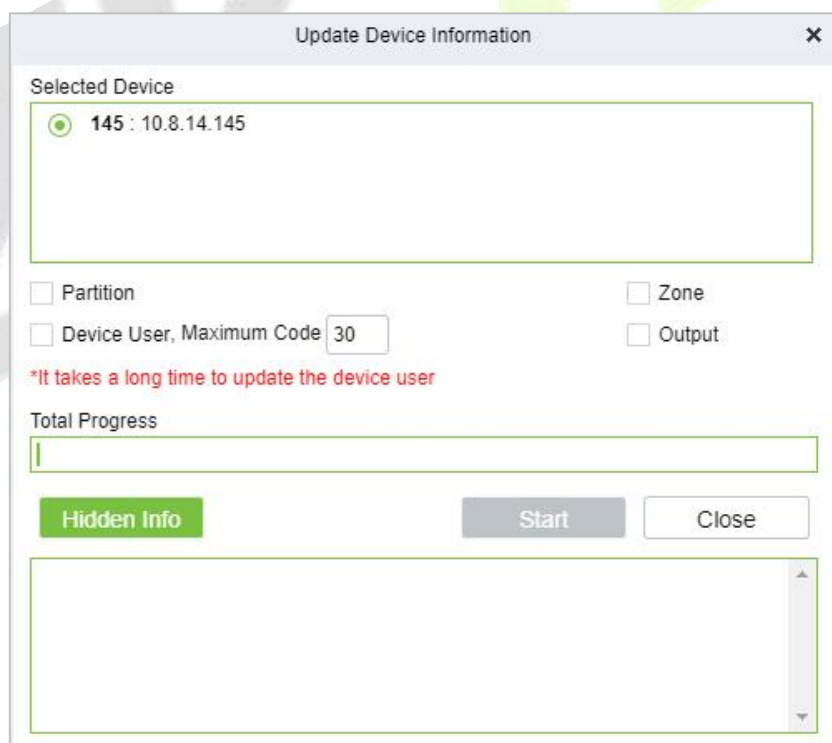

Figure 18- 4 Update Device Information

18.1.1.5 Edit

Step 1: Go to **Intrusion > Intrusion Device > Device**.

Step 2: Click icon  , fill the Device Name or Remarks, then click **OK**.

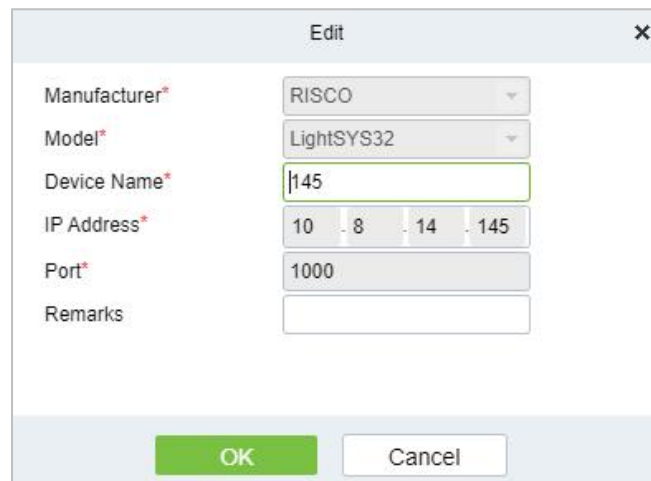



Figure 18- 5 Edit

18.1.2 Partition

18.1.2.1 Edit

Step 1: Go to **Intrusion > Intrusion Device > Partition.**

Step 2: Click icon  , select Area Name or fill Remarks, then click **OK.**

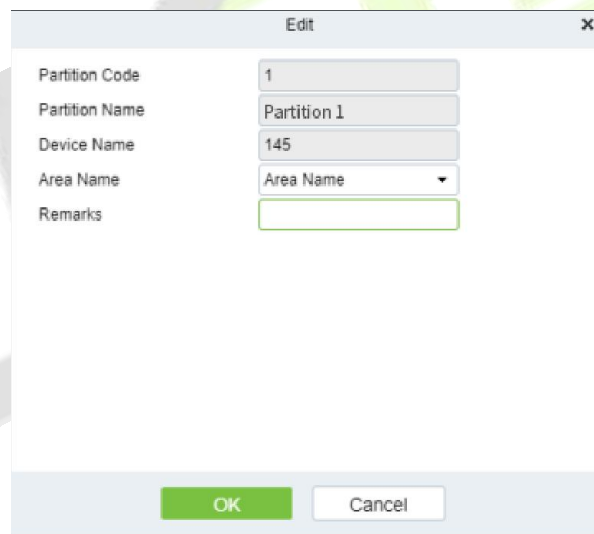

Figure 18- 6 Edit

18.1.2.2 Defense Deployment

Step 1: Go to **Intrusion > Intrusion Device > Partition.**

Step 2: Click icon  , fill user Password, then click **OK.**

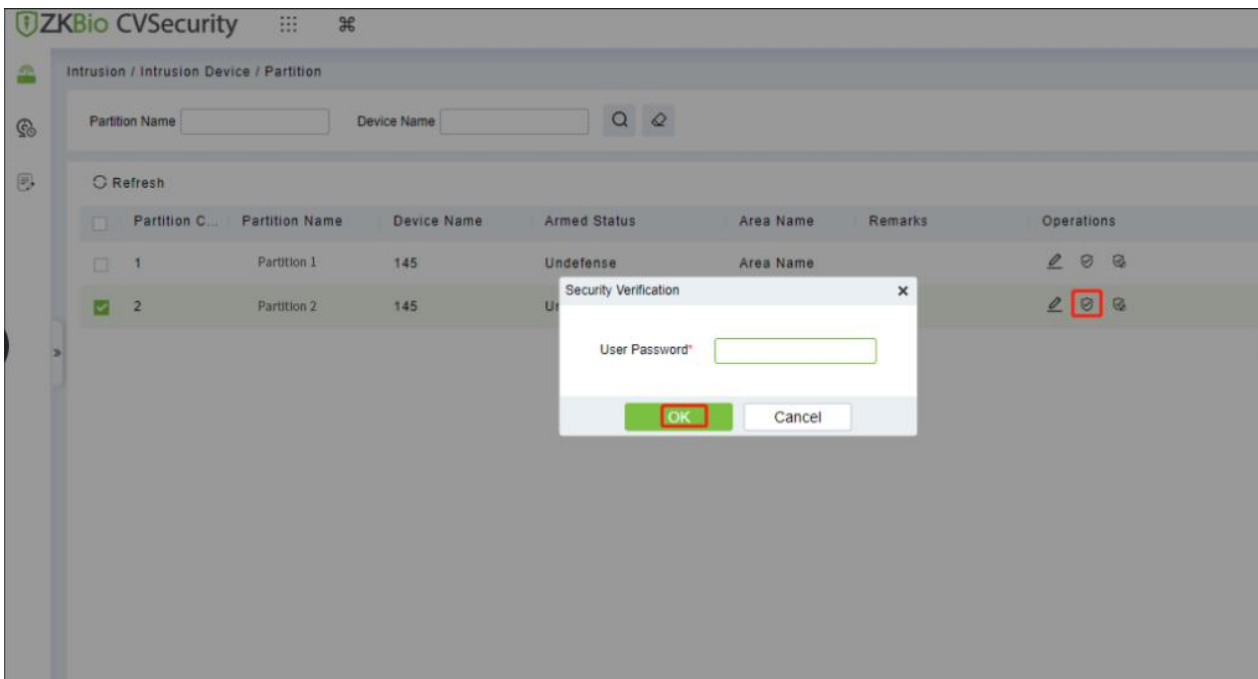

Figure 18- 7 Defense Deployment

18.1.2.3 Disarm

Step 1: Go to **Intrusion > Intrusion Device > Partition**

Step 2: Click icon , fill the User Password, then click **OK**.

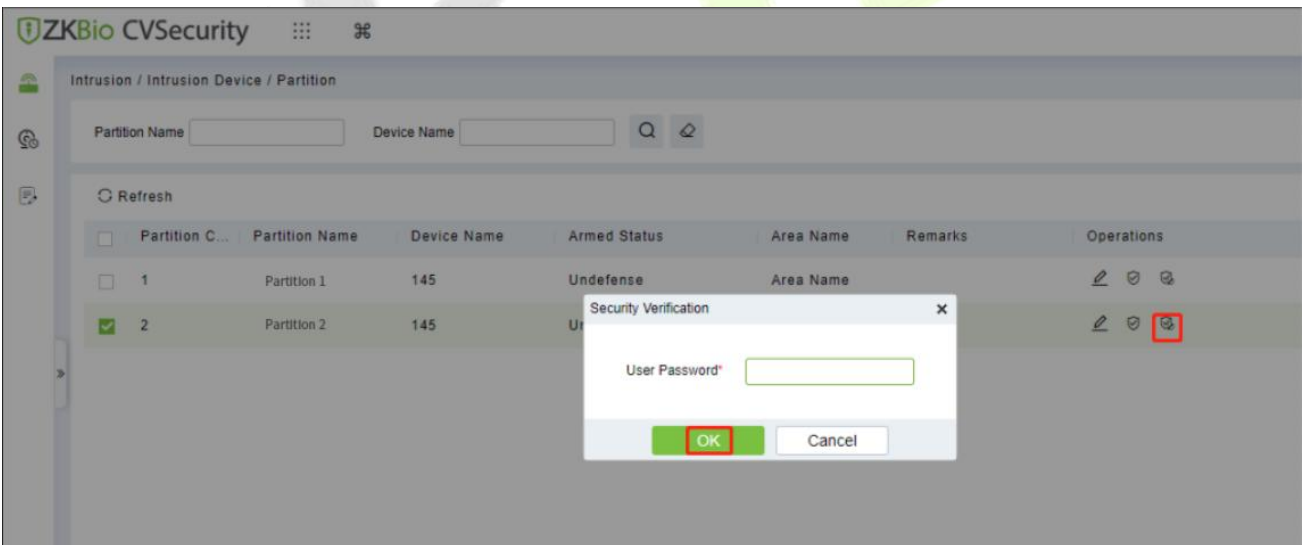

Figure 18- 8 Disarm

18.1.3 Zone

18.1.3.1 Edit

Step 1: Go to **Intrusion > Intrusion Device > Zone.**

Step 2: Click icon  , fill Remarks, then click **OK.**

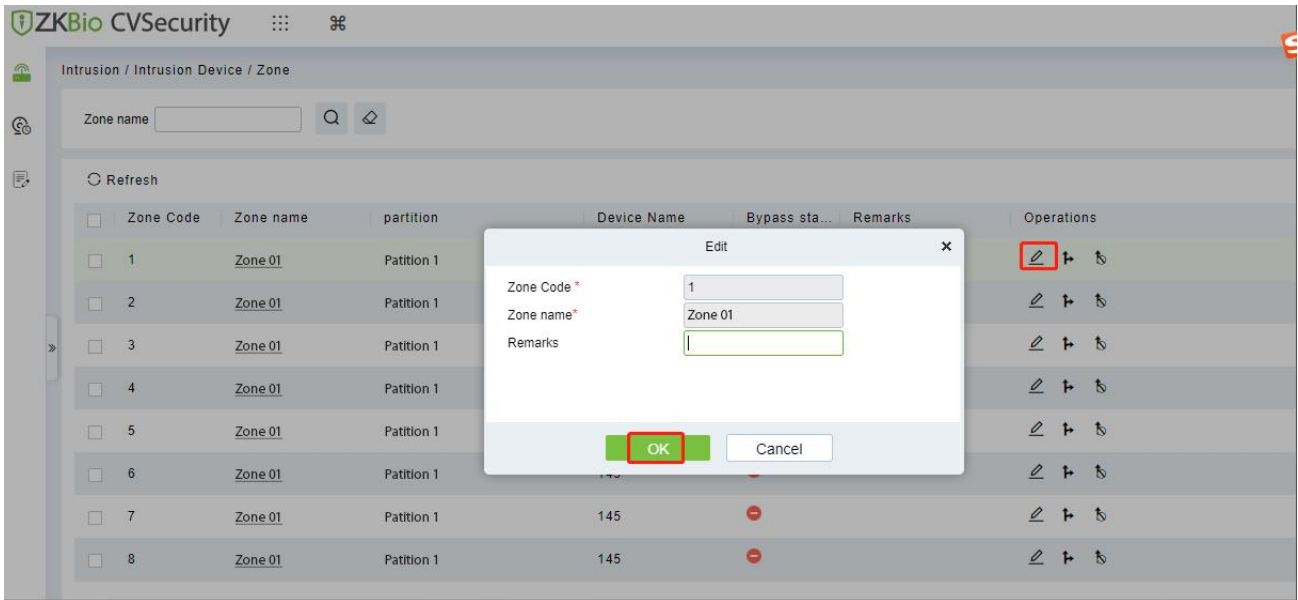

Figure 18- 9 Edit Zone

18.1.3.2 Bypass

Step 1: Go to **Intrusion > Intrusion Device > Partition.**

Step 2: Click icon  , then click **OK.**

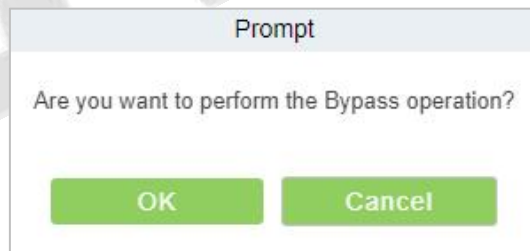

Figure 18- 10 Bypass

18.1.3.3 Cancel Bypass

Step 1: Go to **Intrusion > Intrusion Device > Partition.**

Step 2: Click icon  , then click **OK.**



Figure 18- 11 Cancel Bypass

18.1.4 Device User

18.1.4.1 New

Step 1: Go to **Intrusion > Intrusion Device > Device User**.

Step 2: Click **New**, and the interface for adding a device will pop up.

Step 3: In the interface for adding a device, fill in the corresponding parameters according to the adding requirement, as shown in the Figure 18-12. Please refer to Table 18-3 for the description of parameter.

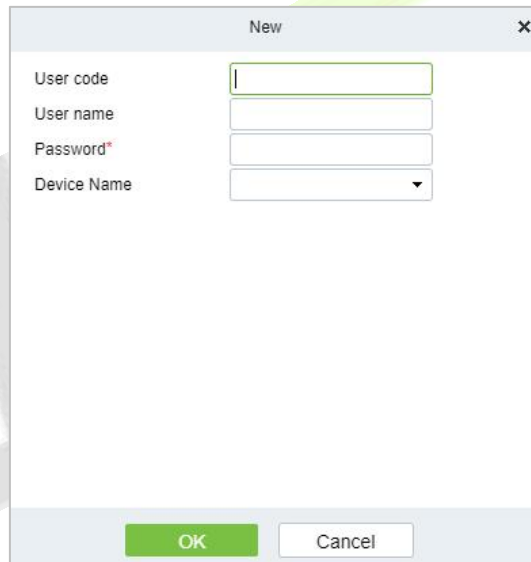

Figure 18- 12 Add Device User

Parameter	Description
User Code	You can customize the user’s unique code.
User Name	You can customize the user’s name.
Password	You can customize the user’s password used for logging in alarm host.
Device Name	Customize the name of the device.

Table 18- 3 Adding User Parameters

18.1.4.2 Update Device User

Step 1: Go to **Intrusion > Intrusion Device > Device User**.

Step 2: Click **Update Device User** with the mouse, and the interface of Update Device User will pop up.

Step 3: In the interface of **Update Device User**, fill in the corresponding parameters according to the

need for updates, as shown in the Figure 18-12. Please refer to Table3 for the description of parameter filling.

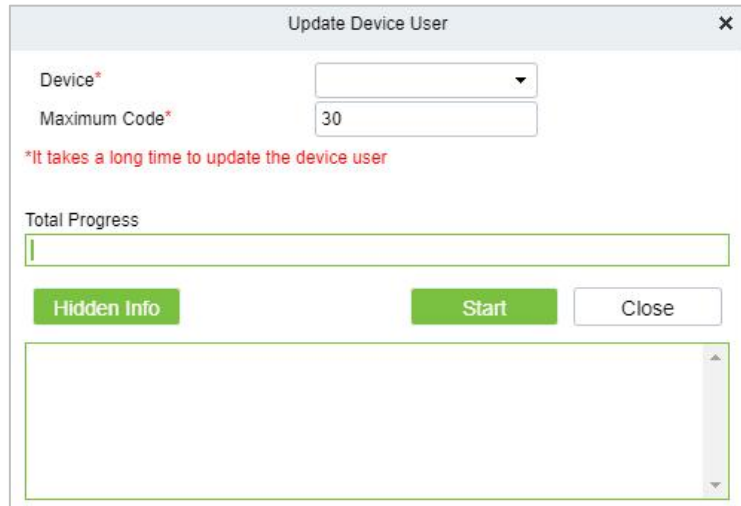

Figure 18- 13 Update Device User

Parameter	Description
Device	Select the alarm host that has been added.
Maximum Code	Define the maximum code for the alarm host to upload users.

Table 18- 4 Update Device User

18.1.4.3 Delete

Step 1: Go to **Intrusion > Intrusion Device > Device User**.

Step 2: Select device, click **Delete** or **Delete** option under **Operations**, and the interface of Security Verification will pop up. As shown in the figure 18-14.

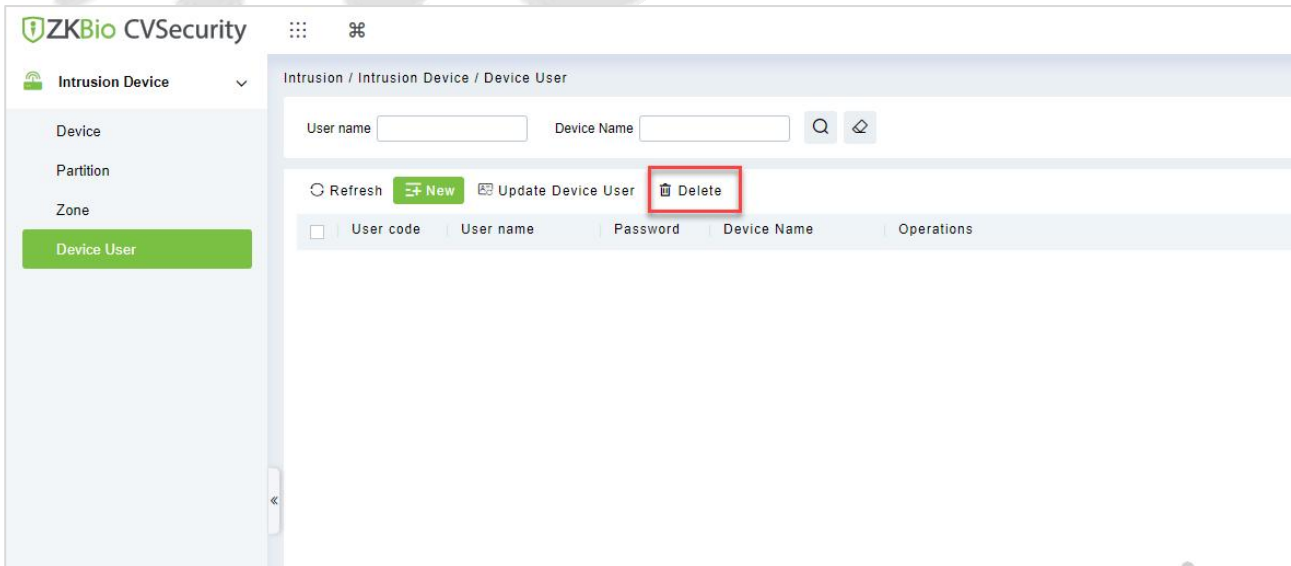



Figure 18- 14 Security Verification

Step 3: Fill the User Password, then click **OK**.

18.1.4.4 Edit

Step 1: Go to **Intrusion > Intrusion Device > Device User**.

Step 2: Click icon , modify the user name or password, then click **OK**.

18.2 Real-Time Monitoring

Real-Time Monitoring:

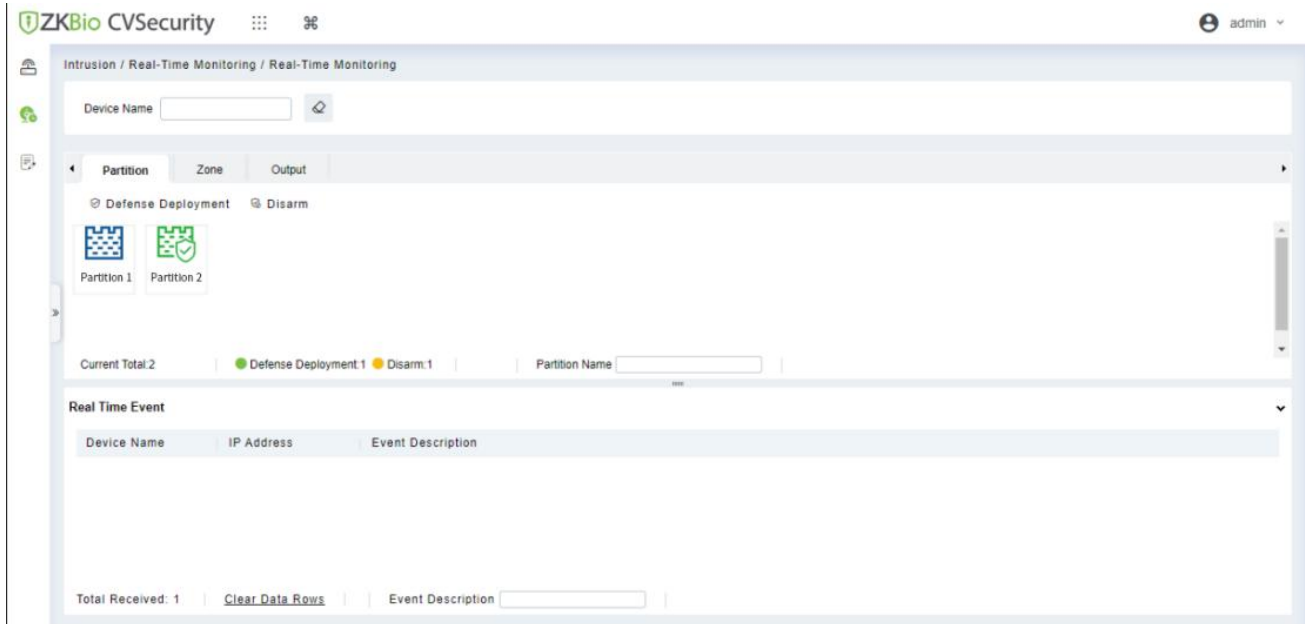

Figure 18- 15 Real-time Monitoring

Partition:

We can view the device status by placing the mouse cursor on the device. The green indicates the partition is Armed, and the Blue indicates the partition is not armed. We can also select the partition and operate it quickly, such as **Arm Partition, Disarm Partition**.



Figure 18- 16 Real-time Monitoring - Partition

Zone:

We can view the **Zone** status. The green indicates the Zone is on Cancel Bypass, the yellow indicates the Zone is on Bypass. We can also click on the Zone and operate it quickly, such as **Bypass, Cancel Bypass**.

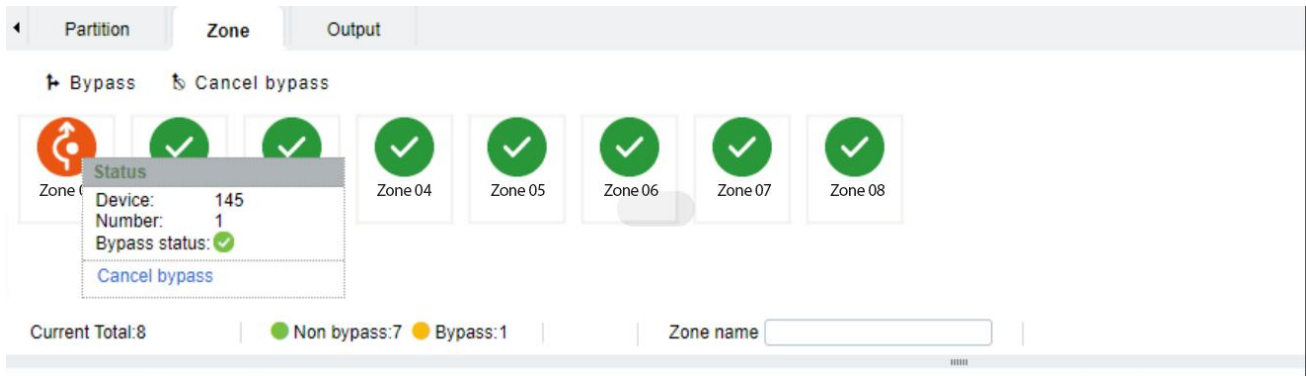

Figure 18- 17 Real-time Monitoring - Zone

Output:

We can view the status of Alarm Host’s Outputs. We can also click on the point and operate it quickly, such as Activate Output and Deactivate Output.

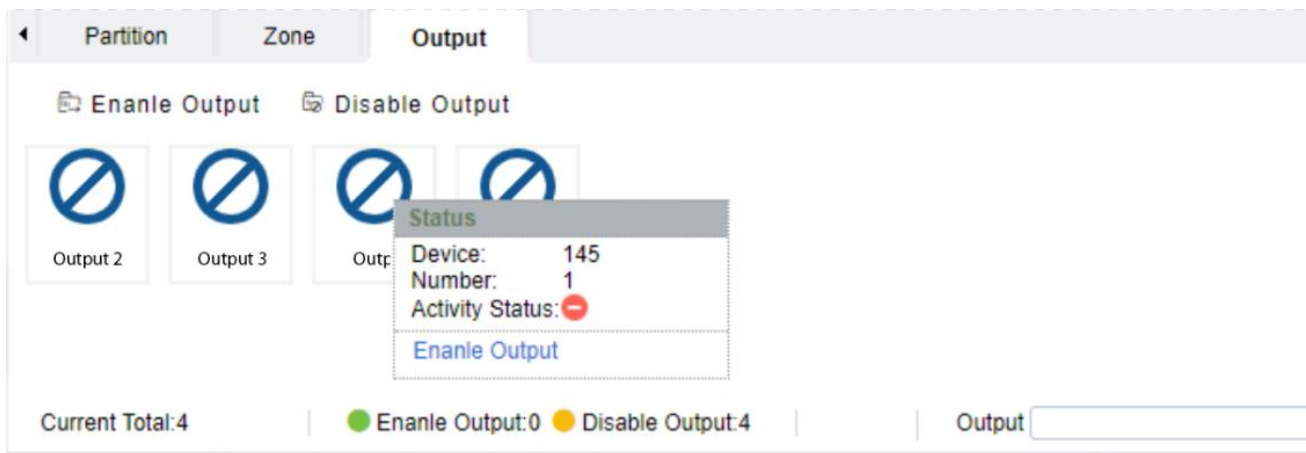

Figure 18- 18 Real-time Monitoring - Output

18.3 Intrusion Record

Event Record:

Step 1: Go to **Intrusion > Intrusion Record > Even Record.**

Step 2: On the Event Record interface, click **Export**, enter the admin password in the displayed security verification dialog box, and click **OK**. Select whether to encrypt the file and the file format to export, and click **OK**.

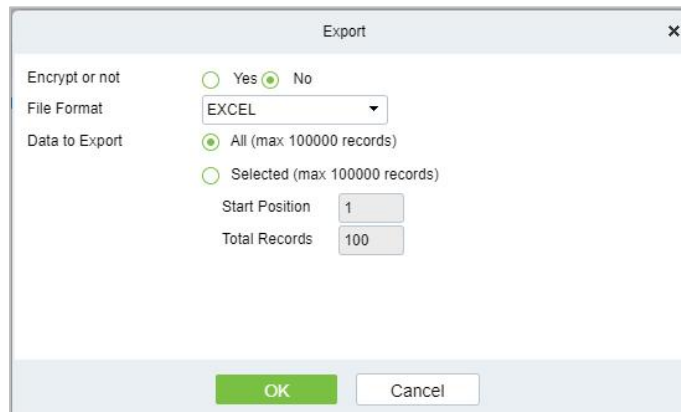

Figure 18- 19 Record Export Page

Clear All Data:

Click **Clear All Data** to pop up prompt and click **OK** to clear all transactions.

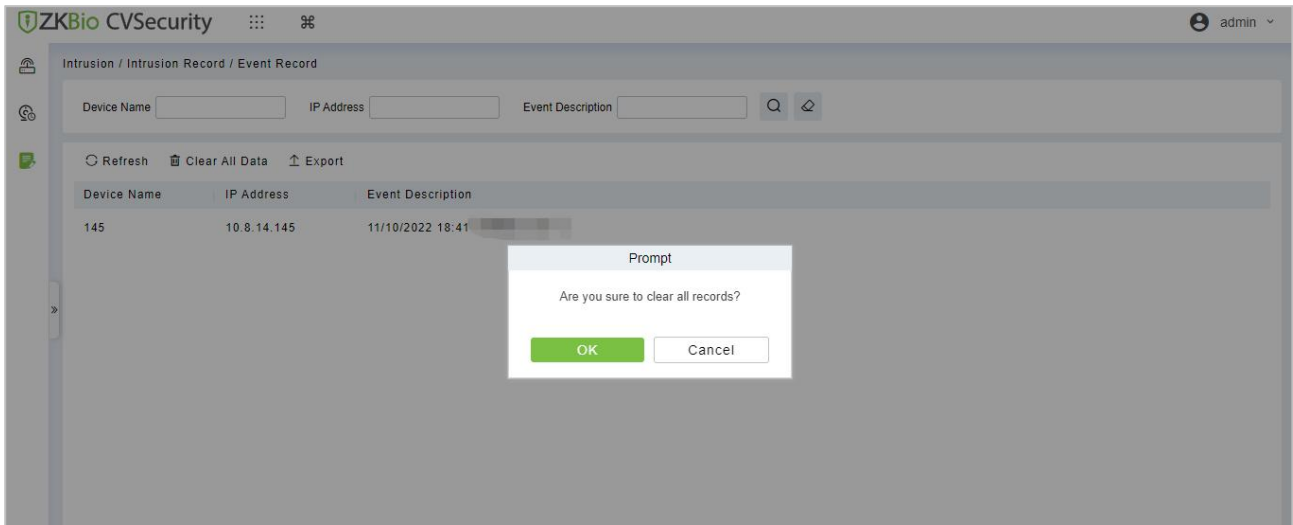

Figure 18- 20 Clear All Data

19 Locker

19.1 Locker Device Management

19.1.1 Device

19.1.1.1 Add Devices (New)

Step 1: Go to **Locker > Locker Device Management > Device**.

Step 2: Click **+New**, the interface for adding a device will pop up.

Step 3: In the interface for adding a device, fill in the corresponding parameters according to the adding requirement, as shown in the Figure 19-1. Please refer to Table 19-1 for the description of parameter.

Figure 19- 1 Adding Device Interface

Parameter	Description
Device Name	Customize the name of the device.
IP Address	Fill in the IP address of the device.
Serial Number	Fill the device serial number.
Communication Password	Fill in the communication password of the device. You can add it only after the verification is successful.
Area Name	Divide the area for the device.

Table 19- 1 Adding Device Parameters

19.1.1.2 Delete

Step 1: Go to **Locker > Locker Device Management > Device.**

Step 2: Select device, click **Delete**, then click **OK** to delete device.



Figure 19- 2 Delete Device

19.1.1.3 Control

Set Administrator:

Administration has permission to set the administrator permission to device. Select the person, click **>**, and click **OK**.

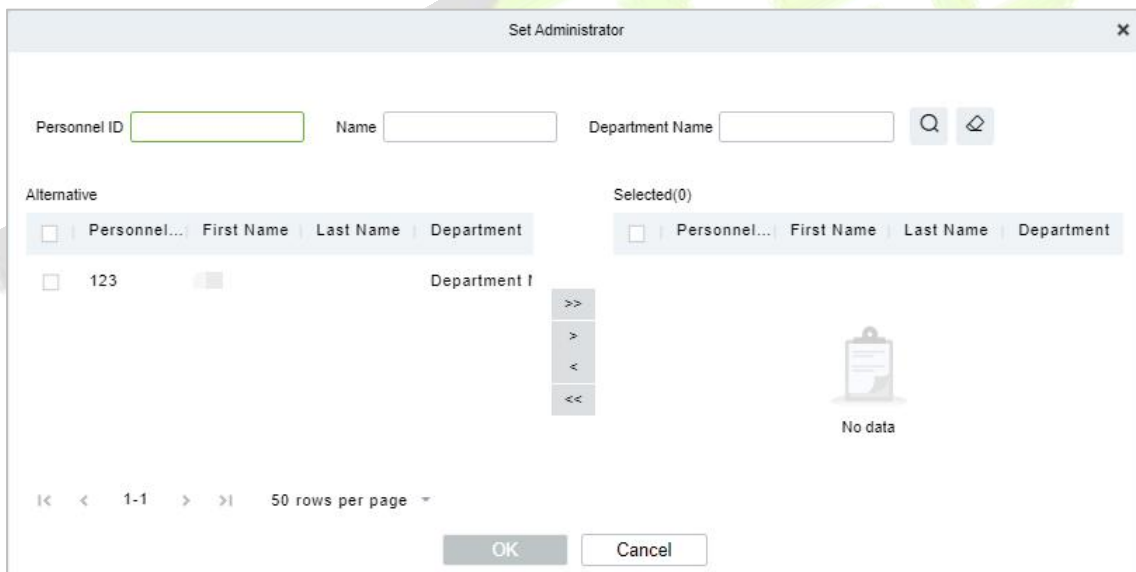

Figure 19- 3 Set Administrator Interface

Clear Administrator:

Administration has permission to clear the administration permission from device.

Reboot Device:

It will reboot the selected device.

Synchronize Time:

It will synchronize device time with server's current time.

Synchronize All Data to Devices:

Synchronize data of the system to the device. Select device, click **Synchronize All Data to Devices** and click **Synchronize** to complete synchronization.

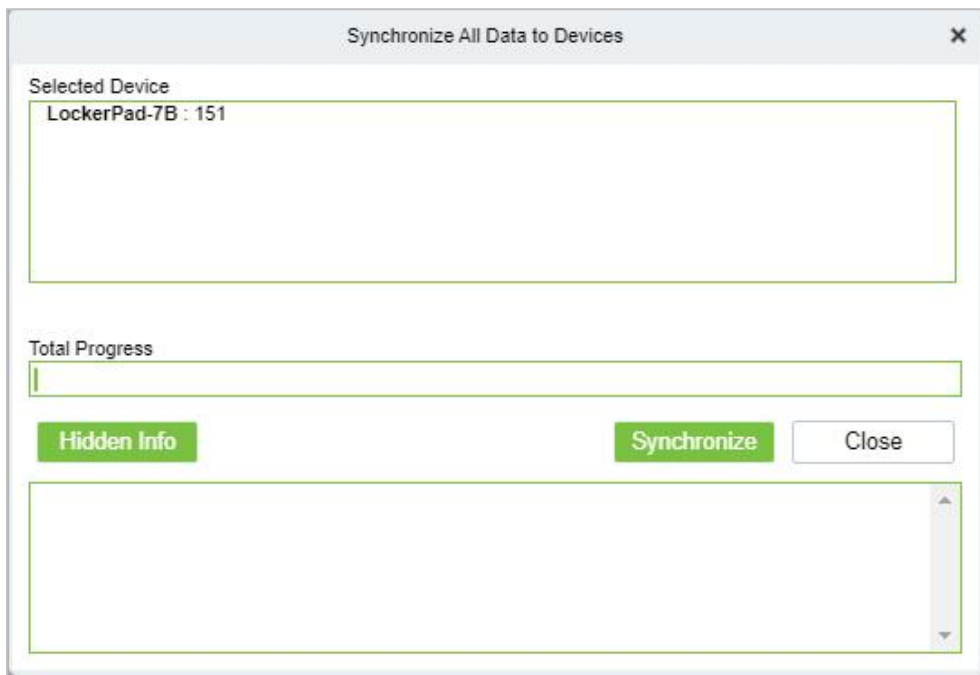

Figure 19- 4 Synchronize All Data to Devices Interface

Distribute Advertising Resources:

Administrator selects the AD resource on the computer and delivers it to lockerpad-7b. Click **Distribute Advertising Resources**, click **Browser**, then select the picture or video and click **OK**.

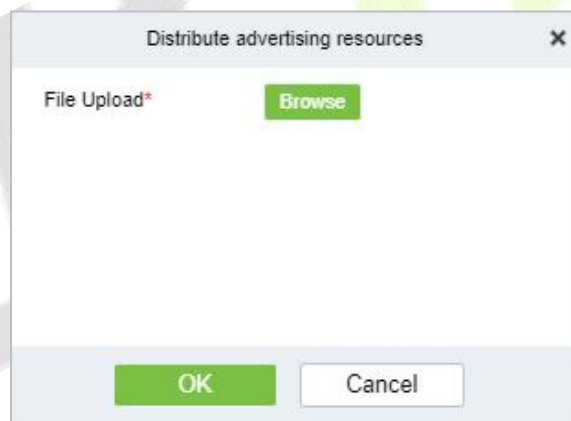

Figure 19- 5 Distribute Advertising Resources Interface

Clear All Ads:

Clears all ads resources from the selected device.

19.1.2 Parameters

In **Locker** module, click Locker **Device Management** > **Parameter** to set the parameters.

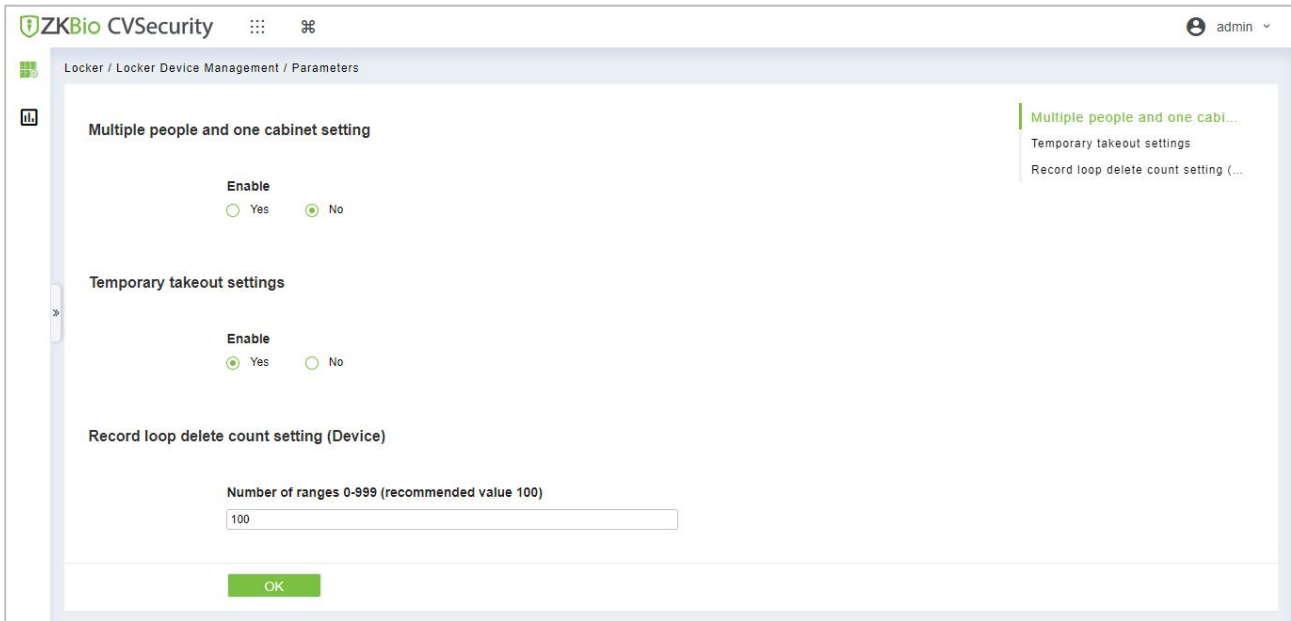

Figure 19- 6 Parameter

Item	Description
Multiple people and one cabinet setting	Multiple users can share a cabinet when it is enabled.
Temporary takeout settings	When enabled, users can remove objects without losing access to the cabinet
Record loop delete count setting (Device)	When a specified number of stored records is reached, a certain number of records will be deleted from the beginning, the number of records you fill in the space.

Table 19- 2 Parameter Description

19.1.3 Visual Panel

In this function, admin can link users in the software to the corresponding cabinet.

Step 1: In the **Locker** module, click **Locker Device Management > Visual Panel**.

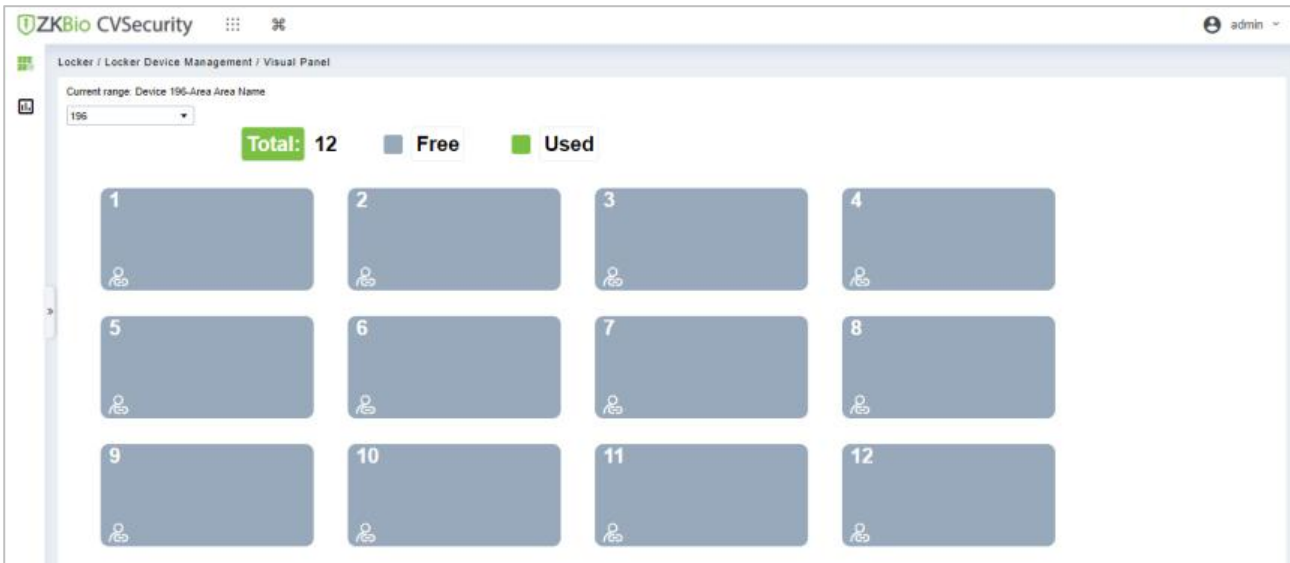

Figure 19- 7 Visual Panel

Step 2: Select a panel, click on  icon, **Selected Person** will pop up.

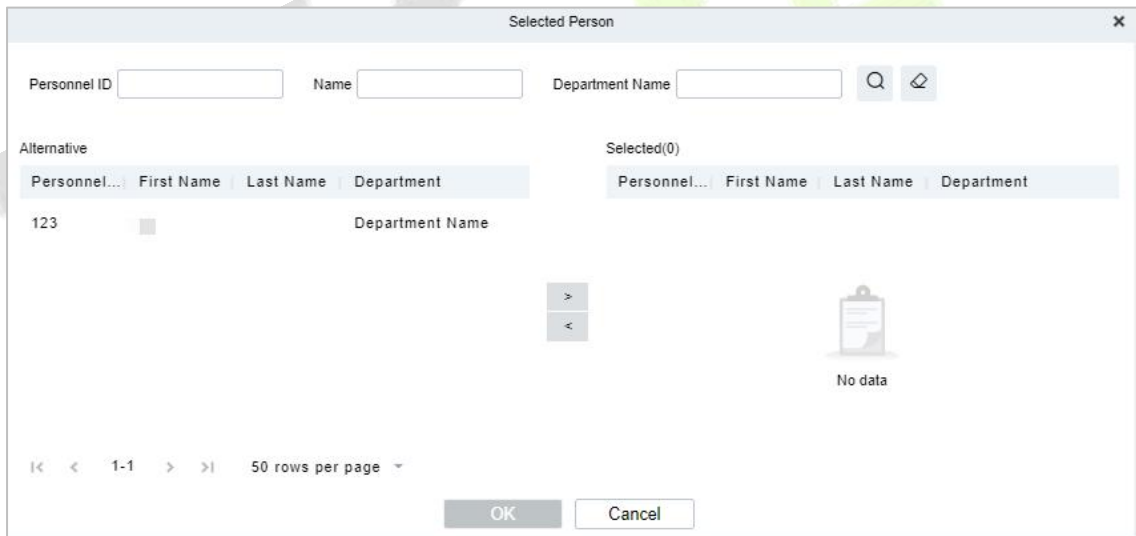

Figure 19- 8 Select Person Interface

Step 3: Select the user that the admin wants to bind with the cabinet. Then click > and **OK**.



Figure 19-9 Visual Panel Interface

Note:

- 1. When you click on **Total**, all cabinets will be displayed.
- 2. When you click on **Free**, all unoccupied cabinets will be displayed.
- 3. When you click on **Used**, all occupied cabinets will be displayed.

19.2 Locker Report

19.2.1 All Transaction

Step 1: Go to **Locker > Locker Report > All transaction**.

Step 2: On the All Records interface, fill in the corresponding query information and click **Search** symbol to complete the query of all records.

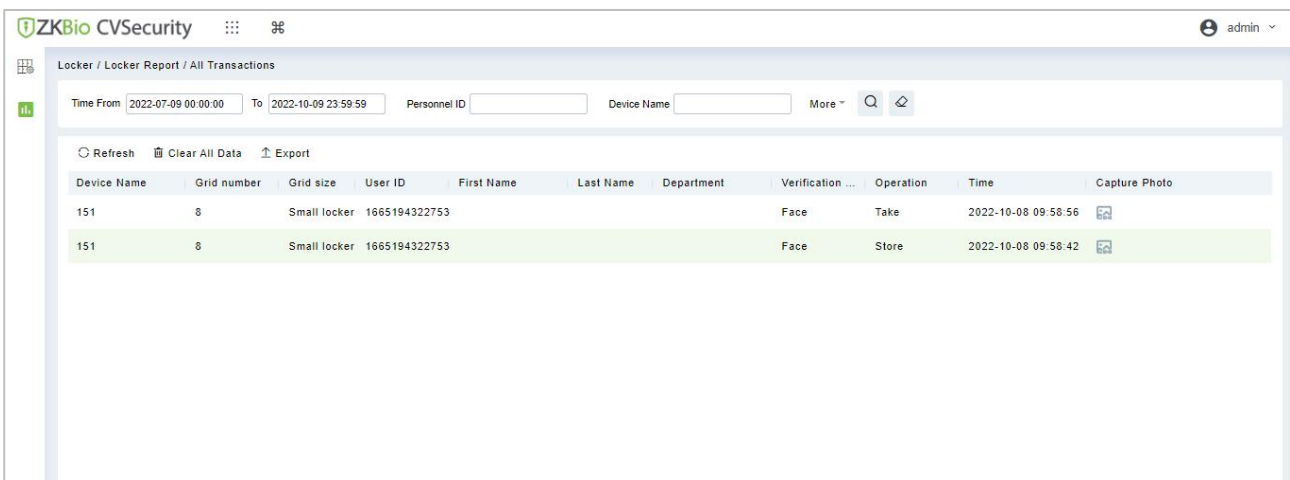

Figure 19- 9 Report Query Page

19.2.1.1 Export

On the **All Records** interface, click **Export**, enter the admin password in the displayed security verification dialog box, and click **OK**. Select whether to encrypt the file and the file format to export, and Click **OK**.

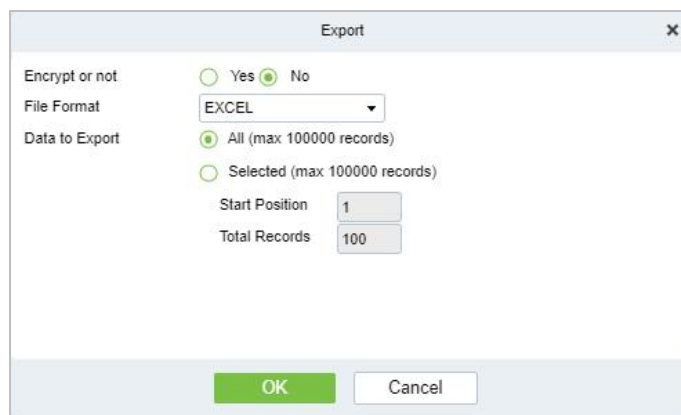

Figure 19- 10 Report Export Page

	A	B	C	D	E	F	G
1	All Transactions						
2	Device Name	Grid number	Grid size	User ID	First Name	Last Name	Department
3	196	1	Small locker	1			
4	196	1	Small locker	1			
5	196	1	Small locker	1665310457633			
6	196	1	Small locker	1665310457633			
7	151	8	Small locker	1665194322753			
8	151	8	Small locker	1665194322753			

Figure 19- 11 Event Export

19.2.1.2 Clear All Data

Click **Clear All Data**, then click **OK** to clear all transactions on the **Prompt** interface.

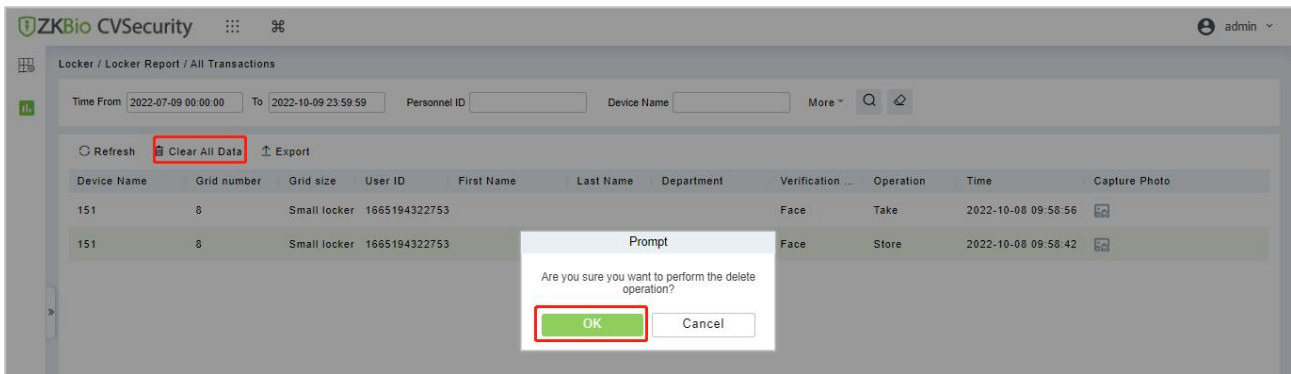

Figure 19- 12 Report Clear All Data

www.zkteco.eu

Copyright © 2022 ZKTECO CO., LTD. All Rights Reserved.